

## DESCRIPTION

The RSA-MRZ family of fixtures is a multi-head, recessed group of products with an integral LED dedicated head. Each head offers four different light levels and lumen packages, with 25°, 40°, and 55° beam spreads. Four color temperatures, 2700K, 3000K, 3500K, 4000K in both 80+ and 97+ CRI are also part of the standard offering. Each head can tilt 45° out of the fixture, and rotate 365° around. The RSA-MRZ family now includes intelligent wireless controls (Enlighted) or simplified wireless controls (WaveLinX), options. Accessories include hex louver, linear spread lens, or soft focus lens. A snoot is also available for high angle glare cutoff.

## SPECIFICATION FEATURES

### Construction

Housing is 6063-T5 extruded aluminum, 20 gauge cold rolled steel. Each head construction is die cast metal. Flanged trim and mud-in trim available. New construction housings equivalent to remodel. Housing constructed by fasteners.

Weights of full fixture assembly:

Flange Trim Weight: 11 lbs

Mud-In Trim Weight: 11.5 lbs

Flange Trim with Sensor Weight: 12 lbs

### Electrical

Standard drivers feature electronic universal voltage (120-277V/ 50-60 Hz), greater than 0.9 power factor, less than

20% harmonic distortion, and features ambient temperature of 25°C (77°F). 0-10V dimming standard.

### LED Optics

Each fixture head features precision molded TIR optics made of virgin optical grade acrylic with 95% efficiency and is field changeable. Each lens is injection molded for precision optics with the choice of 25°, 40°, 55° beam spreads. The LEDs are also offered in 80+ CRI and 97+ CRI in 2700K, 3000K, 3500K, and 4000K CCT.

### Mounting

Housing includes holes for tie back to structure. Knockouts are provided for

Catalog #		Type
Project		
Comments		Date
Prepared by		

threaded rods (by others) to secure fixture to structure. Provide flexible whip or conduit to fixture, and attach to fixture via knock outs on junction box side.

### Finish

Fixture housing is coated using electrostatically charged polyester powder coat paint for superior protection against fade and wear. Paint Colors: B = (All Black) Black Housing/ Black Trim, W = (All White) White Housing/ White Trim. BW = Black Housing/ White Trim. Consult factory for other color options.

### Compliance

Components are UL recognized and luminaires are cULus listed for 25°C ambient environments, IC rated, Chicago plenum rated, and NYC compliant. Dry listed.

### Environment

Suited for indoor only, dry listing. 25° C ambient temperature.

### Control

Standard offering is 0-10V dimming. Energy saving integral sensor options available. Enlighted sensors are available for building management applications. WaveLinX sensors are available for simplified controls solutions. Addressable Lighting Interface (DALI) driver option can be used with Fifth Light Technology.

### Life and Warranty

Standard five-year limited warranty on all parts.



## RSA-MRZ

LED  
Multi-Head Fixture

Recessed  
LED Multi-head Configuration  
2-Head

CERTIFICATION DATA  
UL/cUL Dry Location Listed  
LM-79, LM-80, TM-30, TM-21

ENERGY & CONNECTED SOLUTIONS

WaveLinX  
Enlighted

Top View - Flanged Trim

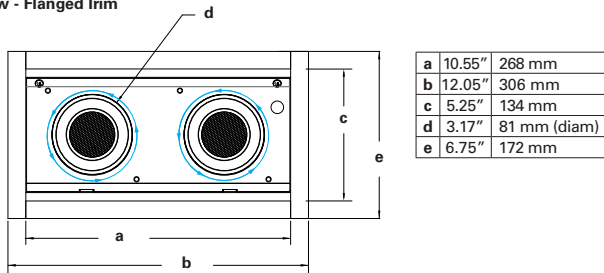

Side View - Flanged Trim

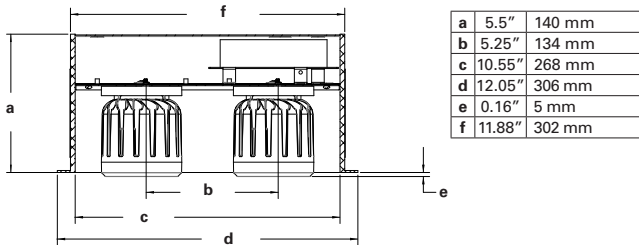

## ORDERING INFORMATION

Sample Number: MRZ-2-REC-MUD-2-L40-80-WFL-UNV-W-DCD-HEX

Series	Size	Mounting	Trim Type <sup>(1)</sup>	Light Level/ Head <sup>(8)</sup> (@ 4000 K)	Color Temp./ Wattage	CRI	Beam Angle	Voltage <sup>(9)</sup>
MRZ = Multi-Head Integral LED	2 = 2 Integral LED Head	REC = Recessed	FLN = Flanged MUD = Mud-In	1 = 650 lumens @5W @80CRI, 500 lumens @5W @ 97CRI 2 = 900 lumens @9W @80CRI, 700 lumens @9W @ 97CRI 3 = 1300 lumens @12W @80CRI, 1000 lumens @12W @ 97CRI 4 = 1700 lumens @16W @80CRI, 1300 lumens @16W @ 97CRI	L27 = 2700K L30 = 3000K L35 = 3500K L40 = 4000K	80+ 97+	NFL = 25° Narrow Flood FL = 40° Flood WFL = 55° Wide Flood	UNV = 120-277V
Finish <sup>(2)</sup>	Drivers <sup>(10)</sup>			Integral Control <sup>(11)(5)(7)</sup> (Optional)	Options <sup>(3)(6)</sup> (Optional)	Accessories <sup>(4)</sup> (Optional Optics Kit)		
W = White Housing/ White Trim B = Black Housing/ Black Trim BW = Black Housing/ White Trim	STD = Standard 0-10V (10%-100%) ELV = Electronic Low Voltage Dimming HCD = 0-10V (1%-100%) DCD = 0-10V (0.1%-100%)	5LTHD = Fifth Light DALI (1-100%) LUH = Lutron H-Series Ecosystem (1-100% Fade to Black)		WAA = WaveLinX Wireless Integral Sensor WAB = WaveLinX Lite Wireless Integral Sensor LWIPD1 = Enlighted Wireless Integral Sensor	REM = Remote Emergency Battery CP = Chicago Plenum HEX = Hex Louver LSL = Linear Spread Lens SFL = Soft Focus Lens SNT = Snoot BF = Butterfly Brackets	K1 = (1) 25°, (1) 40°, (1) 55° lens kit K2 = (2) 25°, (2) 40°, (2) 55° lens kit		

ADDITIONAL OPTIONS AND VIEWS

Mud-in Trim (showing 365° rotation):

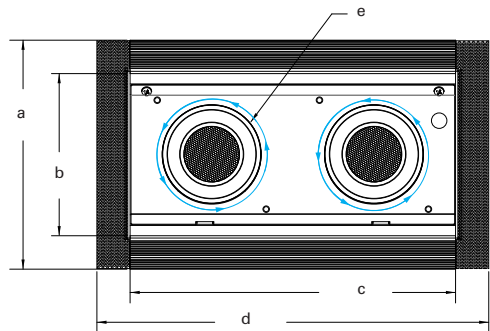

a	7.41"	189 mm
b	5.25"	134 mm
c	10.55"	268 mm
d	12.69"	323 mm
e	3.17"	81 mm (diam)

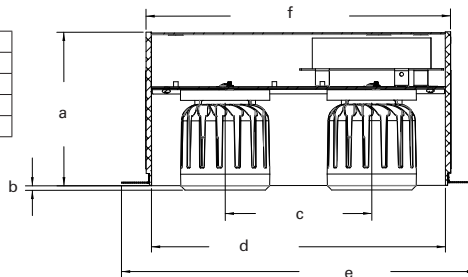

a	5.5"	140 mm
b	0.16"	5 mm
c	5.25"	134 mm
d	10.55"	268 mm
e	12.69"	323 mm
f	11.88"	302 mm

Flange Trim with LumaWatt Pro Sensor LWIPD1 Sensor (WaveLinX sensor, SWPD1, also available)

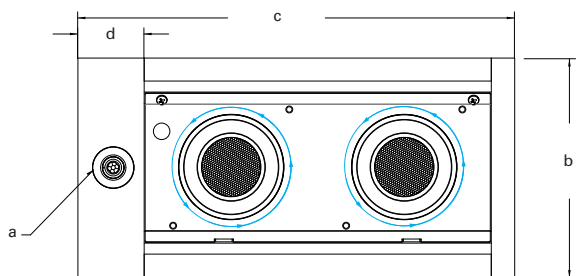

a	1.26"	32 mm (diam)
b	6.65"	169 mm
c	13.25"	337 mm
d	2.0"	52 mm

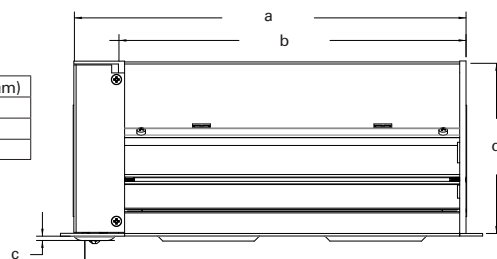

a	12.3"	313 mm
b	11.88"	302 mm
c	0.16"	5 mm
d	5.5"	134 mm

Rotation of 45° per fixture head, and 365°, in plan view.

Accessories - Linear Spread lens, Hex Louver, Soft Focus Lens, Snoot.  
(Note: Only one lens can be used at a time. And, only one lens can be used with snoot)

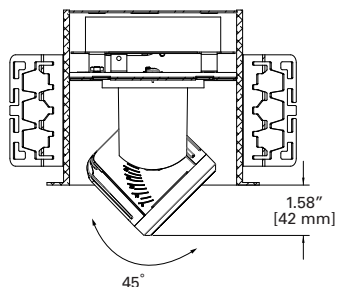

LSL  
Linear Spread Lens

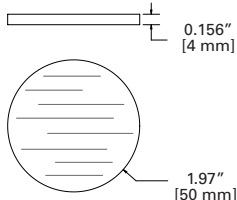

HEX  
Hex Louver

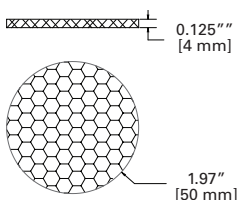

SFL  
Soft Focus Lens

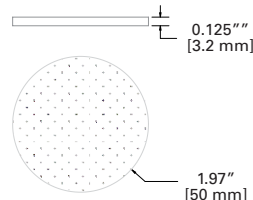

SNT  
Snoot - (Shown with Hex Louver)

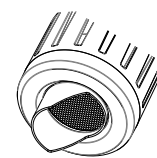

LUMEN MAINTENANCE

AMBIENT TEMPERATURE	TM-21 LUMEN MAINTENANCE (60,000 Hours)	THEORETICAL L70 (Hours)
25°C	> 86%	> 90,000

CONNECTED CONTROL

Enlighted Intelligent (LWIPD1) and WaveLinX (WAA, WAB) Wireless Sensor Ordering Information:

- WAA, WAB and LW sensors must be used with 0-10V drivers (STD, HCD, DCD)
- The WaveLinX integrated sensors (WAA, WAB) offer passive infrared (PIR) occupancy and a photocell for closed loop daylighting.
- See RSA MRZ brochure for systems information and application.

PHOTOMETRY

MRZ 1-HEAD - NARROW FLOOD (25°)	
Filename	MRZ-1-REC-X-4-L35-97-NFL-UNV-X-STD.ies
Test No.	P219571
Lumcat	MRZ-1-REC-X-4-L35-97-NFL-UNV-X-STD
Lumens	1276 Lm
Watts	15.8 W
LPW	80.8 Lm/W
CCT	3500K
SC (0/90/45)	0.41 / 0.41 / 0.37
Beam Angle	24.1°
CBCP	6600 cd

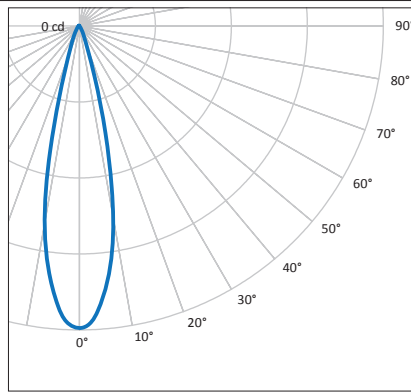

ZONAL LUMENS SUMMARY		
Zone	Lumens	% Fixture
0-30°	1190	93.2
0-40°	1248	97.8
0-60°	1273	99.8
0-90°	1276	100
90-180°	0	0
0-180°	1276	100

LUMINANCE DATA (cd/M <sup>2</sup> )				
Angle	0°	45°	90°	
45	18351	18351	18351	
55	4989	4989	4989	
65	1751	1751	1751	
75	2859	2859	2859	
85	0	0	0	

TM-30-15	R <sub>f</sub> = 90.1	
	R <sub>g</sub> = 97.2	
CRI/CIE	R <sub>a</sub> = 97.3	
	R <sub>g</sub> = 94.4	

CONE OF LIGHT

0° AIMING ANGLE HORIZONTAL ILLUMINANCE ON FLOOR				
MH	FC	L	W	
1'				
5'	264	2	2	
5.5'	218.2	2.2	2.2	
6.5'	156.2	2.6	2.6	
7.5'	117.3	3	3	

30° AIMING ANGLE HORIZONTAL ILLUMINANCE ON FLOOR					
MH	FC	L	W	CB	
1'					
5'	180	2.5	2.2	2.9	
5.5'	148.8	2.7	2.4	3.2	
6.5'	106.5	3.2	3	3.8	
7.5'	80	3.7	3.4	4.3	

30° AIMING ANGLE VERTICAL ILLUMINANCE ON WALL				
MH	FC	L	W	CB
1'	1177.3	0.9	0.6	1.7
1.5'	523.3	1.4	1	2.6
2'	294.3	1.9	1.2	3.5
2.5'	188.4	2.4	1.6	4.3
3'	130.8	2.9	2	5.2
3.5'	96.1	3.3	2.4	6.1

COLOR VECTOR GRAPHIC

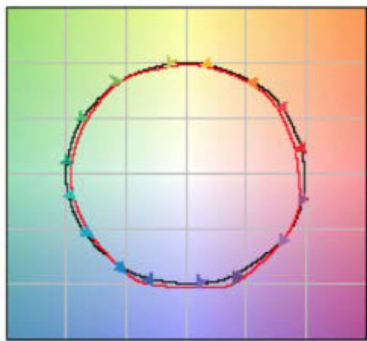

Reference Illuminant Test Source

MRZ 1-HEAD - FLOOD (40°)	
Filename	MRZ-1-REC-X-4-L35-97-FL-UNV-X-STD.ies
Test No.	P219726
Lumcat	MRZ-1-REC-X-4-L35-97-FL-UNV-X-STD
Lumens	1283 Lm
Watts	15.8 W
LPW	81.2 Lm/W
CCT	3500K
SC (0/90/45)	0.7 / 0.7 / 0.66
Beam Angle	42.3°
CBCP	2347 cd

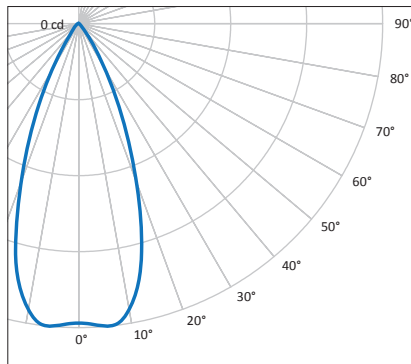

ZONAL LUMENS SUMMARY		
Zone	Lumens	% Fixture
0-30°	1103	86
0-40°	1229	95.8
0-60°	1275	99.4
0-90°	1283	100
90-180°	0	0
0-180°	1283	100

LUMINANCE DATA (cd/M <sup>2</sup> )				
Angle	0°	45°	90°	
45	28538	28538	28538	
55	11354	11354	11354	
65	5137	5137	5137	
75	2859	2859	2859	
85	0	0	0	

TM-30-15	R <sub>f</sub> = 90.1	
	R <sub>g</sub> = 97.2	
CRI/CIE	R <sub>a</sub> = 97.3	
	R <sub>g</sub> = 94.4	

CONE OF LIGHT

0° AIMING ANGLE HORIZONTAL ILLUMINANCE ON FLOOR				
MH	FC	L	W	
1'				
5'	94.3	3.4	3.4	
5.5'	77.9	3.8	3.8	
6.5'	55.8	4.4	4.4	
7.5'	41.9	5.2	5.2	

30° AIMING ANGLE HORIZONTAL ILLUMINANCE ON FLOOR					
MH	FC	L	W	CB	
1'					
5'	75.7	3.7	3.6	2.9	
5.5'	62.6	4	3.8	3.2	
6.5'	44.8	4.8	4.6	3.8	
7.5'	33.7	5.6	5.4	4.3	

30° AIMING ANGLE VERTICAL ILLUMINANCE ON WALL				
MH	FC	L	W	CB
1'	674.3	0.9	0.8	1.7
1.5'	299.7	1.4	1.2	2.6
2'	168.6	1.9	1.8	3.5
2.5'	107.9	2.4	2.2	4.3
3'	74.9	2.9	2.6	5.2
3.5'	55	3.4	3	6.1

COLOR VECTOR GRAPHIC

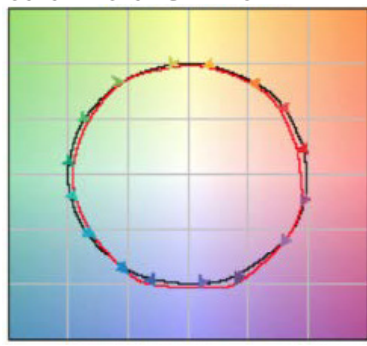

Reference Illuminant Test Source

MRZ 1-HEAD - WIDE FLOOD (55°)	
Filename	MRZ-1-REC-X-4-L35-97-WFL-UNV-X-STD.ies
Test No.	P219850
Lumcat	MRZ-1-REC-X-4-L35-97-WFL-UNV-X-STD
Lumens	1194 Lm
Watts	15.8 W
LPW	75.6 Lm/W
CCT	3500K
SC (0/90/45)	0.91 / 0.91 / 0.91
Beam Angle	60.7°
CBCP	1198 cd

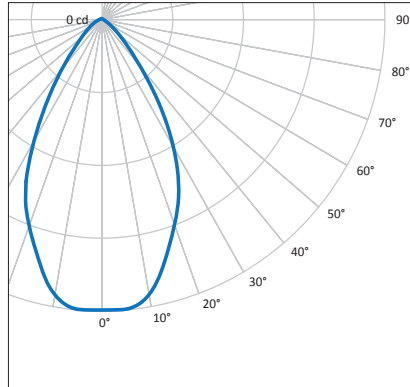

ZONAL LUMENS SUMMARY		
Zone	Lumens	% Fixture
0-30°	755	63.2
0-40°	1016	85.1
0-60°	1180	98.8
0-90°	1194	100
90-180°	0	0
0-180°	1194	100

LUMINANCE DATA (CD/M <sup>2</sup> )			
Angle	0°	45°	90°
45	105010	105010	105010
55	40256	40256	40256
65	11908	11908	11908
75	5528	5528	5528
85	0	0	0

TM-30-15	R <sub>f</sub> = 90.1
	R <sub>g</sub> = 97.2
CRI/CIE	R <sub>a</sub> = 97.3
	R <sub>g</sub> = 94.4

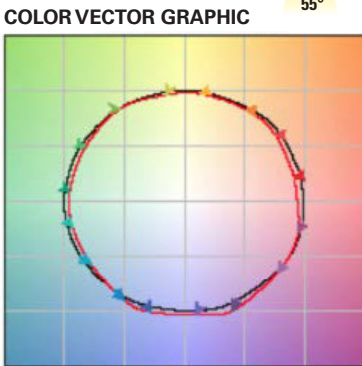
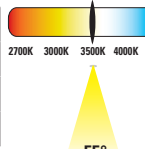

CONE OF LIGHT

0° AIMING ANGLE HORIZONTAL ILLUMINANCE ON FLOOR				
MH	FC	L	W	
5'	47.9	4.4	4.4	
5.5'	39.6	5	5	
6.5'	28.4	5.8	5.8	
7.5'	21.3	6.8	6.8	

30° AIMING ANGLE HORIZONTAL ILLUMINANCE ON FLOOR				
MH	FC	L	W	CB
5'	38.3	4.5	4.6	2.9
5.5'	31.6	5.1	5.2	3.2
6.5'	22.6	6	6	3.8
7.5'	17	6.9	7	4.3

30° AIMING ANGLE VERTICAL ILLUMINANCE ON WALL				
MH	FC	L	W	CB
1'	429	1	1	1.7
1.5'	190.6	1.5	1.6	2.6
2'	107.2	2.1	2.2	3.5
2.5'	68.6	2.6	2.8	4.3
3'	47.7	3.2	3.2	5.2
3.5'	35	3.8	3.8	6.1

MULTIPLIER TABLE								
CRI	80+				97+			
CCT	2700K	3000K	3500K	4000K	2700K	3000K	3500K	4000K
MULTIPLIER	1.226	1.246	1.314	1.332	0.875	0.957	1.000	1.039

TECHNICAL NOTES

- Sensor only available for Flange Trim.
- W = (White) White Housing, White Trim. B = (Black) Black Housing, Black Trim. BW = Black Housing, White Trim. Consult factory for custom colors.
- When SFL, LSL, HEX, or SNT are selected, all fixture heads receive this option. Only one shielding media can be used at a time. However, the SNT (snoot) option can take one hex louver, linear spread, or soft focus lens media.
- K1 is a kit that contains one 25°, one 40°, and one 55° lens in one box for field changeable optic distributions. K2 is a kit that contains two 25°, two 40°, and two 55° lenses in one box for field changeable optic distributions. K3 is a kit that contains three 25°, three 40°, and three 55° lenses in one box for field changeable optic distributions. K4 is a kit that contains four 25°, four 40°, and four 55° lenses in one box for field changeable optic distributions.
- See CONNECTED CONTROL for detailed information and full specification.
- 7W Surelite battery. Each fixture head will dim to 50% of output for egress mode.
- Integral sensors are only compatible with 0-10V dimming drivers. They must be used with their respective wireless control systems.
- Refer to "IES Files" section for all options of color temperatures, CRIs, optical distributions, and shielding media.
- 347 V not available
- Driver Table availability for 2-Head:

DRIVER AVAILABILITY TABLE - 2 HEAD							
LIGHT LEVEL	STD 0-10V (10-100%)	ELV Electronic Low Voltage	HCD (1-100%)	DCD (0.1-100%)	5LT Fifth Light Dali (5-100%)	5LTHD Fifth Light Dali (1-100%)	LUH Lutron-EcoSys (1-100%)
1	YES	YES	NO	YES	NO	YES	YES
2	YES	YES	YES	YES	NO	YES	YES
3	YES	YES	YES	YES	NO	YES	YES
4	YES	YES	YES	YES	NO	YES	YES