

DESCRIPTION

Recessed 4" aperture ultra-shallow install from below remodeler type housing for line voltage LED or halogen PAR16 lamps. Suitable for 2x4 residential framing or shallow plenum commercial construction, meets restrictive airflow requirements and can be used in direct contact with insulation. Use with compatible Halo™ trims and PAR16 lamps (by others) providing a broad range of trim styles and optical distributions.

Catalog #		Type
Project		
Comments		Date
Prepared by		

SPECIFICATION FEATURES

Housing

- Single wall deep drawn aluminum housing painted matte black for a visually dark interior
- Accommodates ceilings from 3/8" to 1-1/4" thick
- Shipped with overspray protector installed

Mounting Springs

- Captive preinstalled mounting springs retain housing securely in ceiling.
- Housing can be removed from below the ceiling for service or splice inspection

Gasket

- Closed cell gaskets achieve restrictive airflow requirements without additional gaskets or caulking

Junction Box

- Compact galvanized steel junction box with 10in³ internal volume
- Listed for (6) #12 AWG 90° C splice conductors
- Hinged door is retained and provides easy access to field wiring
- (3) 1/2" conduit pry-outs

- (3) Slide-N-Side™ non-metallic (NM) wire traps allows wiring outside the box
- Accepts 14-2, 14-3, 12-2, 12-3 U.S. and 14-2, 14-3, 12-2 Canadian NM cable
- Quick Connect™ remodel wiring tray holds (3) 4-port
- push wire nuts facilitating mains voltage connections

Socket

- GU10 socket for 120V LED or halogen PAR16 lamps

Trims

- Compatible with a broad range of trim styles and optical distributions
- Friction blades hold trim tight to ceiling surface, gasket minimizes light leaks
- Use with full overlap or die cast flange styles

Compliance

- Type IC thermally protected, suitable for direct contact to air permeable insulation and cULus listed for damp locations
- Not for use in direct contact with spray foam insulation, consult NEMA LSD57-2013

- Wet location listed in covered ceilings and IP44 certified with select lens trims
- Airtight per ASTM-E283
- Can be used for State of California Title 24 high efficacy luminaire compliance with designated trims and CAT24-2016-E labeled lamps
- Suitable for use in clothes closets when installed in accordance with the NEC 410.16 spacing requirements
- Contains no mercury or lead and RoHS compliant

Warranty

- One year limited warranty, consult website for details. www.cooperlighting.com



E44PAR16RICAT

4" Ultra-Shallow Recessed Line Voltage Remodeler Housing

**4" LED PAR16 Trims
10W Maximum**



ENERGY DATA

Input Voltage	120V
Input Current	(mA)
Input Power	(W)
Efficiency	(LPW)
Inrush (A)	(A)
THD: ≤ 20%	
PF: ≥ 0.90	
T Ambient -40 - +40°C	
Sound Rating ≤ 20dba	

Special Features

Quick Connect™ push wire nuts
Air-Tite™ code compliant

DIMENSIONS

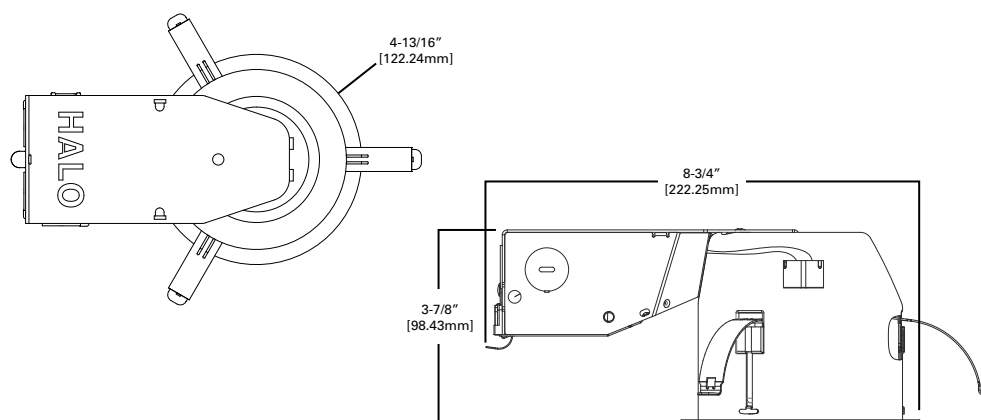

ORDERING INFORMATION

A complete luminaire consists of a housing, lamp (by others) and trim. Ordered separately.







Housing	Options	Trims	Accessories
E44PAR16RICAT = 4" ultra-shallow recessed remodeler housing, GU10 base, 120V	DR10 = De-rated to 10W, for LED MR16 lamps only	See below	L100 Series = Accessory 2" filters and lens, see specification sheet for details OT999P = Oversized trim ring accessory

'Full Overlap' Self Flanged MR16 Trim



Use with new construction and install from below remodeler type housing types

20W Maximum / GU10 Base

Directional Open

	1440 Conical Reflector, Open, 35° Tilt 1440MWWF=Matte White, White Flange 1440H=Haze 1440HWF=Haze, White Flange 1440BN=Brushed Nickel 1440GB=German Bronze		1444 Round Pinhole, Open, 35° Tilt 1444MW=Matte White 1444MB=Matte Black 1444BN=Brushed Nickel 1444GB=German Bronze		1484 Square Pinhole, Open, 35° Tilt 1484MW=Matte White 1484MB=Matte Black 1484BN=Brushed Nickel 1484GB=German Bronze
	1441 Conical Baffle, Open, 35° Tilt 1441MBWF=White Baffle, White Flange 1441BBWF=Black Baffle, White Flange 1441BN=Brushed Nickel 1441GB=German Bronze		1445 Round Pinhole with Oculus, Open, 35° Tilt 1445MWWB=Matte White, White Baffle 1445MWBB=Matte White, Black Baffle 1445BNBB=Brushed Nickel, Black Baffle 1445GBBB=German Bronze, Black Baffle		1485 Square Pinhole with Oculus, Open, 35° Tilt 1485MWWB=Matte White, White Baffle 1485MWBB=Matte White, Black Baffle 1485BNBB=Brushed Nickel, Black Baffle 1485GBBB=German Bronze, Black Baffle

Lens Wall Wash

	1442 Angle Cut Conical Reflector, Lens Wall Wash 1442MWWF=Matte White, White Flange 1442H=Haze 1442HWF=Haze, White Flange		1446 Round Pinhole, Lens Wall Wash 1446MWWB=Matte White, White Baffle 1446MWBB=Matte White, Black Baffle		1486 Square Pinhole, Lens Wall Wash 1486MWWB=Matte White, White Baffle 1486MWBB=Matte White, Black Baffle
---	---	---	---	---	--

Directional Lens

	1443 Conical Reflector, Diffuse Lens, 35° Tilt 1443MWWF=Matte White, White Flange 1443H=Haze 1443HWF=Haze, White Flange 1443BN=Brushed Nickel 1443GB=German Bronze		1449 Round 'All Acrylic-Glass' Diffuse Lens, 35° Tilt 1449AAG=All Acrylic Glass		1489 Square 'All Acrylic-Glass' Diffuse Lens, 35° Tilt 1489AAG=All Acrylic Glass
	1447 Round Pinhole, Diffuse Lens, 35° Tilt 1447MWWB=Matte White, White Baffle 1447MWBB=Matte White, Black Baffle 1447BNBB=Brushed Nickel, Black Baffle 1447GBBB=German Bronze, Black Baffle		1487 Square Pinhole, Diffuse Lens, 35° Tilt 1487MWWB=Matte White, White Baffle 1487MWBB=Matte White, Black Baffle 1487BNBB=Brushed Nickel, Black Baffle 1487GBBB=German Bronze, Black Baffle		

- Lens trims are wet location listed, covered ceilings only and IP44 rated
- Unless otherwise noted lamp rotates 360°, tilts 35° from nadir and adjusts from above and/or below the ceiling without tools holding any aiming angle

Die Cast Metal Trim Rings MR16 Trim

Use with new construction and install from below remodeler type housing types

20W Maximum / GU10 Base

	1421 Precision Reflector, 35° Tilt 1421MB=Matte Black 1421W=White 1421H=Haze 1421C=Clear Specular 1421RG=Residential Gold 1421CG=Champagne Gold 1421SN=Satin Nickel 1421TBZ=Tuscan Bronze		1420 Adjustable Slot Aperture, 35° Tilt 1420P=White 1420SN=Satin Nickel 1420TBZ=Tuscan Bronze		1951 Regressed Clear Glass Showerlight, 15° Tilt 1951PS=White Trim, Clear Specular Splay 1951SNS=Satin Nickel, Clear Specular Splay 1951TBZS=Tuscan Bronze, Clear Specular Splay
	1419 Pinhole Baffle 1419W=White Baffle, White Trim 1419P=Black Baffle, White Trim 1419SN=Black Baffle, Satin Nickel Trim 1419TBZ=Black Baffle, Tuscan Bronze Trim		1493 Coilex® Baffle, 35° Tilt 1493W=White Baffle, Trim 1493P=Black Baffle, White Trim 1493BC=Black Baffle, Black Chrome Trim 1493SN=Black Baffle, Satin Nickel Trim 1493TBZ=Black Baffle, Tuscan Bronze Trim		1496 Retractable Elbow, 60° Tilt 1496P=White 1496SN=Satin Nickel 1496TBZ=Tuscan Bronze
	1453 Precision Metal Baffle, 35° Tilt 1453SN=Satin Nickel Baffle, Trim 1453TBZ=Tuscan Bronze Baffle, Trim		1495 Adjustable Mirror Trim, 90° Tilt 1495P=White Gimbal, Trim 1495SN=Satin Nickel Gimbal, Trim 1495TBZ=Tuscan Bronze Gimbal, Trim		1498 Adjustable Eyeball with Baffle, 30° Tilt 1498W=White Trim, Baffle 1498P=White Trim, Black Baffle 1498BC=Black Chrome Trim, Black Baffle 1498SN=Satin Nickel Trim, Black Baffle 1498TBZ=Tuscan Bronze Trim, Black Baffle
			1497 Adjustable Mirror Trim, 90° Tilt 1497P=White Trim, Scoop		

PHOTOMETRICS - DIRECTIONALS

Notes and Definitions:

Luminance: To convert cd/m² to footlamberts, multiply by 0.2919

• Beam spread is to 50% center beam candlepower (CBCP)

• Data shown is based on bare lamp photometrics.

D=Distance to floor or wall.

FC=Footcandles on floor or wall at center beam aiming location.

L=Effective Visual Beam length in feet (50% of maximum footcandle level.)

W=Effective Visual Beam width in feet (50% of maximum footcandle level.)

CB=Distance across or down to center beam location.

The "real world photometrics" shown here are from off the shelf lamps in fixtures using a clear lens and operated at 12.0 volts. Please see page 64 & 65 of the IRIS catalog for a further discussion and appropriate correction multipliers.

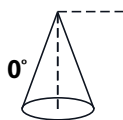
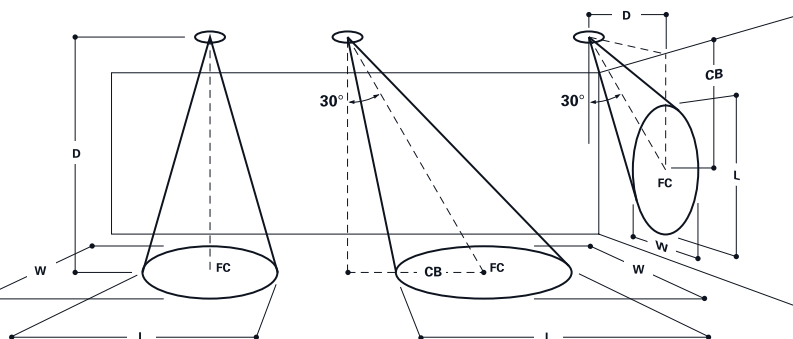

Trims	Lamp	0° Aiming Angle Horizontal Footcandles				30° Aiming Angle Horizontal Footcandles					30° Aiming Angle Vertical Footcandles				
		MH	FC	L	W	MH	FC	L	W	CB	MH	FC	L	W	CB
1440MWWF	7MR16 EXPERTCOLOR S10 930 D 10/1 Lumens: 481lm Beam Angle: 9.8° CBCP: 6258cd	6'	167.7	1	1	6'	95.9	1.4	1	3.5	2'	209.6	1.2	0.6	3.5
		8'	94.3	1.2	1.2	8'	54	1.9	1.4	4.6	3'	93.2	1.8	0.8	5.2
		10'	60.4	1.6	1.6	10'	34.5	2.3	1.8	5.8	4'	52.4	2.5	1.2	6.9
		12.5'	38.6	2	2	12.5'	22.1	2.9	2.4	7.2	5'	33.5	3.1	1.4	8.7
		Test #: G1-1804-707-1		Test #: G1-1804-707-12					Test #: G1-1804-707-12						
1440MWWF	7MR16 EXPERTCOLOR F25 930 D 10/1 Lumens: 497lm Beam Angle: 20.8° CBCP: 2526cd	6'	67.1	2	2	6'	45.4	2.7	2.2	3.5	2'	98.9	2	1.2	3.5
		8'	37.7	2.8	2.8	8'	25.5	3.5	3	4.6	3'	44	3	1.8	5.2
		10'	24.1	3.4	3.4	10'	16.3	4.5	3.8	5.8	4'	24.7	4	2.4	6.9
		12.5'	15.4	4.4	4.4	12.5'	10.5	5.6	4.8	7.2	5'	15.8	5.1	3	8.7
		Test #: G1-1804-707-23		Test #: G1-1804-707-37					Test #: G1-1804-707-37						
1440MWWF	7MR16 EXPERTCOLOR F35 930 D 10/1 Lumens: 487lm Beam Angle: 30.6° CBCP: 1457cd	6'	39.2	3	3	6'	27.7	3.6	3.4	3.5	2'	67.3	2.1	1.6	3.5
		8'	22	4	4	8'	15.6	4.8	4.4	4.6	3'	29.9	3.2	2.4	5.2
		10'	14.1	5	5	10'	10	6.1	5.6	5.8	4'	16.8	4.3	3.2	6.9
		12.5'	9	6.2	6.2	12.5'	6.4	7.6	7	7.2	5'	10.8	5.5	4	8.7
		Test #: G1-1804-707-48		Test #: G1-1804-707-59					Test #: G1-1804-707-59						

PHOTOMETRICS - DIRECTIONALS (CONTINUED)

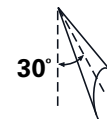
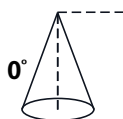

Trims	Lamp	0° Aiming Angle Horizontal Footcandles				30° Aiming Angle Horizontal Footcandles					30° Aiming Angle Vertical Footcandles				
		MH	FC	L	W	MH	FC	L	W	CB	MH	FC	L	W	CB
1441WBWF	7MR16 EXPERTCOLOR S10 930 D 10/1 Lumens: 481lm Beam Angle: 9.8° CBCP: 6258cd	6'	167.3	1	1	6'	101.2	1.3	1	3.5	2'	192.4	1.3	0.6	3.5
		8'	94.1	1.2	1.2	8'	57	1.8	1.4	4.6	3'	85.5	2	0.8	5.2
		10'	60.2	1.6	1.6	10'	36.4	2.2	1.8	5.8	4'	48.1	2.7	1.2	6.9
		12.5'	38.5	2	2	12.5'	23.3	2.9	2.4	7.2	5'	30.8	3.3	1.6	8.7
		Test #: G1-1804-707-2				Test #: G1-1804-707-13					Test #: G1-1804-707-13				
	7MR16 EXPERTCOLOR F25 930 D 10/1 Lumens: 497lm Beam Angle: 20.8° CBCP: 2526cd	6'	68.4	2	2	6'	45.5	2.6	2.2	3.5	2'	100.5	2	1.2	3.5
		8'	38.5	2.8	2.8	8'	25.6	3.5	3	4.6	3'	44.7	3	1.8	5.2
		10'	24.6	3.4	3.4	10'	16.4	4.4	3.8	5.8	4'	25.1	4	2.4	6.9
		12.5'	15.8	4.4	4.4	12.5'	10.5	5.5	4.8	7.2	5'	16.1	5	3	8.7
		Test #: G1-1804-707-24				Test #: G1-1804-707-38					Test #: G1-1804-707-38				
	7MR16 EXPERTCOLOR F35 930 D 10/1 Lumens: 487lm Beam Angle: 30.6° CBCP: 1457cd	6'	39.1	3	3	6'	27.1	3.6	3.4	3.5	2'	69.3	2	1.4	3.5
		8'	22	4	4	8'	15.2	4.9	4.4	4.6	3'	30.8	3.1	2.4	5.2
		10'	14.1	5	5	10'	9.8	6.1	5.6	5.8	4'	17.3	4.1	3.2	6.9
		12.5'	9	6.2	6.2	12.5'	6.2	7.7	7	7.2	5'	11.1	5.2	4	8.7
		Test #: G1-1804-707-49				Test #: G1-1804-707-60					Test #: G1-1804-707-60				
1444MW	7MR16 EXPERTCOLOR S10 930 D 10/1 Lumens: 481lm Beam Angle: 9.8° CBCP: 6258cd	6'	162.4	1	1	6'	97.4	1.3	1	3.5	2'	192.2	1.2	0.6	3.5
		8'	91.4	1.4	1.4	8'	54.8	1.8	1.4	4.6	3'	85.4	1.9	0.8	5.2
		10'	58.5	1.6	1.6	10'	35.1	2.2	1.8	5.8	4'	48.1	2.6	1.2	6.9
		12.5'	37.4	2	2	12.5'	22.4	2.8	2.2	7.2	5'	30.8	3.3	1.4	8.7
		Test #: G1-1804-707-4				Test #: G1-1804-707-15					Test #: G1-1804-707-15				
	7MR16 EXPERTCOLOR F25 930 D 10/1 Lumens: 497lm Beam Angle: 20.8° CBCP: 2526cd	6'	66.6	2	2	6'	45.8	2.5	2.2	3.5	2'	90.9	2	1.2	3.5
		8'	37.4	2.8	2.8	8'	25.8	3.4	3	4.6	3'	40.4	3.1	1.8	5.2
		10'	24	3.4	3.4	10'	16.5	4.2	3.8	5.8	4'	22.7	4.1	2.4	6.9
		12.5'	15.3	4.2	4.2	12.5'	10.6	5.3	4.8	7.2	5'	14.5	5.3	3	8.7
		Test #: G1-1804-707-27				Test #: G1-1804-707-40					Test #: G1-1804-707-40				
	7MR16 EXPERTCOLOR F35 930 D 10/1 Lumens: 487lm Beam Angle: 30.6° CBCP: 1457cd	6'	38.4	3	3	6'	27.2	3.5	3.4	3.5	2'	65	2	1.6	3.5
		8'	21.6	4	4	8'	15.3	4.7	4.4	4.6	3'	28.9	3	2.4	5.2
		10'	13.8	5	5	10'	9.8	5.9	5.6	5.8	4'	16.3	4.1	3.2	6.9
		12.5'	8.8	6.2	6.2	12.5'	6.3	7.3	7	7.2	5'	10.4	5	4	8.7
		Test #: G1-1804-707-51				Test #: G1-1804-707-62					Test #: G1-1804-707-62				

PHOTOMETRICS - DIRECTIONALS (CONTINUED)

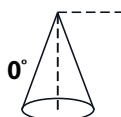

Trims	Lamp	0° Aiming Angle Horizontal Footcandles				30° Aiming Angle Horizontal Footcandles					30° Aiming Angle Vertical Footcandles				
		MH	FC	L	W	MH	FC	L	W	CB	MH	FC	L	W	CB
1445MWWB	7MR16 EXPERTCOLOR S10 930 D 10/1 Lumens: 481lm Beam Angle: 9.8° CBCP: 6258cd	6'	168.5	1	1	6'	97.6	1.3	1	3.5	2'	169.6	1.4	0.6	3.5
		8'	94.8	1.2	1.2	8'	54.9	1.8	1.4	4.6	3'	75.4	2.1	0.8	5.2
		10'	60.7	1.6	1.6	10'	35.2	2.3	1.8	5.8	4'	42.4	2.8	1.2	6.9
		12.5'	38.8	2	2	12.5'	22.5	2.8	2.2	7.2	5'	27.1	3.6	1.6	8.7
		Test #: G1-1804-707-5				Test #: G1-1804-707-16					Test #: G1-1804-707-16				
	7MR16 EXPERTCOLOR F25 930 D 10/1 Lumens: 497lm Beam Angle: 20.8° CBCP: 2526cd	6'	67.1	2	2	6'	45.4	2.5	2.2	3.5	2'	94.1	1.9	1.2	3.5
		8'	37.7	2.6	2.6	8'	25.5	3.3	3	4.6	3'	41.8	3	1.8	5.2
		10'	24.2	3.4	3.4	10'	16.3	4.3	3.8	5.8	4'	23.5	4	2.4	6.9
		12.5'	15.5	4.2	4.2	12.5'	10.5	5.3	4.8	7.2	5'	15.1	5	3	8.7
		Test #: G1-1804-707-28				Test #: G1-1804-707-41					Test #: G1-1804-707-41				
	7MR16 EXPERTCOLOR F35 930 D 10/1 Lumens: 487lm Beam Angle: 30.6° CBCP: 1457cd	6'	39.2	3	3	6'	27.3	3.5	3.4	3.5	2'	66.3	1.9	1.6	3.5
		8'	22.1	4	4	8'	15.3	4.8	4.6	4.6	3'	29.5	3	2.4	5.2
		10'	14.1	5	5	10'	9.8	6	5.6	5.8	4'	16.6	4	3.2	6.9
		12.5'	9	6.2	6.2	12.5'	6.3	7.5	7.2	7.2	5'	10.6	5.1	4	8.7
		Test #: G1-1804-707-52				Test #: G1-1804-707-63					Test #: G1-1804-707-63				
1484MW	7MR16 EXPERTCOLOR S10 930 D 10/1 Lumens: 481lm Beam Angle: 9.8° CBCP: 6258cd	6'	166.4	1	1	6'	95	1.4	1	3.5	2'	197.9	1.2	0.6	3.5
		8'	93.6	1.4	1.4	8'	53.4	1.8	1.4	4.6	3'	87.9	1.8	0.8	5.2
		10'	59.9	1.6	1.6	10'	34.2	2.3	1.8	5.8	4'	49.5	2.5	1.2	6.9
		12.5'	38.3	2.2	2.2	12.5'	21.9	2.9	2.4	7.2	5'	31.7	3.2	1.4	8.7
		Test #: G1-1804-707-8				Test #: G1-1804-707-19					Test #: G1-1804-707-19				
	7MR16 EXPERTCOLOR F25 930 D 10/1 Lumens: 497lm Beam Angle: 20.8° CBCP: 2526cd	6'	66.7	2	2	6'	44.7	2.5	2.2	3.5	2'	98.6	1.9	1.2	3.5
		8'	37.5	2.8	2.6	8'	25.1	3.4	3	4.6	3'	43.8	2.9	1.8	5.2
		10'	24	3.4	3.4	10'	16.1	4.2	3.8	5.8	4'	24.6	4	2.4	6.9
		12.5'	15.4	4.4	4.2	12.5'	10.3	5.4	4.8	7.2	5'	15.8	5	3	8.7
		Test #: G1-1804-707-32				Test #: G1-1804-707-44					Test #: G1-1804-707-44				
	7MR16 EXPERTCOLOR F35 930 D 10/1 Lumens: 487lm Beam Angle: 30.6° CBCP: 1457cd	6'	39.7	2.8	3	6'	27.5	3.5	3.4	3.5	2'	65.3	2.1	1.6	3.5
		8'	22.3	3.8	4	8'	15.4	4.7	4.6	4.6	3'	29	3.1	2.4	5.2
		10'	14.3	4.8	5	10'	9.9	5.9	5.6	5.8	4'	16.3	4.2	3.2	6.9
		12.5'	9.1	6.2	6.2	12.5'	6.3	7.5	7	7.2	5'	10.4	5.2	4	8.7
		Test #: G1-1804-707-55				Test #: G1-1804-707-71					Test #: G1-1804-707-71				

PHOTOMETRICS - DIRECTIONALS (CONTINUED)

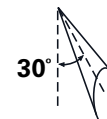
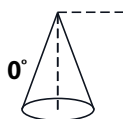

Trims	Lamp	0° Aiming Angle Horizontal Footcandles				30° Aiming Angle Horizontal Footcandles					30° Aiming Angle Vertical Footcandles				
		MH	FC	L	W	MH	FC	L	W	CB	MH	FC	L	W	CB
1485MWWB	7MR16 EXPERTCOLOR S10 930 D 10/1 Lumens: 481lm Beam Angle: 9.8° CBCP: 6258cd	6'	166.3	1	1	6'	87.9	1.3	1	3.5	2'	191.5	1.2	0.6	3.5
		8'	93.5	1.4	1.4	8'	49.5	1.9	1.4	4.6	3'	85.1	1.9	0.8	5.2
		10'	59.9	1.6	1.6	10'	31.7	2.4	1.8	5.8	4'	47.9	2.6	1.2	6.9
		12.5'	38.3	2.2	2.2	12.5'	20.3	3	2.4	7.2	5'	30.6	3.1	1.4	8.7
		Test #: G1-1804-707-9				Test #: G1-1804-707-20					Test #: G1-1804-707-20				
	7MR16 EXPERTCOLOR F25 930 D 10/1 Lumens: 497lm Beam Angle: 20.8° CBCP: 2526cd	6'	66.8	2	2	6'	45.6	2.5	2.2	3.5	2'	92.7	2	1.2	3.5
		8'	37.6	2.6	2.8	8'	25.6	3.3	3	4.6	3'	41.2	2.9	1.8	5.2
		10'	24	3.4	3.4	10'	16.4	4.2	3.8	5.8	4'	23.2	4	2.4	6.9
		12.5'	15.4	4.2	4.2	12.5'	10.5	5.3	4.8	7.2	5'	14.8	5	3	8.7
		Test #: G1-1804-707-33				Test #: G1-1804-707-4					Test #: G1-1804-707-45				
	7MR16 EXPERTCOLOR F35 930 D 10/1 Lumens: 487lm Beam Angle: 30.6° CBCP: 1457cd	6'	38.9	3	3	6'	27.4	3.4	3.4	3.5	2'	61.5	1.9	1.6	3.5
		8'	21.9	4	4	8'	15.4	4.6	4.6	4.6	3'	27.3	3	2.6	5.2
		10'	14	5	5	10'	9.9	5.7	5.6	5.8	4'	15.4	4	3.4	6.9
		12.5'	9	6.2	6.4	12.5'	6.3	7.2	7.2	7.2	5'	9.8	5.1	4.2	8.7
		Test #: G1-1804-707-56				Test #: G1-1804-707-72					Test #: G1-1804-707-72				
1443MWWF	7MR16 EXPERTCOLOR S10 930 D 10/1 Lumens: 481lm Beam Angle: 9.8° CBCP: 6258cd	6'	25.1	2.8	2.8	6'	12.4	3.7	3.2	3.5	2'	30.1	2.5	1.6	3.5
		8'	14.1	3.6	3.6	8'	7	5	4.4	4.6	3'	13.4	3.9	2.4	5.2
		10'	9	4.6	4.6	10'	4.5	6.4	5.4	5.8	4'	7.5	5.2	3.2	6.9
		12.5'	5.8	5.8	5.8	12.5'	2.9	7.9	6.8	7.2	5'	4.8	6.6	4	8.7
		G1-1804-707-3				Test #: G1-1804-707-14					Test #: G1-1804-707-14				
	7MR16 EXPERTCOLOR F25 930 D 10/1 Lumens: 497lm Beam Angle: 20.8° CBCP: 2526cd	6'	19.8	3.2	3.2	6'	10.5	4	3.8	3.5	2'	27.5	2.4	1.8	3.5
		8'	11.1	4.2	4.2	8'	5.9	5.4	5	4.6	3'	12.2	3.7	2.6	5.2
		10'	7.1	5.4	5.4	10'	3.8	6.7	6.2	5.8	4'	6.9	5	3.6	6.9
		12.5'	4.6	6.8	6.8	12.5'	2.4	8.5	7.6	7.2	5'	4.4	6.2	4.4	8.7
		Test #: G1-1804-707-26				Test #: G1-1804-707-39					Test #: G1-1804-707-39				
	7MR16 EXPERTCOLOR F35 930 D 10/1 Lumens: 487lm Beam Angle: 30.6° CBCP: 1457cd	6'	15.8	3.6	3.6	6'	8.6	4.4	4.2	3.5	2'	25.1	2.3	1.8	3.5
		8'	8.9	5	5	8'	4.9	5.8	5.6	4.6	3'	11.2	3.6	2.8	5.2
		10'	5.7	6.2	6.2	10'	3.1	7.3	7	5.8	4'	6.3	4.8	3.8	6.9
		12.5'	3.6	7.8	7.8	12.5'	2	9.3	8.8	7.2	5'	4	6.1	4.8	8.7
		Test #: G1-1804-707-50				Test #: G1-1804-707-61					Test #: G1-1804-707-61				

PHOTOMETRICS - DIRECTIONALS (CONTINUED)

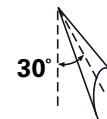
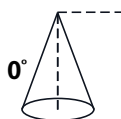

Trims	Lamp	0° Aiming Angle Horizontal Footcandles				30° Aiming Angle Horizontal Footcandles					30° Aiming Angle Vertical Footcandles				
		MH	FC	L	W	MH	FC	L	W	CB	MH	FC	L	W	CB
1447MWVB	7MR16 EXPERTCOLOR S10 930 D 10/1 Lumens: 481lm Beam Angle: 9.8° CBCP: 6258cd	6'	95.2	1.4	1.4	6'	54.5	1.9	1.6	3.5	2'	105.8	1.9	0.8	3.5
		8'	53.5	1.8	1.8	8'	30.7	2.6	2	4.6	3'	47	2.9	1.4	5.2
		10'	34.3	2.4	2.4	10'	19.6	3.2	2.6	5.8	4'	26.5	3.9	1.8	6.9
		12.5'	21.9	3	3	12.5'	12.6	4	3.4	7.2	5'	16.9	4.8	2.2	8.7
		Test #: G1-1804-707-6				Test #: G1-1804-707-17					Test #: G1-1804-707-17				
	7MR16 EXPERTCOLOR F25 930 D 10/1 Lumens: 497lm Beam Angle: 20.8° CBCP: 2526cd	6'	51.4	2.2	2.2	6'	32.2	2.8	2.6	3.5	2'	70.7	2.1	1.2	3.5
		8'	28.9	3	3	8'	18.1	3.7	3.4	4.6	3'	31.4	3.2	2	5.2
		10'	18.5	3.8	3.8	10'	11.6	4.7	4.4	5.8	4'	17.7	4.3	2.6	6.9
		12.5'	11.8	4.6	4.6	12.5'	7.4	5.8	5.6	7.2	5'	11.3	5.4	3.4	8.7
		Test #: G1-1804-707-30				Test #: G1-1804-707-42					Test #: G1-1804-707-42				
	7MR16 EXPERTCOLOR F35 930 D 10/1 Lumens: 487lm Beam Angle: 30.6° CBCP: 1457cd	6'	32.6	3	3	6'	22.1	3.6	3.4	3.5	2'	54.4	2	1.6	3.5
		8'	18.3	4	4	8'	12.4	4.7	4.6	4.6	3'	24.2	3.1	2.4	5.2
		10'	11.7	5	5	10'	8	5.9	5.8	5.8	4'	13.6	4.2	3.2	6.9
		12.5'	7.5	6.4	6.4	12.5'	5.1	7.5	7.2	7.2	5'	8.7	5.3	4.2	8.7
		Test #: G1-1804-707-53				Test #: G1-1804-707-64					Test #: G1-1804-707-64				
1487MWVB	7MR16 EXPERTCOLOR S10 930 D 10/1 Lumens: 481lm Beam Angle: 9.8° CBCP: 6258cd	6'	95.6	1.4	1.4	6'	54.4	1.8	1.8	3.5	2'	94.1	1.8	1	3.5
		8'	53.8	1.8	2	8'	30.6	2.4	2.4	4.6	3'	41.8	2.8	1.6	5.2
		10'	34.4	2.2	2.6	10'	19.6	3	3	5.8	4'	23.5	3.8	2	6.9
		12.5'	22	2.8	3.2	12.5'	12.5	3.9	3.8	7.2	5'	15.1	4.7	2.6	8.7
		Test #: G1-1804-707-10				Test #: G1-1804-707-21					Test #: G1-1804-707-21				
	7MR16 EXPERTCOLOR F25 930 D 10/1 Lumens: 497lm Beam Angle: 20.8° CBCP: 2526cd	6'	53.9	2.2	2.2	6'	32.2	2.6	2.6	3.5	2'	76.3	1.9	1.4	3.5
		8'	30.3	2.8	3	8'	18.1	3.6	3.6	4.6	3'	33.9	2.9	2	5.2
		10'	19.4	3.6	3.8	10'	11.6	4.5	4.4	5.8	4'	19.1	3.9	2.8	6.9
		12.5'	12.4	4.6	4.8	12.5'	7.4	5.7	5.6	7.2	5'	12.2	4.8	3.4	8.7
		Test #: G1-1804-707-35				Test #: G1-1804-707-46					Test #: G1-1804-707-46				
	7MR16 EXPERTCOLOR F35 930 D 10/1 Lumens: 487lm Beam Angle: 30.6° CBCP: 1457cd	6'	32.6	3	3	6'	21.1	3.5	3.4	3.5	2'	51.9	2	1.6	3.5
		8'	18.3	4	4	8'	11.9	4.6	4.6	4.6	3'	23.1	3.2	2.4	5.2
		10'	11.7	5	5	10'	7.6	5.7	5.8	5.8	4'	13	4.2	3.4	6.9
		12.5'	7.5	6.4	6.2	12.5'	4.9	7.3	7.2	7.2	5'	8.3	5.3	4.2	8.7
		Test #: G1-1804-707-57				Test #: G1-1804-707-73					Test #: G1-1804-707-73				

PHOTOMETRICS - DIRECTIONALS (CONTINUED)

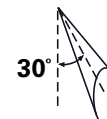
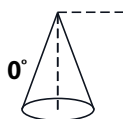

Trims	Lamp	0° Aiming Angle Horizontal Footcandles				30° Aiming Angle Horizontal Footcandles					30° Aiming Angle Vertical Footcandles					
		MH	FC	L	W	MH	FC	L	W	CB	MH	FC	L	W	CB	
1449 AAG	7MR16 EXPERTCOLOR S10 930 D 10/1 Lumens: 481lm Beam Angle: 9.8° CBCP: 6258cd	6'	58.3	1.6	1.6	6'	34.6	2.2	1.8	3.5	2'	61.9	2.1	1	3.5	
		8'	32.8	2.2	2.2	8'	19.5	3.1	2.6	4.6	3'	27.5	3.2	1.6	5.2	
		10'	21	2.6	2.6	10'	12.5	3.9	3.2	5.8	4'	15.5	4.3	2.2	6.9	
		12.5'	13.4	3.4	3.4	12.5'	8	4.9	4	7.2	5'	9.9	5.4	2.8	8.7	
			Test #: G1-1804-707-7				Test #: G1-1804-707-18					Test #: G1-1804-707-18				
	7MR16 EXPERTCOLOR F25 930 D 10/1 Lumens: 497lm Beam Angle: 20.8° CBCP: 2526cd	6'	36.6	2.4	2.4	6'	22.2	3.2	3	3.5	2'	54.2	2.1	1.4	3.5	
		8'	20.6	3.2	3.2	8'	12.5	4.3	4	4.6	3'	24.1	3.3	2	5.2	
		10'	13.2	4	4	10'	8	5.5	5	5.8	4'	13.5	4.4	2.8	6.9	
		12.5'	8.4	5.2	5.2	12.5'	5.1	6.8	6.2	7.2	5'	8.7	5.6	3.4	8.7	
			Test #: G1-1804-707-31				Test #: G1-1804-707-43					Test #: G1-1804-707-43				
	7MR16 EXPERTCOLOR F35 930 D 10/1 Lumens: 487lm Beam Angle: 30.6° CBCP: 1457cd	6'	25.7	3	3	6'	17	3.8	3.6	3.5	2'	42.2	2.3	1.6	3.5	
		8'	14.4	4.2	4.2	8'	9.6	5.1	4.8	4.6	3'	18.7	3.5	2.4	5.2	
10'		9.2	5.2	5.2	10'	6.1	6.3	6	5.8	4'	10.5	4.6	3.4	6.9		
12.5'		5.9	6.6	6.6	12.5'	3.9	8	7.4	7.2	5'	6.7	5.9	4.2	8.7		
		Test #: G1-1804-707-54				Test #: G1-1804-707-65					Test #: G1-1804-707-65					
1489 AAG	7MR16 EXPERTCOLOR S10 930 D 10/1 Lumens: 481lm Beam Angle: 9.8° CBCP: 6258cd	6'	48.1	1.8	1.8	6'	24.7	2.8	2.2	3.5	2'	50.1	2.1	1.2	3.5	
		8'	27.1	2.4	2.4	8'	13.9	3.7	3	4.6	3'	22.2	3.3	1.8	5.2	
		10'	17.3	3.2	3	10'	8.9	4.7	3.8	5.8	4'	12.5	4.3	2.4	6.9	
		12.5'	11.1	4	3.8	12.5'	5.7	5.9	4.8	7.2	5'	8	5.5	3	8.7	
			Test #: G1-1804-707-11				Test #: G1-1804-707-22					Test #: G1-1804-707-22				
	7MR16 EXPERTCOLOR F25 930 D 10/1 Lumens: 497lm Beam Angle: 20.8° CBCP: 2526cd	6'	33.9	2.6	2.4	6'	19.1	3.3	3	3.5	2'	45.4	2.2	1.4	3.5	
		8'	19	3.4	3.4	8'	10.8	4.4	4	4.6	3'	20.2	3.3	2.2	5.2	
		10'	12.2	4.2	4.2	10'	6.9	5.5	5	5.8	4'	11.3	4.5	2.8	6.9	
		12.5'	7.8	5.4	5.2	12.5'	4.4	6.9	6.4	7.2	5'	7.3	5.6	3.6	8.7	
			Test #: G1-1804-707-36				Test #: G1-1804-707-47					Test #: G1-1804-707-47				
	7MR16 EXPERTCOLOR F35 930 D 10/1 Lumens: 487lm Beam Angle: 30.6° CBCP: 1457cd	6'	24.3	3.2	3.2	6'	14.8	3.6	3.6	3.5	2'	35.1	2.3	1.6	3.5	
		8'	13.7	4.2	4.2	8'	8.4	4.8	4.8	4.6	3'	15.6	3.4	2.6	5.2	
10'		8.8	5.2	5.2	10'	5.3	6	6	5.8	4'	8.8	4.7	3.4	6.9		
12.5'		5.6	6.6	6.6	12.5'	3.4	7.5	7.4	7.2	5'	5.6	5.9	4.4	8.7		
		Test #: G1-1804-707-58				Test #: G1-1804-707-69					Test #: G1-1804-707-69					

PHOTOMETRICS - WALL WASH

Notes and Formulas

- Illuminance values for multiple fixtures are based upon the center two units of a four unit array. Footcandle values are centerline of fixtures and centered between fixtures.
- Illuminance values are cosine corrected initial values with no contribution from inter reflections from other room surfaces. Total illumination may increase from contributions from other surfaces.
- DD=Distance Down from Ceiling.
- Changing fixture spacing will affect illuminance level.

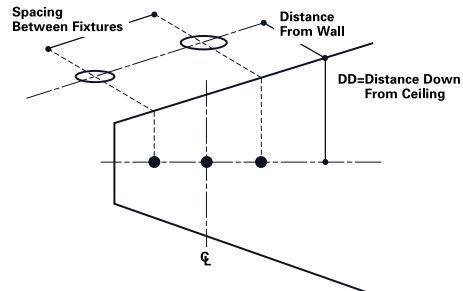

$$\text{New Fc} = \frac{\text{Existing Spacing}}{\text{New Spacing}} \times \text{Average Table Fc Level}$$

For optimal wall washing, space fixtures equal to the distance from the wall.

Single Footcandles
3' from wall (distance from fixture along wall)

Trims	Lamp	DD	•	1'	2'	3'	4'	5'	6'
1442MWWF	7MR16 EXPERTCOLOR F25 930 D 10/1 Lumens: 497lm Beam Angle: 20.8° CBCP: 2526cd	1'	•	1.3	0.9	0.4	0.1	0.1	0
		2'	•	3.3	2.7	1.5	0.7	0.3	0.1
		3'	•	3.4	2.8	1.7	1	0.5	0.3
		4'	•	3	2.6	1.7	1	0.6	0.3
		5'	•	2.5	2.2	1.5	0.9	0.5	0.3
		6'	•	1.9	1.7	1.3	0.8	0.5	0.3
		7'	•	1.5	1.3	1	0.7	0.5	0.3
		8'	•	1.1	1	0.8	0.6	0.4	0.3
		9'	•	0.8	0.8	0.7	0.5	0.4	0.3
		10'	•	0.6	0.6	0.5	0.4	0.3	0.2

Test #: G1-1804-707-25

Multiple Unit Footcandles
2' from wall (spacing between fixtures)

•	- 2'-	•	•	- 3'-	•
3.4	3.6	3.4	3	2.2	3
6.8	7.4	6.8	5.7	5.5	5.7
6.6	7.2	6.6	5.6	5.5	5.6
5.6	6.1	5.6	4.8	4.8	4.8
4.3	4.8	4.3	3.7	3.9	3.7
3.3	3.5	3.3	2.8	3	2.8
2.4	2.6	2.4	2.1	2.3	2.1
1.8	1.9	1.8	1.6	1.7	1.6
1.3	1.4	1.3	1.2	1.3	1.2
1	1.1	1	0.9	1	0.9

Test #: G1-1804-707-25

3' from wall (spacing between fixtures)

•	- 2'-	•	•	- 3'-	•
1.6	1.8	1.6	1.4	1.3	1.4
4.8	5.4	4.8	4.1	4.2	4.1
5.1	5.6	5.1	4.4	4.5	4.4
4.7	5.1	4.7	4	4.2	4
4	4.3	4	3.4	3.7	3.4
3.2	3.5	3.2	2.8	3	2.8
2.5	2.7	2.5	2.2	2.4	2.2
1.9	2.1	1.9	1.7	1.9	1.7
1.5	1.6	1.5	1.3	1.5	1.3
1.2	1.2	1.2	1.1	1.1	1.1

Test #: G1-1804-707-25

PHOTOMETRICS - WALL WASH (CONTINUED)

Trims	Lamp	Single Footcandles 3' from wall (distance from fixture along wall)									
		DD	•	1'	2'	3'	4'	5'	6'		
1446MWVB	7MR16 EXPERTCOLOR F25 930 D 10/1 Lumens: 497lm Beam Angle: 20.8° CBCP: 2526cd	1	0.7	0.3	0.1	0.1	0	0	0		
		3.8	2.7	1.3	0.5	0.2	0.1	0	0.1		
		5.9	4.3	2	0.9	0.4	0.2	0.1	0.2		
		6.7	5.1	2.5	1.1	0.5	0.2	0.1	0.2		
		6.1	4.8	2.7	1.2	0.6	0.3	0.2	0.2		
		4.9	4.1	2.5	1.3	0.6	0.3	0.2	0.2		
		3.7	3.2	2.1	1.2	0.6	0.3	0.2	0.2		
		2.8	2.4	1.7	1.1	0.6	0.3	0.2	0.2		
		2	1.8	1.4	0.9	0.6	0.3	0.2	0.2		
		1.5	1.4	1.1	0.8	0.5	0.3	0.2	0.2		
		Test #: G1-1804-707-29									

Multiple Unit Footcandles 2' from wall (spacing between fixtures)						3' from wall (spacing between fixtures)					
•	- 2'-	•	•	- 3'-	•	•	- 2'-	•	•	- 3'-	•
2.7	2.9	2.7	2.4	1.7	2.4	1.3	1.5	1.3	1.1	1.1	1.1
8.4	8.7	8.4	7.4	5.5	7.4	5	5.4	5	4.3	3.8	4.3
11.9	12.4	11.9	10.3	8.1	10.3	7.9	8.6	7.9	6.7	6.1	6.7
11.9	12.9	11.9	10.2	8.8	10.2	9.2	10.1	9.2	7.8	7.4	7.8
9.8	10.8	9.8	8.3	7.9	8.3	8.7	9.7	8.7	7.3	7.4	7.3
7.4	8.2	7.4	6.2	6.4	6.2	7.4	8.1	7.4	6.2	6.5	6.2
5.4	5.9	5.4	4.6	4.9	4.6	5.8	6.4	5.8	4.9	5.3	4.9
4	4.3	4	3.4	3.7	3.4	4.5	4.9	4.5	3.8	4.2	3.8
2.9	3.1	2.9	2.5	2.7	2.5	3.4	3.7	3.4	2.9	3.2	2.9
2.2	2.3	2.2	0.9	1	0.9	2.6	2.8	2.6	2.3	2.5	2.3
Test #: G1-1804-707-29						Test #: G1-1804-707-29					

Trims	Lamp	Single Footcandles 3' from wall (distance from fixture along wall)									
		DD	•	1'	2'	3'	4'	5'	6'		
1486MWVB	7MR16 EXPERTCOLOR F25 930 D 10/1 Lumens: 497lm Beam Angle: 20.8° CBCP: 2526cd	0.8	0.7	0.3	0.1	0.1	0	0	0		
		3.7	2.6	1.2	0.5	0.2	0.1	0	0.1		
		6.4	4.5	2	0.8	0.3	0.2	0.1	0.2		
		7.7	5.5	2.6	1	0.4	0.2	0.1	0.2		
		7	5.3	2.7	1.2	0.5	0.3	0.1	0.2		
		5.7	4.5	2.5	1.2	0.6	0.3	0.2	0.2		
		4.3	3.6	2.2	1.2	0.6	0.3	0.2	0.2		
		3.2	2.7	1.8	1	0.6	0.3	0.2	0.2		
		2.3	2.1	1.5	0.9	0.5	0.3	0.2	0.2		
		1.7	1.6	1.2	0.8	0.5	0.3	0.2	0.2		
		Test #: G1-1804-707-34									

Multiple Unit Footcandles 2' from wall (spacing between fixtures)						3' from wall (spacing between fixtures)					
•	- 2'-	•	•	- 3'-	•	•	- 2'-	•	•	- 3'-	•
2.2	2.5	2.2	1.9	1.7	1.9	1.1	1.3	1.1	0.9	1	0.9
8.6	8.6	8.6	7.6	5.3	7.6	4.9	5.3	4.9	4.2	3.7	4.2
13.1	13.3	13.1	11.5	8.2	11.5	8.4	9.1	8.4	7.2	6.2	7.2
13.3	13.9	13.3	11.5	9.1	11.5	10.2	11	10.2	8.7	7.7	8.7
11	11.9	11	9.3	8.4	9.3	9.7	10.6	9.7	8.2	7.9	8.2
8.3	9.1	8.3	7	6.8	7	8.2	9.1	8.2	6.9	7	6.9
6	6.6	6	5.1	5.3	5.1	6.5	7.1	6.5	5.5	5.8	5.5
4.4	4.8	4.4	3.7	4	3.7	5	5.5	5	4.2	4.6	4.2
3.2	3.5	3.2	2.7	3	2.7	3.8	4.1	3.8	3.2	3.6	3.2
2.4	2.5	2.4	2	2.2	2	2.9	3.1	2.9	2.5	2.7	2.5
Test #: G1-1804-707-34						Test #: G1-1804-707-34					

