

|           |  |      |  |             |  |
|-----------|--|------|--|-------------|--|
| Catalog # |  | Date |  | Prepared by |  |
| Project   |  | Type |  | Notes       |  |

# HALO™

OUTDOOR LIGHTING



## ALP PREMIUM AREA LIGHT

WITH CCT SELECT AND LUMEN SELECT



LED DUSK TO DAWN AREA LIGHT | 60W 9000LM | 120-277V INPUT | GRAY HOUSING | DROP LENS WITH ADJUSTABLE BRIGHTNESS & CCT SELECT TECHNOLOGY

The ALP Premium LED Area Light delivers a versatile security lighting solution with many configuration possibilities by integrating three brightness settings and three selectable CCT color temperatures.

### TOP PRODUCT FEATURES

Selectable up to **9000 LUMENS**

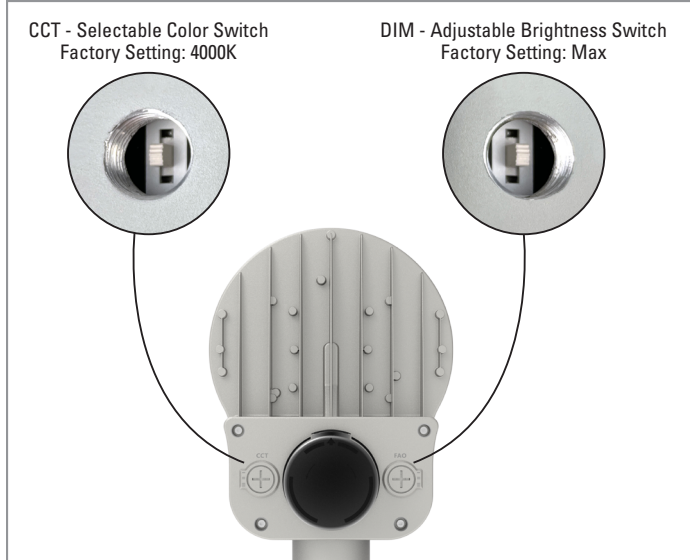

- 3 Adjustable LED brightness settings (9000 Lumens, 6000 Lumens, 4000 Lumens)
- 3 Selectable light color temperatures (3000K, 4000K, & 5000K)
- NEMA 3-Pin replaceable photocell for Dusk to Dawn operation (Photocell Included)
- Constructed of rugged die cast aluminum housing in textured Gray finish
- 50,000 hours of rated life
- UV resistant prismatic PC lens with Type V distribution
- IP65 rated sealed against dust and water
- Universal power supply 120-277V, with 0-10V Dimmability down to 10%
- 5-year warranty



### INTERACTIVE MENU

- [Order Information](#) page 2
- [Product Specification](#) page 3
- [Product Warranty](#) page 3
- [Product Dimensions](#) page 2
- [Photometric Data](#) page 3

### PRODUCT CERTIFICATION



\*DLC listing will be completed within Q1-2023

### TYPICAL APPLICATIONS



#### COMMERCIAL & RESIDENTIAL OUTDOOR

- Backyards
- Barns
- Farms
- Parking lots
- Garages
- Alleyways
- Perimeter lighting among other security applications

### MOUNTING TYPES

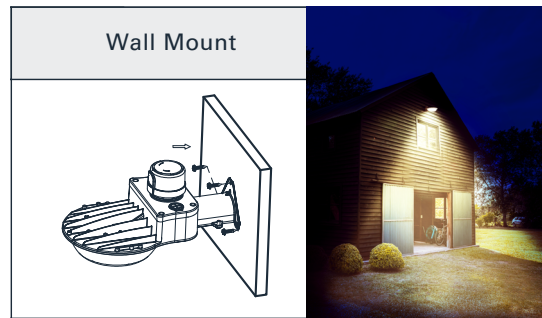
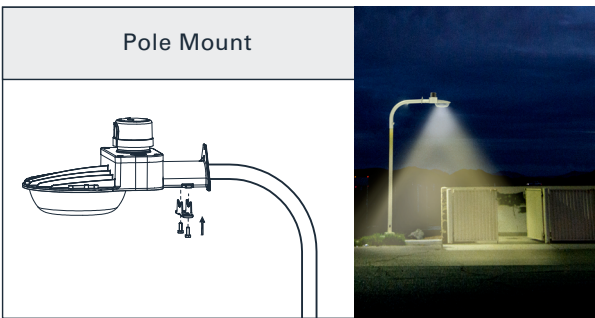

### ORDER INFORMATION

| Catalog Number  | Description                                      | Material no. | UPC          | Case Qty | Case Dimensions (in.) |       |      | Weight (lbs) |
|-----------------|--|--------------|--------------|----------|-----------------------|-------|------|--------------|
|                 |  |              |              |          | L                     | W     | H    |              |
| ALP90LSFSUNVDGY | BRN LGHT, DCST 60W 9K LMN SEL, 3CCT, D2D, UNV GY | 13605834     | 080083260843 | 2        | 19.88                 | 16.65 | 7.28 | 13.45        |

### ACCESSORIES (SOLD SEPARATELY)



| Catalog Number | Description        |
|----------------|--------------------|
| EA24           | 24 in CURVED MOUNT |



| Catalog Number | Description                      |
|----------------|----------------------------------|
| SL3120         | Replacement TWIST LOCK PHOTOCELL |

### PRODUCT DIMENSIONS

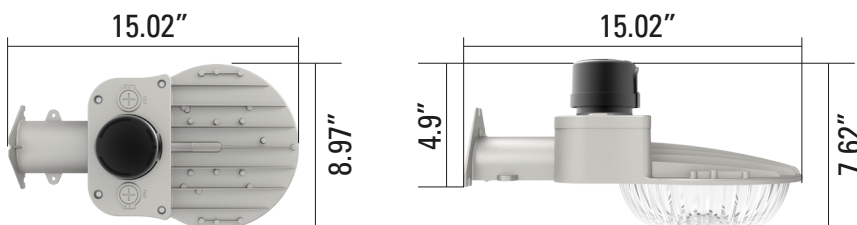

### PRODUCT SPECIFICATIONS

#### Construction

- Durable die-cast aluminum housing suitable for wet locations
- Glare free UV & impact resistant PC prismatic drop lens
- Lens is fully sealed to keep out insects and bugs
- Type 5 NEMA distribution
- Rust-resistant powder coated gray finish
- Suitable for wall or pole mount
- 1.5G vibration rated per ANSI C136.31

#### Integrated Controls

- Dusk to Dawn (Nighttime on / Daytime off) via NEMA 3-Pin photocell sensor

#### Mounting

- Easily mounts to a wooden post, pole or wall using 2" lag screws.
- Can be mounted to a 1-1/4" pipe (1-5/8" Outer Diameter)- pipe not included

#### Electrical

- 3 Adjustable LED power output settings (DIM field adjustable output)
- 3 Selectable light color temperature settings – 3000K / 4000K / 5000K
- Maintenance-free LEDs with estimated 50,000 hours lifespan based on LM-80 results and TM-21 calculations.
- Fixture operating temperature range from -40°C to 40°C
- Electrical operating voltage 120-277V, 50/60Hz
- THD ≤ 20%; Power factor ≥ 90% @60W
- 0-10V Dimmable down to 10%. Additional 0-10V wires are required. Does not work with standard household dimmers.

#### Compliance

- UL certified for USA and Canada for wet locations
- Contains no mercury or lead - RoHS compliant (RoHS 2.0)
- DLC 5.1 Premium Listed
- IP65 Rated and sealed against dust and water perfect for demanding outdoor applications

#### Finish

- Rust-resistant powder coated gray finish

#### Warranty

- Five year limited warranty, consult website for details. [www.cooperlighting.com](http://www.cooperlighting.com)

### PHOTOMETRIC DATA

| Catalog Number  | Power | CCT   | Lumens | Efficacy | Voltage  | Dimming | CRI | Lifespan   | Photocell                            | Equivalent |
|-----------------|-------|-------|--------|----------|----------|---------|-----|------------|--------------------------------------|------------|
| ALP90LSFSUNVDGY | 28W   | 3000K | 4446   | 155      | 120-277V | 0-10V   | >70 | 50,000 Hrs | 3-Pin NEMA Replaceable Photo control | 250W       |
|                 |       | 4000K | 4751   | 170      |          |         |     |            |                                      |            |
|                 |       | 5000K | 4829   | 168      |          |         |     |            |                                      |            |
|                 | 40W   | 3000K | 5853   | 146      |          |         |     |            |                                      |            |
|                 |       | 4000K | 6427   | 164      |          |         |     |            |                                      |            |
|                 |       | 5000K | 6417   | 157      |          |         |     |            |                                      |            |
|                 | 60W   | 3000K | 8212   | 134      |          |         |     |            |                                      |            |
|                 |       | 4000K | 9284   | 156      |          |         |     |            |                                      |            |
|                 |       | 5000K | 9065   | 145      |          |         |     |            |                                      |            |

### ELECTRICAL DATA

| Catalog Number  | Power | 120V | 208V  | 240V  | 277V  |
|-----------------|-------|------|-------|-------|-------|
| ALP90LSFSUNVDGY | 60W   | 0.5A | 0.29A | 0.25A | 0.22A |

### SUGGESTED MOUNTING HEIGHT

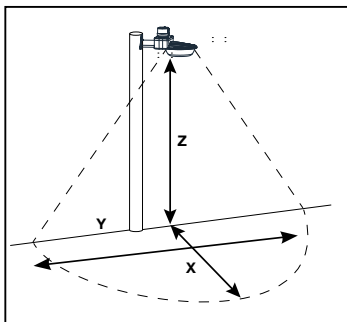

| Minimum Footcandles (FC) |        | 0.50 FC |    |     |    |     |    |     |    |
|--------------------------|--------|---------|----|-----|----|-----|----|-----|----|
| Mounting Height (Z)      |        | 8'      |    | 10' |    | 15' |    | 20' |    |
| Catalog Number           | Lumens | X       | Y  | X   | Y  | X   | Y  | X   | Y  |
| ALP90LSFSUNVDGY          | 4751   | 21      | 41 | 23  | 45 | 25  | 50 | /   | /  |
|                          | 6427   | 23      | 45 | 25  | 50 | 28  | 56 | 31  | 59 |
|                          | 9284   | 26      | 49 | 29  | 55 | 33  | 64 | 35  | 69 |

X = Forward Throw  
Y = Wall Spread  
Z = Mounting Heights

Notes:  
Forward throw X = 1/2 Y for wall-mount applications only  
See IES files for detailed photometry