

Project		Catalog #		Type	
Prepared by		Notes		Date	

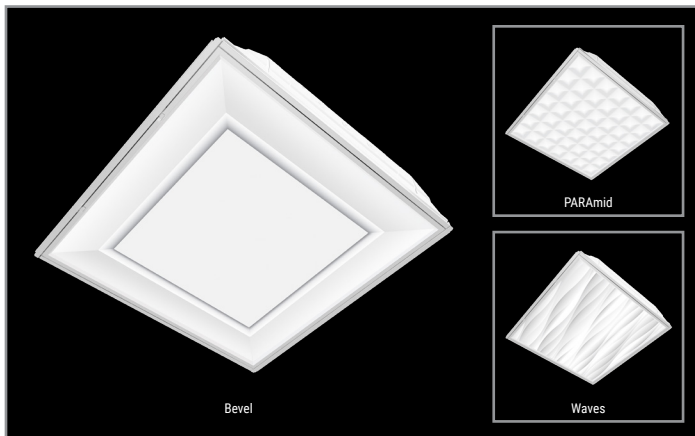

Corelite

Perceive™ 22PD

2' x 2' Recessed LED Specification Series

Typical Applications

Office • Education • Healthcare • Hospitality • Retail

Product Certification



Product Features



Interactive Menu

- Order Information page 2
- Photometric Data page 3
- Connected Systems page 6
- Product Warranty

Top Product Features

- Proprietary optical system based on human perception of depth
- Multiple dynamic 3D optical patterns
- Glare-reducing performance provides comfortable high-quality illumination
- Available in 2x2, 2x4, and 1x4 sizes
- Thoughtfully designed wireless control options
- Options to meet Trade Agreements Act requirements

Options

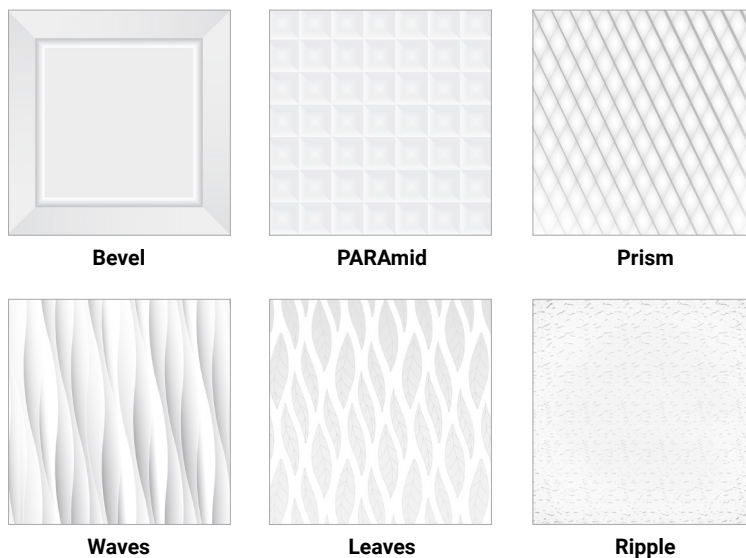

[additional product diagrams](#)

Order Information

SAMPLE ORDER NUMBER: 22PD-40-PB1-L835-U

Domestic Preferences	Rating	Series	Lumen Output	Shielding	Voltage	Options	Emergency Options
Domestic Preferences ⁽¹⁴⁾	Rating	Series	Lumen Output ⁽¹⁾	Shielding	Voltage	Options	Emergency Options
[Blank] =Standard TAA =Trade Agreements Act	[Blank] =Standard ATW-SW4 =Chicago Rated	22PD =2x2 Perceive, Service From Below	20 =2000 Lumens 25 =2500 Lumens 30 =3000 Lumens 35 =3500 Lumens 40 =4000 Lumens 45 =4500 Lumens 50 =5000 Lumens 55 =5500 Lumens 60 =6000 Lumens 70 =7000 Lumens ⁽²⁾ 80 =8000 Lumens ⁽²⁾	PB1 =Bevel PC3 =PARAMid PP3 =Prism PW1 =Waves PL1 =Leaves PR1 =Ripple	[Blank] =Universal Voltage 120-277 347V =347 Volt ⁽⁴⁾ 48V =48 Volt Low-voltage (Class 2) ⁽²⁾	GL =Single Element Fuse GM =Double Element Fuse	[Blank] =No emergency EL7W =7-watt 120V-277V emergency battery pack ⁽⁵⁾ EL10W =10-watt 120V-277V emergency battery pack ⁽⁵⁾ EL14W =14-watt 120V-277V emergency battery pack ⁽⁵⁾ EL10WSD =10W emergency battery pack with self-diagnostic installed ^{(5),(7)} EL14WSD =14W emergency battery pack with self-diagnostic installed ^{(5),(7)} ELV7W =Low-voltage system, 7-watt emergency battery pack ^{(5),(C)} ELV14W =Low-voltage system, 14-watt emergency battery pack ^{(5),(C)} ETRD =Emergency Transfer Relay with dimming control ⁽⁶⁾ RRU =LVS Controls Emergency Transfer Relay with dimming control ⁽⁶⁾
Notes ⁽¹⁴⁾ Only product configurations with this designated prefix are built to be compliant with the Trade Agreements Act of 1979 (TAA). Please refer to DOMESTIC PREFERENCES website for more information. Components shipped separately may be separately analyzed under domestic preference requirements.			Notes ⁽¹⁾ Custom lumen output available: 2000 to 8500 lumens. ⁽²⁾ 5LTHD driver not available on 70, and 80 lumen outputs.		Notes ⁽⁴⁾ 347 with emergency not available with SD driver. ^(C) Consult WaveLinX Low-Voltage or DLVP system pages for additional details and compatibility.		Notes ⁽⁵⁾ Factory installed with integral test switch/indicator/laser test. For approximate delivered lumens multiply the lumens per watt of the desired fixture by the wattage of the emergency battery pack (100 lm/W x 7=700 lumens). IES-format photometry for luminaire under emergency operation available. Battery option increases total height by 1 inch. ⁽⁶⁾ Used to bypass local control during outage. Must be used in conjunction with UL 1008 device (provided by others). Devices are universal voltage (120-277V). 347 not available. ⁽⁷⁾ EL10WSD and EL14WSD not available with 347V. ^(C) Consult WaveLinX Low-Voltage or DLVP system pages for additional details and compatibility.

CRI/CCT	Flex	Driver Type	Number of Drivers
CRI/CCT ⁽⁸⁾	Flex ⁽⁹⁾	Driver Type	Number of Drivers
L830 =80CRI, 3000K L835 =80CRI, 3500K L840 =80CRI, 4000K L850 =80CRI, 5000K L930 =90CRI, 3000K L935 =90CRI, 3500K L940 =90CRI, 4000K L950 =90CRI, 5000K	[Blank] =No Flex A3/8-4/18GDIM =3/8" Flex with 0-10V Dimming Leads A3/8-2/18G =3/8" Flex with line and common A3/8-5/18GDIM =Flex with 0-10V Dimming leads and Blue for alternate wiring. See below for details.	[Blank] =0-10V Dimming Driver (1%-100% Dimming) 5LTD =DALI Driver (5%-100% Dimming) 5LTHD =DALI Driver (1%-100% Dimming) LV =Low-voltage System Driver (0%-100% Dimming) ^(C) SD =Step Dimming Driver (50%, 100% Dimming) LH =Lutron HiLume (LDE1 series) 1%-100% EcoSystem Driver with Soft-on Fade to Black dimming ^(F) SR =Sensor-ready Driver (1%-100% Dimming)	[Blank] =1 Driver
Notes ⁽⁸⁾ 90CRI - 2700K available - consult factory.	Flexible Metal Conduit Options ⁽⁹⁾ Multiple options available in online configurator. See additional notes on Flex below. Flex options available for 0-10V dimming control, DALI dimming control, emergency and night light functions. 72-inch factory-installed and pre-wired to driver, fitted to luminaire housing access plate with 90° enclosed FMC connector. Not all options may be combined and installation ratings vary by type. A3/8-***** series notes: Factory installed dimming option 3/8" flexible metal conduit with 2-#18 power and ground wires and 2-#18 UL-listed jacketed 0-10V +/- control wires. Meets UL 66, 83, 1479, 1569, 1581, 2556. NEC® 250.118, 300.22(C), 392, 396, 330, 501, 502, 503, 530, 504, 505, 518, 520, 530, 645, 72; Federal Specification A-A-59544 (formerly J-C-308B); all applicable OSHA and HUD Requirements. UL Classified 1-, 2-, and 3-hour through penetration with applicable fire stop product (not included). May be surface mounted, fished and/or embedded in plaster. Cable tray and approved raceway rated, install per NEC®; Environmental Air-Handling Space Installation per NEC® 300.22(C).	Notes Integrated options must be used in conjunction with the associated system and may not be compatible with other options or accessories. Please refer to the following: ^(C) Consult WaveLinX Low-Voltage or DLVP system pages for additional details and compatibility. ^(F) Consult Marketplace Options - Lutron system pages for additional details and compatibility. Compatible only with driver series shown. Requires field commissioning to operate or dim. Contact Lutron at www.lutron.com	

Integrated Sensing Systems	Packaging	Accessories
Integrated Sensing Systems	Packaging	Accessories (order separately) ⁽¹⁵⁾
[Blank] =No Sensor WAA =WaveLinX PRO Wireless Integrated Sensor ^{(10),(A)} WPN =WaveLinX PRO Wireless Node without Sensor ^{(10),(A)} WAB =WaveLinX LITE Wireless Integrated Sensor ^{(11),(B)} WLA =Low-voltage Integrated Sensor ^{(12),(C)} SVPD1 =0-10V Stand-alone Integrated Sensor ^{(11),(D)}	U =Unit Pack PAL =Job Pack, out of carton PALC =Job Pack, in carton	EQ-CLIP-U =T-BAR Safety Earthquake Clips ⁽¹³⁾ DF-22W-U =2' x 2' Drywall Frame Kit SK-22-WS =2' x 2' Shallow Surface Mount Kit ^(D) ISHH-01 =Programming Remote for Integrated Sensor ^(D) ISHH-02 =Personal Control Remote for Integrated Sensor ^(D)
Notes ⁽¹⁰⁾ WAA sensor and WPN node to be used with CD driver. ⁽¹¹⁾ WAB and SVPD1 sensor to be used with CD driver. ⁽¹²⁾ WLA sensor to be used with LV driver. Integrated options must be used in conjunction with the associated system and may not be compatible with other options or accessories. Please refer to the following: ^(A) Consult WaveLinX PRO system pages for additional details and compatibility. ^(B) WaveLinX LITE devices are not currently compatible with the WaveLinX Wireless Area Controller. Consult WaveLinX LITE system pages for additional details and compatibility. ^(C) Consult WaveLinX Low-Voltage or DLVP system pages for additional details and compatibility. ^(D) Consult SVPD series system pages for additional details and compatibility.		Notes ⁽¹³⁾ An EQ Grid Clip is recommended for all 9/16" ceiling systems. ⁽¹⁵⁾ Accessories sold separately will be separately analyzed under domestic preference requirements. Consult factory for further information. ^(D) For use with SVPD sensor only. Consult SVPD series system pages for additional details and compatibility.

Product Specifications

Construction

- 3-1/4" Rigid housing is die formed of code gauge prime cold rolled steel
- Full length die-formed stiffeners and unibody endplate for added strength
- Four auxiliary fixture end tie-back points provided
- Endplates have integral Grid-lock feature for safety and convenience
- 1/2" Regressed extruded aluminum door

Hinging/Latching

- Door assembly hinges down for easy access from below
- Positive cam action steel latches with powder coat matte white finish
- Safety-lock T-hinges allow hinging and latching either side

Frame/Shielding

- Proprietary Perceive™ optical system enables dynamic visual depth on a flat surface
- Bottom surface can be wiped down for easy cleaning and maintenance
- Durable lens system is >.107" thick and includes diffuser, 3D elements and anti-glare

Controls

- 0-10V dimming to 1% standard
- WaveLinX wireless sensor compatible for standalone, controlled, connected, and IoT capability
- SVPD sensor compatible for out-of-the-box functionality
- Low-voltage sensor and driver compatible for WaveLinX Low-Voltage and DLVP applications
- DALI 2.0, Lutron, and step-dimming available

Light Engine / Electrical

- LED's available in 3000K, 3500K, 4000K, or 5000K at 80 CRI or 90 CRI minimum
- Color accuracy \leq 3-Step MacAdam ellipse (SDCM)
- TM21 life at 72,000 hours up to L86 and calculated L70 exceeds 170,000 hrs
- Drivers available in 120-277V and 347V

Emergency Battery Pack Option

- 120V-277V integral emergency battery pack comes in 7-watts, 10-watt, or 14-watts
- Self-diagnostic emergency battery available in 10 or 14-watts (NFPA 101@ Life Safety Code®)
- Constant power to the LED system for controlled, predictable discharge
- Integrated test switch/indicator light visible from floor
- Min. 90-minute backup period for code compliance
- Integral emergency transfer relay available for generator equipped power systems

Finish

- Multistage, iron phosphate pretreatment
- Housing is high reflectance pre-paint white finish
- Frame assembly is powder coat matte white finish

Compliance

- IC rated for insulation contact
- cULus listed for damp locations for 25°C ambient environments
- RoHS compliant
- Tested according to IESNA LM-79 and LM-80 procedures
- Stated life per TM21 standards
- Can be used to comply with California Title 24 Non-Residential
- Meets IEEE 1789-2015 Standard Recommended Practice for LED flicker light modulation
- Contributes to meeting several WELL™ v1 and v2 Features

Warranty

- Five year warranty standard. Optional ten year warranty available.

Photometric Data

[View IES files](#)

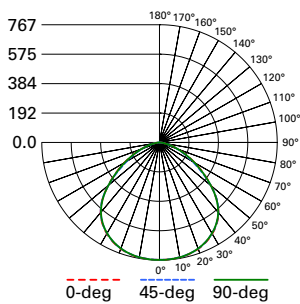

22PD-20-PB1-L835

Electronic Driver
 Linear LED 3500K
 Spacing criterion: (II) 1.33 x mounting height, (\perp) 1.32 x mounting height
 Lumens: 2010
 Input Watts: 16.1W
 Efficacy: 125 LPW
 Test Report: 22PD-20-PB1-L835.IES

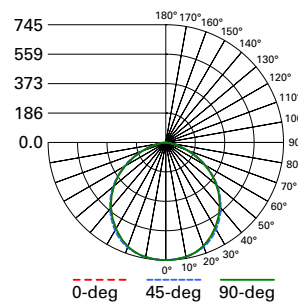

22PD-20-PC3-L835

Electronic Driver
 Linear LED 3500K
 Spacing criterion: (II) 1.25 x mounting height, (\perp) 1.25 x mounting height
 Lumens: 2000
 Input Watts: 16.1W
 Efficacy: 124 LPW
 Test Report: 22PD-20-PC3-L835.IES

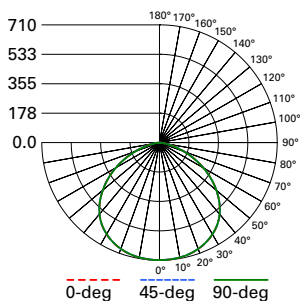

22PD-20-PP3-L835

Electronic Driver
 Linear LED 3500K
 Spacing criterion: (II) 1.33 x mounting height, (\perp) 1.33 x mounting height
 Lumens: 2034
 Input Watts: 16.1W
 Efficacy: 126 LPW
 Test Report: 22PD-20-PP3-L835.IES

Energy and Performance Data

Electrical Performance - Perceive 2x2

Lumen Package	CCT	Delivered Lumens						Power	Efficacy (LPW)						Current (A)	
		Bevel (PB1)	PARAmid (PC3)	Prism (PP3)	Waves (PW1)	Leaves (PL1)	Ripple (PR1)	Watts	Bevel (PB1)	PARAmid (PC3)	Prism (PP3)	Waves (PW1)	Leaves (PL1)	Ripple (PR1)	120V	277V
2000	3500	2010	2000	2034	2020	1995	1884	16.1	125	124	126	125	124	117	0.13	0.06
2500	3500	2495	2482	2525	2507	2476	2338	19.9	125	125	127	126	125	118	0.17	0.07
3000	3500	3027	3011	3064	3042	3004	2837	24.6	123	122	125	124	122	115	0.21	0.09
3500	3500	3507	3489	3550	3524	3481	3287	28.8	122	121	123	122	121	114	0.24	0.10
4000	3500	4012	3991	4061	4032	3982	3760	32.6	123	122	124	124	122	115	0.27	0.12
4500	3500	4532	4509	4587	4555	4498	4247	37.8	120	119	121	121	119	112	0.31	0.14
5000	3500	4991	4965	5052	5016	4954	4677	41.9	119	118	120	120	118	112	0.35	0.15
5500	3500	5490	5462	5557	5517	5449	5145	45.4	121	120	122	122	120	113	0.38	0.16
6000	3500	6003	5972	6076	6033	5958	5626	52.5	114	114	116	115	114	107	0.44	0.19
7000	3500	7009	6973	7094	7044	6957	6569	63.9	110	109	111	110	109	103	0.53	0.23
8000	3500	8008	7966	8105	8048	7948	7505	73.4	109	108	110	110	108	102	0.61	0.27

Optical Performance - Perceive 2x2

Lumen Package	CCT	UGR [CIE 190:2010] (1) (4H, 8H; Reflectance: 70% Ceiling, 50% Wall, 20% Ref. Plane)						Max Luminance [45-90 Deg from NADIR] (2) (CD/M ²)					
		Bevel (PB1)	PARAmid (PC3)	Prism (PP3)	Waves (PW1)	Leaves (PL1)	Ripple (PR1)	Bevel (PB1)	PARAmid (PC3)	Prism (PP3)	Waves (PW1)	Leaves (PL1)	Ripple (PR1)
2000	3500	15.8	17	17.1	17.0	16.7	16.7	2043	1894	1976	1953	1918	1880
2500	3500	16.6	17.7	17.9	17.7	17.4	17.4	2536	2351	2453	2425	2381	2334
3000	3500	17.2	18.4	18.6	18.4	18.1	18.1	3077	2852	2976	2942	2888	2831
3500	3500	17.8	18.9	19.1	18.9	18.6	18.6	3565	3304	3447	3408	3346	3280
4000	3500	18.2	19.4	19.5	19.4	19.1	19.1	4078	3780	3944	3899	3828	3753
4500	3500	18.6	19.8	20	19.8	19.5	19.5	4606	4270	4455	4404	4324	4239
5000	3500	19	20.1	20.3	20.1	19.9	19.9	5073	4703	4906	4850	4762	4668
5500	3500	19.3	20.5	20.6	20.5	20.2	20.2	5580	5173	5397	5335	5238	5135
6000	3500	19.6	20.8	20.9	20.8	20.5	20.5	6102	5656	5901	5834	5728	5615
7000	3500	20.2	21.3	21.5	21.3	21.0	21.0	7124	6604	6890	6811	6688	6556
8000	3500	20.6	21.8	21.9	21.8	21.5	21.5	8140	7545	7872	7782	7641	7490

Nominal Lumen Maintenance

TM-21 Lumen Maintenance (72,000 hours)	Theoretical L70 (hours) ⁽¹⁾
> 86%	> 170,000

Notes: (1) Theoretical values represent estimations. Refer to LED Product Lifetime Prediction, IES PS-10-18, that explains proper use of IES TM-21 and LM-80.

Lumen Adjustment Factors

CCT Multiplier	80 CRI	90 CRI
3000K	0.953	0.826
3500K	1.000	0.837
4000K	1.005	0.849
5000K	1.027	0.894

Shipping Data

Series Catalog No.	Weight (lbs)	Units per Pallet 49"L x 52"W x 55"H
22PD	13	18

Example of Lumen Adjustment Calculation

22PD-40-PB1-L835 at 80CRI at 5000K

Lumen Adjustment Factor = 1.027

Total Light Output =

4,012 lm x 1.027 = 4,120 lm

Efficacy = $\frac{4,120 \text{ lm}}{32.6 \text{ W}}$ = 126 lm/W

Dimensional and Mounting Details

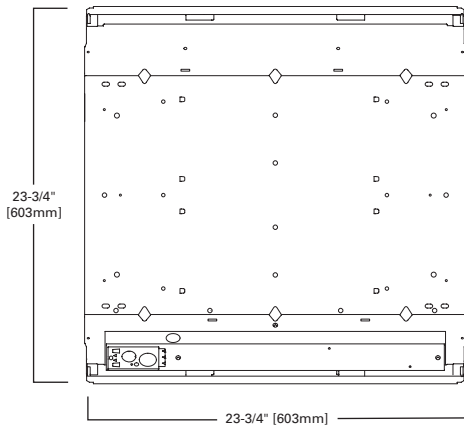
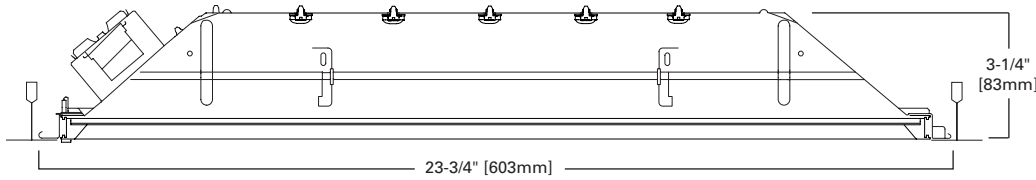

Ceiling Compatibility

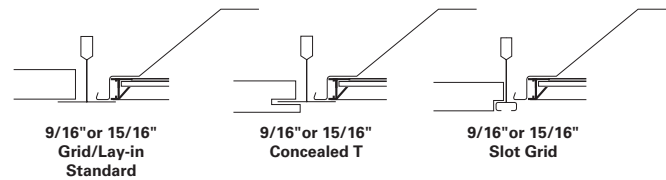

Ceiling Mounting Choices

Application	Catalog	UPC	Description
Hard Ceiling Recessed	DF-22W-U	662401232963	2x2 Dry Wall Frame Kit
Surface Mount	SK-22-WS	080083719402	2x2 Shallow Surface Mount Kit

Perceive Optic Patterns

Cooper Lighting Solutions' Perceive™ technology enables a wide-variety of 3D visual forms; all on an easy-to-clean flat surface.

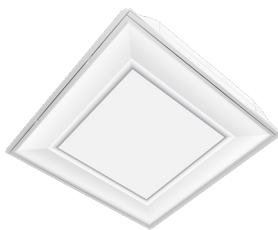

Bevel (PB1):
Distinct regressed coffer appearance

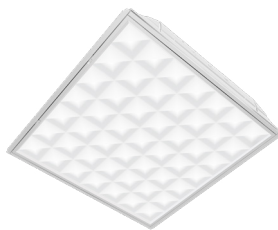

PARAMid (PC3):
Dynamic pyramid stud 3\"/>



Prism (PP3):
Diamond prismatic geometry



Waves (PW1):
Energetic flowing waves, sculpted appearance



Leaves (PL1):
Subtle organic leaves



Ripple (PR1):
Soft undulating form

Control Systems

- WaveLinx PRO Wireless
- WaveLinx LITE Wireless
- WaveLinx Wired

The Perceive with WaveLinx offers no-hassle lighting control with multiple luminaire level control solutions.

WaveLinx PRO is used for applications where spaces need to be connected to a lighting or building management system and to help building owners improve their operations, building environment, and tenants' experience by leveraging the data generated by the sensors. The WaveLinx PRO devices communicate with each other via the WaveLinx Area Controller which coordinates the data traffic between the devices, lighting apps and CORE platform. The WaveLinx Area Controller also hosts the time clock required if spaces need to be turned on/off at a specific time.

The WaveLinx PRO Sensor offers built-in occupancy and daylighting controls as well as luminaire level control including white tuning while the WaveLinx PRO Node offers luminaire level control and white tuning. If opting for the WaveLinx PRO Node option, a PRO Ceiling Sensor will most likely be needed within the space to control the lights based on occupancy and daylight levels.

WaveLinx LITE is used for single spaces where there is no need to manage the spaces remotely or exchange the sensor data with other sub-systems within the building or smart applications.

The WaveLinx LITE Sensor offers built-in occupancy and daylighting controls as well as luminaire level control.

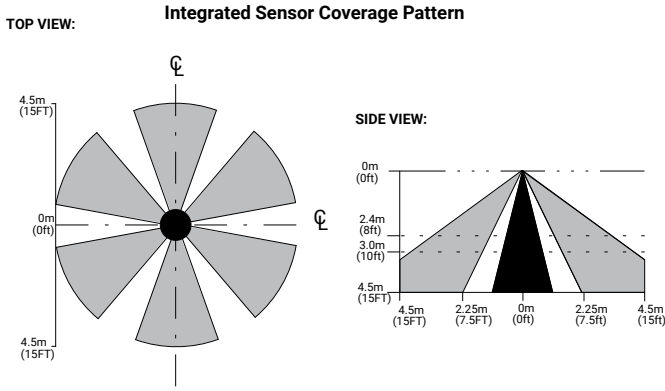
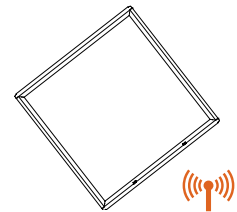
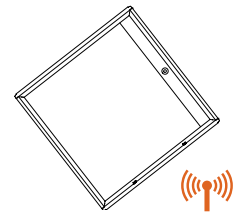
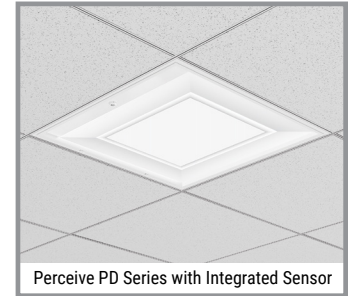

Note: Installation of integrated sensors within 3-ft (1m) of HVAC air vents is not recommended. The pattern shown is intended solely as a general guide and is not to scale.

Systems comparison chart

Cooper Lighting Solutions provides many lighting system solutions designed to satisfy code requirements and meet the unique needs of any project.



Luminaire with standalone sensor

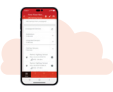

Standalone Spaces WaveLinx LITE



Networked Spaces WaveLinx PRO



Enterprise WaveLinx CORE

	Luminaire with standalone sensor	Standalone Spaces WaveLinx LITE	Networked Spaces WaveLinx PRO	Enterprise WaveLinx CORE
Occupancy	Yes	Yes	Yes	Yes
Daylighting	Yes	Yes	Yes	Yes
Wallstations	-	Yes	Yes	Yes
Gateways	-	-	1 WAC	300 WACs
Devices (MAX)	-	50 per Area (1400 per site)	200 per WAC2	32,500 per CORE Enterprise
Software	-	WaveLinx LITE Mobile App	WaveLinx Mobile App	CORE
Areas	-	28 per Site	50 per WAC2	up to 3,000
Zones	-	16 per Area	16 per Area	up to 9,000
Scheduling	-	-	Local	Global
VividTune™	-	-	Yes	Yes
Plug-Load Control	-	-	Yes	Yes
Low-Voltage Power	-	-	Yes	Yes
Integration	-	-	-	BACnet, API
Dashboards	-	-	-	Energy, Occupancy
Configuration	-	Installer	Technician	Technician / IT

SCALABILITY

