

Project		Catalog #		Type	
Prepared by		Notes		Date	



PrentaLux

411

A-19 LED Lamp Based Luminaire Decorative

Typical Applications

- Hospitality • Office • Commercial • Education • Retail • Healthcare
- National Accounts • Residential • Multi-Family

Interactive Menu

- Order Information [page 2](#)
- Color Selections [page 3](#)
- Texture Selections & Mounting Options [page 4](#)
- Photometric Data [page 5](#)
- Lumen/Wattage/LPW & UGR Data [page 5](#)

Certifications



Filament only.
See page 6



LIVING BUILDING CHALLENGE

Features



Awards



Top Product Features

- PrentaLux 400's are a series of decorative products that utilize Cooper Lighting's 3D Printing technology using an A-19 LED lamp base.
- Modern form available in 8 standard opaque colors and 4 standard transparent/translucent colors with additional On-Demand colors available with possible additional costs and lead times. Please consult factory.
- A19 Lamp based, E26 socket: Frosted lamp, Filament lamp, or no lamp (lamp is provided by others), options.
- Voltage is 120V only.
- 3D printed mounting canopy available in disk or conical shape.
- Black or white power cord.
- BAA compliant. RoHS compliant.
- [Declare compliant](#)
- LBC Red List Free
- Finishes available on [Material Bank](#)
- 5 Year Warranty

Dimensions

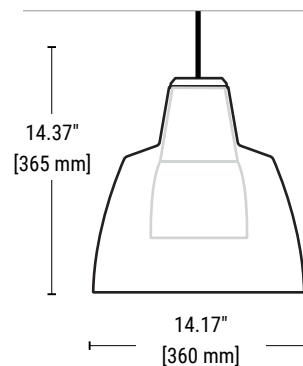

Scale

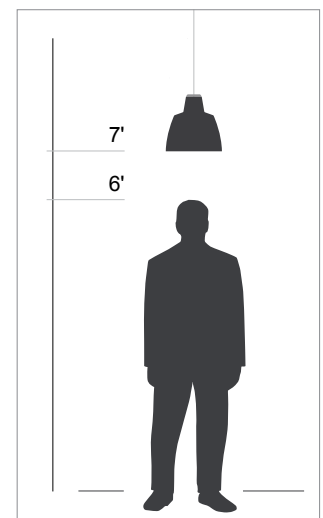

Order Information

SAMPLE CATALOG NUMBER: PRLX-411-FR-120-WHTE-GHL-DS-BK

--	--	--	--	--	--

Domestic Preferences	Brand	Series	Source	Voltage	Shade Color	Shade Texture
<p>[Blank] = Standard BAA = Buy America Act</p>	PRLX	411	<p>NB = No Lamp Supplied (Lamp by others) FIL = A19, E26 LED Filament lamp, 2700K, 60W incandescent equivalent FR = A19, E26 LED Frosted lamp, 3000K, 60W incandescent equivalent</p>	120 = 120V Voltage	<p>Standard Translucent Colors TRWH = Translucent White DIFF = Diffuse CLER = Clear SMGY = Smokey Gray</p> <p>Standard Opaque Shade Colors: WHITE = White BLAK = Black GRAY = Gray ROSE = Rose CAPP = Cappuccino SAGE = Sage BRNZ = Bronze BRSS = Brass</p> <p>XXXX² = On-Demand Color</p>	<p>RHL = Refined Horizontal Lines GHL = Grooved Horizontal Lines GRD = Grid PNS = Pinstripe DVL = Deep Vertical Lines FAC = Facets</p> <p>XX² = Other Shade Texture</p>
<p>Notes</p> <p>1. Only product configurations with this designated prefix are built to be compliant with the Buy American Act of 1933 (BAA). Please refer to DOMESTIC_PREFERENCES_website for more information. Components shipped separately may be separately analyzed under domestic preference requirements.</p>	Notes	Notes	<p>Notes</p> <p>1. A19 lamps up to 50W may be used in these fixtures (supplied by others). 2. Dimming is determined by lamp selected</p>	Notes	<p>Notes</p> <p>1. See page 4 for color options. 2. On-Demand colors available with possible extended lead times and additional costs. Consult factory. See page 4 for additional color options. 3. Finial will match shade color. Clear, Translucent White, and Diffuse shades will include white finial. Smokey Gray shades will include black finial. Contact factory for non-standard finial color requests.</p>	<p>Notes</p> <p>1. See page 5 for texture details and options. 2. Consult factory to request other textures. Shop drawings may be required. Extended lead times, additional costs, and minimum order quantity possible.</p>

Continue here to make complete selections

--	--	--	--	--	--

Mounting Canopy	Mounting Canopy Cord Color
<p>DW = Disk - White DB = Disk - Black DC = Disk canopy matches outer shade color (opaque color only)</p> <p>CW = Conical - White CB = Conical - Black CC = Conical canopy matches outer shade color (opaque color only)</p>	<p>BK = Black power cord and black socket WH = White power cord and white socket</p>
Notes	Notes

Product Specifications

Construction

- PrentaLux 400s series consist of a lamp / socket combination that uses an A-19, E26 Socket LED lamp base and a proprietary additive manufacturing process for the polycarbonate shade and components.
- 400 series shades utilize a proprietary, impact resistant polycarbonate for maximum durability
- The polycarbonate used for PrentaLux fixtures is bio-circular and thermally, mechanically and optically optimized for professional/commercial installations. Designed, engineered, and printed in the United States.

LED Lamp

- Available in Filament based LED lamp, Frosted based LED lamp, or no lamp (supplied by others), options.
- Frosted LED lamp is 15W equivalent to 60W incandescent lamp. 15,000 hour lamp life. 3000K @90 CRI. Output is 800 lumens. E26 base A19 lamp shape. Dimmable. Efficacy is 53.3 LPW.
- Filament LED lamp is 15W equivalent to 60W incandescent lamp. 15,000 hour lamp life. 2700K @90 CRI. Output is 800 lumens. E26 base A19 lamp shape. Dimmable. Efficacy is 53.3 LPW.
- Approved for use with lamps up to 50W (by others).
- Dimming is determined by the lamp selection

Optics

- Output determined per shade shape, color, and transparency/translucency/opaqueness. See polar plots and UGR data on page 6.
- 400 series pendants come with a translucent inner diffuser to deliver consistent illumination.

Electrical

- Standard 120V.

Mounting

- Mounting options include UL certified cord and option of 3D printed disk shape or conical shape mounting canopy.

Finish

- 6 different shade textures available with modern industrial designs.
- Shade available in 8 standard opaque colors and 4 standard transparent/translucent colors with additional On-Demand colors available. Additional costs and lead times may apply. Please consult factory.
- The 'Finial' recommendation is to match the outside shade color, with the following exceptions: When outer shade is transparent or translucent, an opaque finial color must be chosen. Black finial is default selection for Smokey Gray Outer shade color and White finial is default selection for Clear Outer Shade color.
- Finishes are available for review on [Material Bank](#) under Cooper Lighting Solutions PrentaLux brand.

Lengths

- Fixture comes with 10ft cord. Lengths up to 25 ft possible. (Consult factory for length longer than 10ft as longer lead times apply).

Weight

- Product is light weight and much easier to install than traditional pendants.
- 411 fixture weighs approximately 3.4lbs.

Environment

- Suited for 25° ambient. Dry location only.

Compliance

- All products are light weight and much easier to install than traditional pendants.
- Filament material is UL certified.
- Declare Compliant, LBC Red List Free, ISCC certified
- BAA compliant
- RoHS compliant
- Not to be installed in food prep areas and hazardous environments which may expose the product to pollutants such as oil, grease, or VOCs.
- IK02 impact rated. Not for installations in locations such as gymnasiums, arenas, sports complexes, multi-purpose rooms, and any other locations where the fixture potentially will be subject to impacts from external sources.

Sustainable Product Specifications

- PrentaLux 3D printed parts are produced with at least 55% mass balanced bio-circular materials.
- 80% of the 411 light fixture is made of 3D printed material.
- ISCC certified. Certification applies only to 3D printed material. See page 8.
- Declare compliant
- LBC Red List Free
- See pages 7-8 for additional sustainability details.

Mounting - Canopy Options

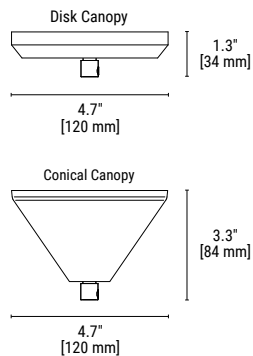

Canopy Colors

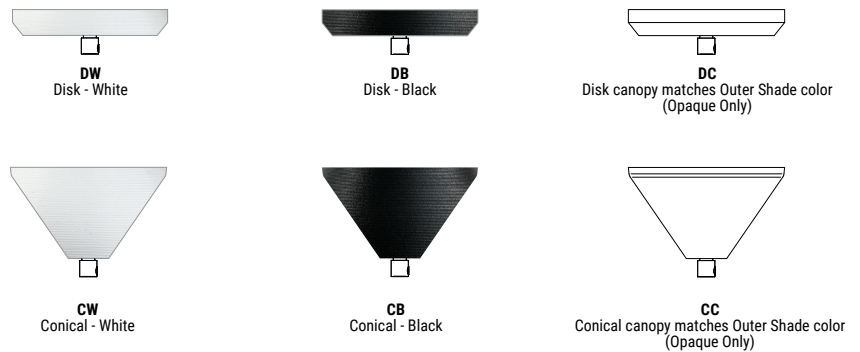

Standard Transparent/Translucent Shade Colors

Not available for Top Finial



CLER - Clear



DIFF - Diffuse White

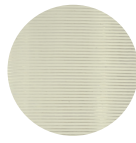

TRWH - Translucent White

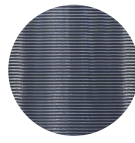

SMGY - Transparent Smokey Gray

Standard Opaque Shade & Top Finial Colors



WHITE - White



BLAK - Black

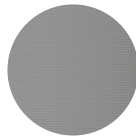

GRAY - Gray

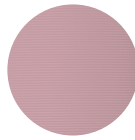

ROSE - Rose



CAPP - Cappuccino

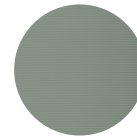

SAGE - Sage

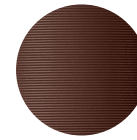

BRNZ - Bronze



BRSS - Brass

On-Demand Transparent Shade Colors

These special color options may have extended lead times and/or additional costs. Please consult factory. Not available for Top Finial



TRBL - Transparent Blue

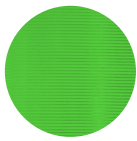

TRGR - Transparent Green

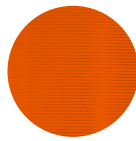

TROR - Transparent Orange

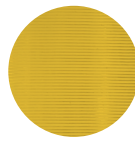

TRYE - Transparent Yellow

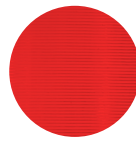

TRRE - Transparent Red

On-Demand Opaque Shade & Top Finial Colors

These special color options may have extended lead times and/or additional costs. Please consult factory.



ENGR - Enamel Green



MEGR - Metallic Green



MCHA - Matcha

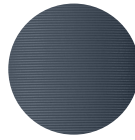

STBL - Steel Blue

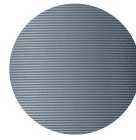

MEBL - Metallic Blue

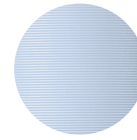

MYBL - Misty Blue

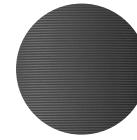

DKGY - Dark Gray

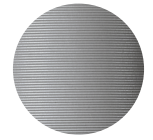

SLVR - Silver

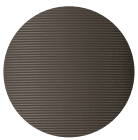

STBR - Stone Brown

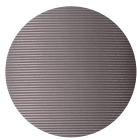

MEPU - Metallic Purple

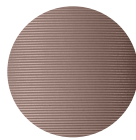

RGLD - Rose Gold



CITR - Citrona



CRWH - Cream White

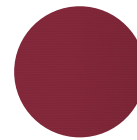

BURG - Burgundy

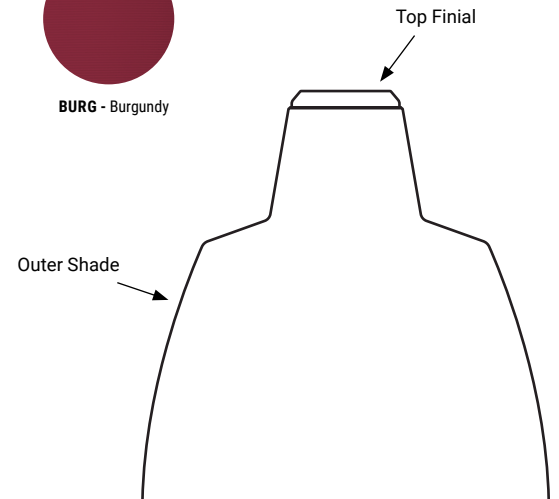

Shade Textures

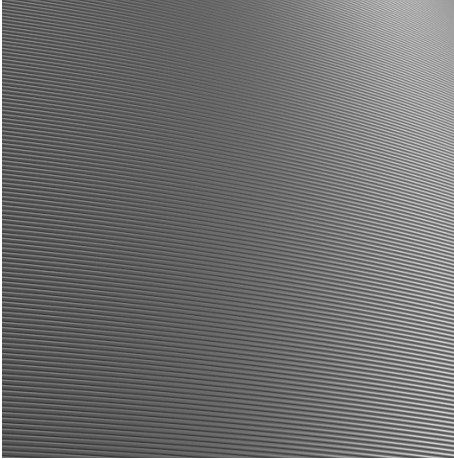

Refined Horizontal Lines
(RHL)

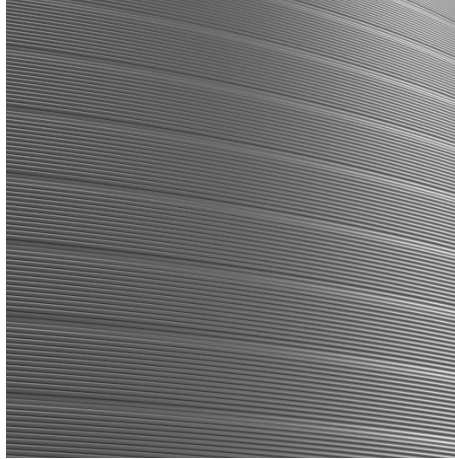

Grooved Horizontal Lines
(GHL)

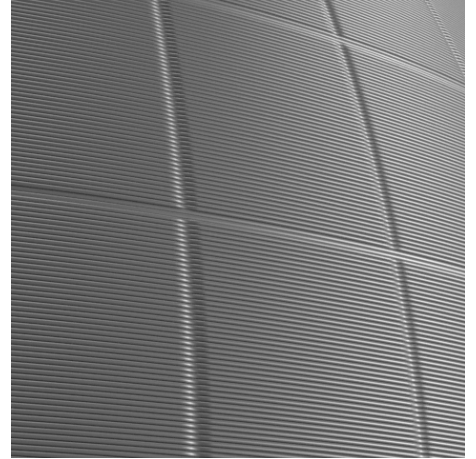

Grid
(GRD)

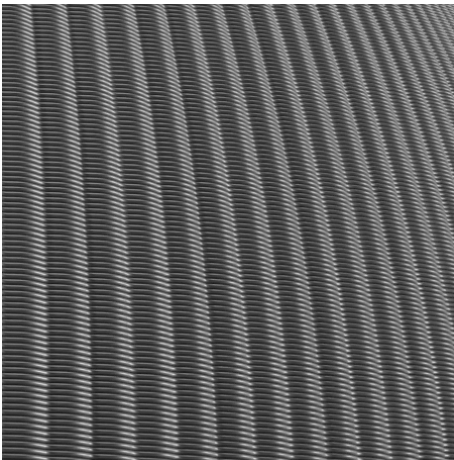

Pinstripe
(PNS)

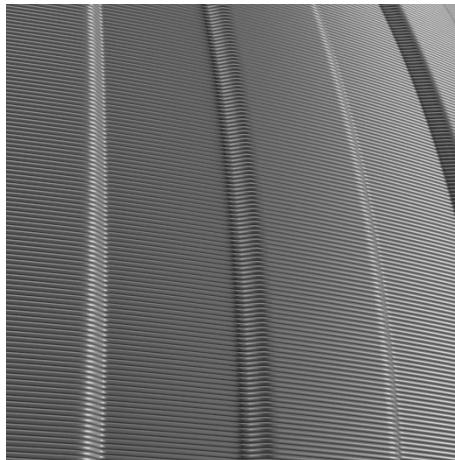

Deep Vertical Lines
(DVL)

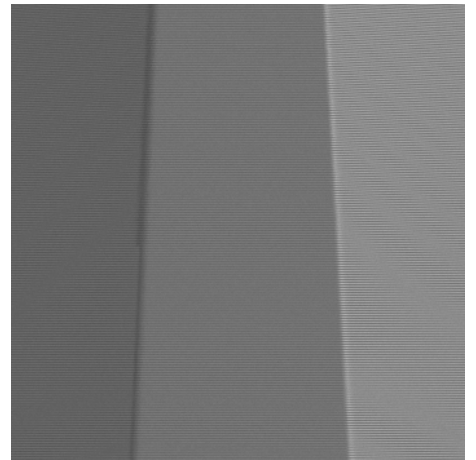

Facets
(FAC)

Photometric Data

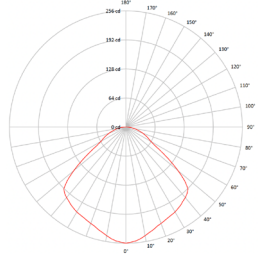
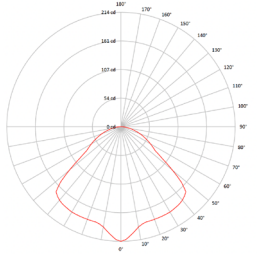
PRENTALUX - 411				
	411 - Frosted Lamp (White Shade Color)		411 - Filament Lamp (White Shade Color)	
Filename	411-FR-120-WHST-RHL-TFIN-DW-WH.ies		411-FIL-120-WHST-RHL-TFIN-DW-WH.ies	
Test No.	G2-2210-802-33		G2-2210-802-24	
Lumcat	411-FR-120-WHST-RHL-TFIN-DW-WH		411-FIL-120-WHST-RHL-TFIN-DW-WH	
Lumens	645.3 Lm		560.1 Lm	
Input Watts	7.93 W		7.78 W	
Efficacy	81.4 Lm/W		72.0 Lm/W	
CCT	3000K		2700K	
SC (0/90/45)	1.27 / 1.27 / 1.45		1.31 / 1.31 / 1.48	

UGR Data

Fixture Type	CCT	UGR [CIE 190:2010] ⁽¹⁾ (4H, 8H; Reflectance: 70% Ceiling, 50% Wall, 20% Ref. Plane		MAX LUMINANCE [45-90 DEG FROM NADIR] ⁽²⁾ (CD/M ²)	
		90 CRI		90 CRI	
		Frosted	Filament	Frosted	Filament
411	3000K (frosted) /2700K (filament)	12.5	12.5	1209	1077

Notes: (1) For other UGR data for room or reflective ceiling plans please see technical data on website. (2) For other CCT please see technical data on website. (3) Averages taken over different colors. Tables available upon request.

Lumens, Wattage, and LPW Tables for 3 Product Colors (Clear, White, Black)

Frosted	Fixture Type	Lumens/Color			Wattage (Watts)	LPW		
		Clear	White	Black		Clear	White	Black
	411	812	645	259	8	102	81	32

Filament	Fixture Type	Lumens/Color			Wattage (Watts)	LPW		
		Clear	White	Black		Clear	White	Black
	411	757	560	143	8	95	70	18

Lumens per CCT

			LED A19 - 60W Incandescent		WATTS	EFFICACY
CRI	CCT	Type	Base	Lumens		
90	2700	Filament	E26	800	8.0	100%
	3000	Frostd	E26	800	8.8	91%

PrentaLux is committed to making sustainable lighting a reality

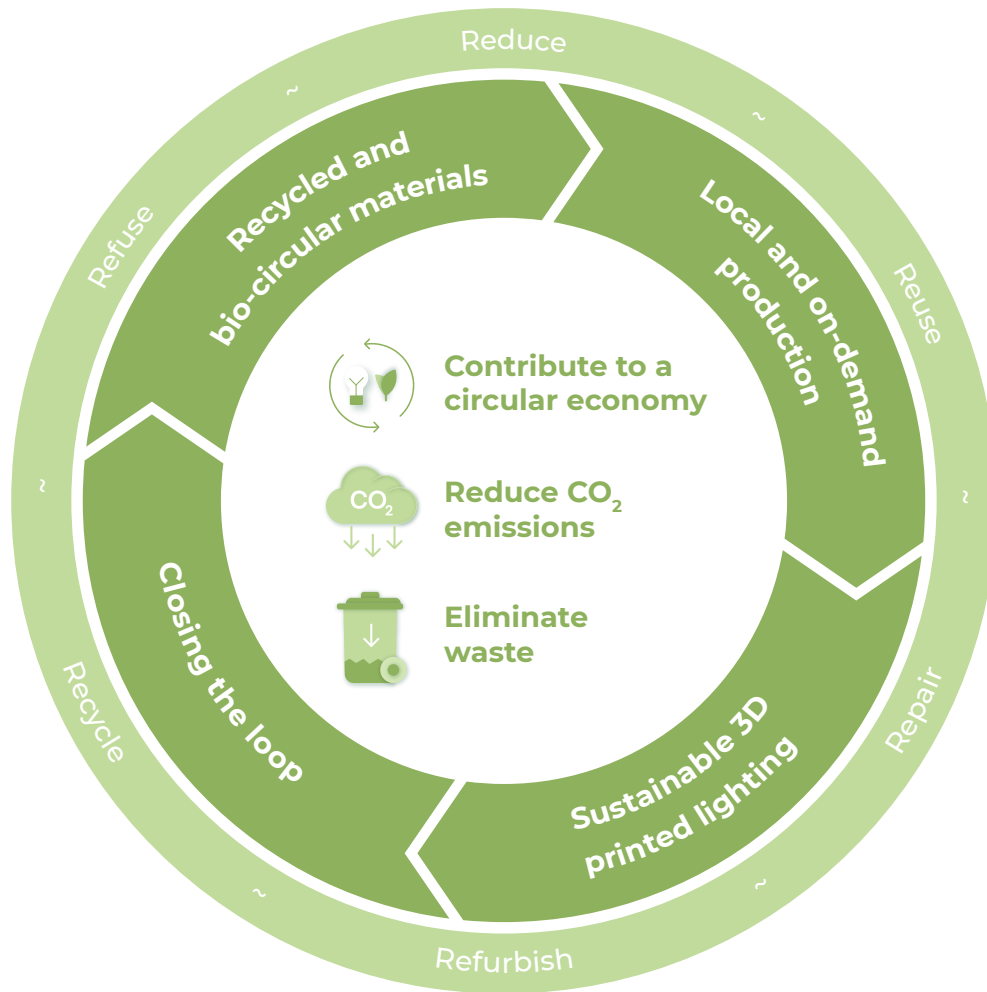

Sustainability

PrentaLux is setting a new benchmark for sustainability in performance lighting. We are deeply committed to reducing CO2 emissions as a vital part of our efforts to combat climate change. Our ambition is to become truly circular in our 3D printing activities. PrentaLux products maximize sustainability by reducing carbon emissions, reducing components and assembly time through the innovative design and technology of 3D printing, reusing our misprints that reduce our carbon footprint, and by utilizing recycled plastics and repurposed waste from food processing and wood pulp industries as the feedstock for PrentaLux 3D printing filaments.



REDUCE

3D printing can save up to 76% lower carbon emissions on material supply and manufacturing. This data is based on a lifecycle comparison of a traditionally manufactured downlight and a 3D printed downlight.



REDUCE

Up to 28% lower carbon emissions in transport. PrentaLux products are manufactured in the US to improve lead times and lessen transportation costs, reducing carbon emissions compared to traditionally manufactured products *(based on a downlight comparison study)*



REUSE

The cardboard and paper packaging materials used to ship PrentaLux products, are themselves, 80% recycled paper at the very least.



RECYCLE

Our 3D printed parts are created with over 55% recycled or bio-circular materials.

Material Sustainability through Production and Supply Chain



Each of our 3D printing manufacturing plants have been audited by the ISCC (International Sustainability and Carbon Certification) organization to verify the implementation and use of environmentally, socially and economically sustainable production and materials.

** PrentaLux products will convert to printing our 3D parts with over 55% recycled or bio-circular materials (using an ISCC certified mass balance approach). Bio-circular materials are raw materials from ISCC Plus certified waste streams and residues including tall oils from the wood processing industry or used cooking oil from the food processing industry.*

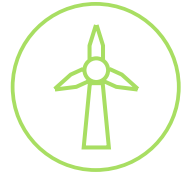

CARBON NEUTRAL

PrentaLux products are produced in a carbon neutral manufacturing facility where over 99% of generated waste is diverted from landfills

80%
of 411 fixture is made with 3D Printed material

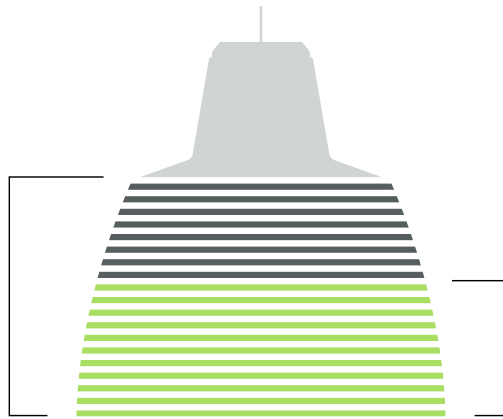

55%
PrentaLux 3D printed parts are produced with at least 55% mass balanced bio-circular materials

Material Transparency



LIVING BUILDING CHALLENGE™

The ILFI (International Living Future Institute) has created a program where manufacturers can disclose the components or “ingredients” of a product. This disclosure has a rating system that shows transparency in the materials chosen in developing products, and whether there are any chemicals of concern, to help meet the requirements of leading green building standards that support human and environmental health.



LBC Red List Free

- Disclosed 100% at content inventory of 100ppm
- Suitable as a compliance pathway for LEED v4.1 Material Ingredients credit Option 1 Material Ingredient Reporting
- Suitable as a compliance pathway for WELL v2 Feature X07 Materials Transparency Parts 1 and 2

To see the full listing of Cooper Lighting products that participate in Declare, click [here](#).

