

Project		Catalog #		Type	
Prepared by		Notes		Date	



Shaper

Shaper Sense™ Drum - Duo

Acoustic Lighting
Pendant Luminaire
Suspended Direct/Indirect

Typical Applications

- Office • Education • Healthcare • Hospitality • Retail
- Code-Compliance Areas • Co-working

Compliance and Award Winning Family

Systems | Certification | Partnerships | Awards



Interactive Menu

- Order Information page 2-3
- Felt Color Selections page 3
- Mounting commendations page 4
- IES Photometry & UGR Data page 5-6
- Acoustic Data, cleaning & maintenance page 6
- Product Warranty

Top Product Features

- Shaper Sense is an award winning and patented acoustic lighting product series that merges the concepts of light and sound absorption. Select from 96 Base layer (BL) felt colors and 96 Border Edge Band (BEB) colors.
- Light is created by an edge-lit LED circular panel with an array of patterns that produce uniform visual distribution.
- Sound absorbing acoustic panels are designed with industry leading FilzFelt™ acoustic materials.
- Available in 96 felt colors for the outer shade and 96 felt colors for the border edge band.
- Noise Reduction Coefficient (NRC) = 1.3, Sound Absorption Average (SAA) = 1.32.
- FilzFelt felt is steam cleanable to 200° F / 93.3° C and acoustic sound absorbing substrate materials can be cleaned with bleach and disinfectants.
- Options to meet Buy American Act requirements

Dimensions

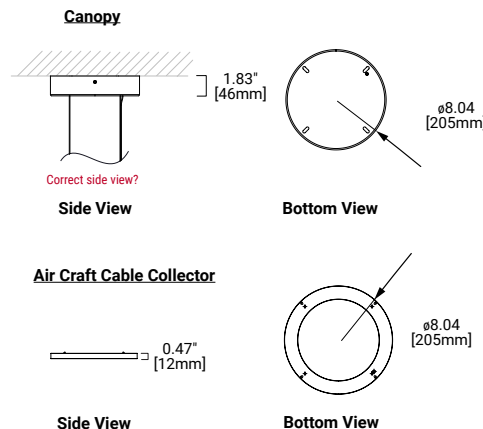
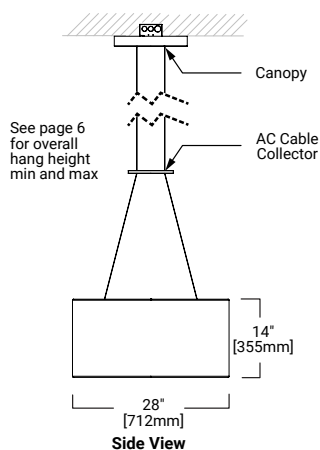

Scale

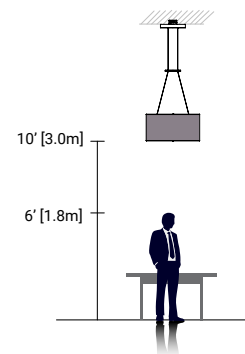

additional product diagrams

Order Information

FIXTURE NUMBER SAMPLE: **ShSe-DRUM-DUO-1-L40-80-UNV-CW-STD-BL100-BEB170**

Domestic Preferences	Series	Shape / Family	Type	Light Level (Lumens Wattage)	Color Temp (CCT)	CRI	Voltage	Mounting	Driver / Dimming
Domestic Preferences	Series	Shape / Family	Type	Light Level (@ 80CRI, 4000K)	Color Temp (CCT)	CRI	Voltage	Mounting	Driver / Dimming
Blank =Standard BAA =Buy American Act	ShSe = Shaper Sense	DRUM = Drum Fixture	Duo = 2 felt color selections	1 = 4176 lms/ 29W/ 148 LPW 2 = 6262 lms/ 46W/ 138 LPW 3 = 8228 lms/ 61W/ 136 LPW	L30 = 3000K L35 = 3500K L40 = 4000K	80 = 80 CRI 90 = 90 CRI	UNV = Universal Voltage (120-277V)	CW =Canopy mount - White CB =Canopy mount - Black CS =Canopy mount - Silver (works for surface, open structure, and gypsum ceilings)	STD = 0-10V (1%) Dimming DCD = 0-10V (0.1%) Dimming LH1 = Lutron Hi-Lume 1% Eco System Dimming*
Notes Only product configurations with this designated prefix are built to be compliant with the Buy American Act of 1933 (BAA). Please refer to DOMESTIC PREFERENCES website for more information. Components shipped separately may be separately analyzed under domestic preference requirements.	Notes	Notes	Notes	Notes See page 4 for all lumen, power, and efficacy values	Notes	Notes 80 CRI longer lead times. Consult factory	Notes	Notes Air craft cable Collector is same color as canopy mount	Notes 1. Not available with light level 3

Base layer (BL)

Border Edge Band (BEB)

Accessories (Optional)

Finish				Accessories (Optional)
Base layer (BL)		Border Edge Band (BEB)		
BL487 =Pfirsich BL023 =Koralle BL945 =Drachenfrucht BL221 =Himbeere BL136 =Weinrot BL209 =Bordeaux BL102 =Kirsche BL201 =Rot BL125 =Tomate BL179 =Hellrot BL180 =Terracotta BL173 =Mango BL105 =Rost BL573 =Kupfer BL116 =Orange BL495 =Abricot BL124 =Gelb BL131 =Honig BL509 =Kamel BL550 =Ocker BL274 =Senf BL108 =Zitrone BL403 =Mais BL535 =Sesam BL203 =Vanille BL027 =Kartause BL384 =Lind BL713 =Kiwi BL377 =Maigrün BL732 =Farn BL378 =Oliv BL260 =Sprießen BL156 =Loden BL343 =D'Grün BL435 =Smaragd BL625 =Pinie BL248 =Jade BL472 =Minze BL575 =Salbei BL483 =Adria BL548 =Türkis BL312 =Lagune BL345 =Pazifik BL308 =Petrol BL698 =Dunst BL405 =Stahl BL215 =Meer BL540 =Ozean	BL533 =Indigo BL282 =D'Blau BL111 =Traube BL626 =Azur BL647 =Kobalt BL686 =Enzian BL272 =Royal BL286 =H'Blau BL995 =Wasser BL458 =Bekwölkt BL284 =Himmel BL613 =Gletscher BL551 =Eis BL573 =Immergrün BL099 =Lila BL667 =Amethyst BL242 =Pink BL640 =Granat BL634 =Erröten BL671 =Pfungstrose BL255 =Flieder BL269 =Violett BL437 =Aubergine BL250 =Trüffelbraun BL220 =Rehbraun BL411 =Alpaka BL190 =Natur-meliert BL200 =Natur BL331 =Sahara BL311 =Mandel BL467 =Sand BL260 =Sprießen BL100 =Wollweiss BL110 =Rohweiss BL160 =Beige BL529 =Champagner BL150 =Weiss BL428 =Silber BL427 =Stein BL021 =Beton BL170 =Asche BL423 =Hellgrau BL408 =Taupe BL175 =Graphit BL425 =Taubengrau BL446 =Kohle BL300 =Anthrazit BL426 =Schwarz	BEB487 =Pfirsich BEB023 =Koralle BEB945 =Drachenfrucht BEB221 =Himbeere BEB136 =Weinrot BEB209 =Bordeaux BEB102 =Kirsche BEB201 =Rot BEB125 =Tomate BEB179 =Hellrot BEB180 =Terracotta BEB173 =Mango BEB105 =Rost BEB573 =Kupfer BEB116 =Orange BEB495 =Abricot BEB124 =Gelb BEB131 =Honig BEB509 =Kamel BEB550 =Ocker BEB274 =Senf BEB108 =Zitrone BEB403 =Mais BEB535 =Sesam BEB203 =Vanille BEB027 =Kartause BEB384 =Lind BEB713 =Kiwi BEB377 =Maigrün BEB732 =Farn BEB378 =Oliv BEB260 =Sprießen BEB156 =Loden BEB343 =D'Grün BEB435 =Smaragd BEB625 =Pinie BEB248 =Jade BEB472 =Minze BEB575 =Salbei BEB483 =Adria BEB548 =Türkis BEB312 =Lagune BEB345 =Pazifik BEB308 =Petrol BEB698 =Dunst BEB405 =Stahl BEB215 =Meer BEB540 =Ozean	BEB533 =Indigo BEB282 =D'Blau BEB111 =Traube BEB626 =Azur BEB647 =Kobalt BEB686 =Enzian BEB272 =Royal BEB286 =H'Blau BEB995 =Wasser BEB458 =Bekwölkt BEB284 =Himmel BEB613 =Gletscher BEB551 =Eis BEB113 =Immergrün BEB099 =Lila BEB667 =Amethyst BEB242 =Pink BEB640 =Granat BEB634 =Erröten BEB671 =Pfungstrose BEB255 =Flieder BEB269 =Violett BEB437 =Aubergine BEB250 =Trüffelbraun BEB220 =Rehbraun BEB411 =Alpaka BEB190 =Natur-meliert BEB200 =Natur BEB331 =Sahara BEB311 =Mandel BEB467 =Sand BEB481 =Sandstein BEB100 =Wollweiss BEB110 =Rohweiss BEB160 =Beige BEB529 =Champagner BEB150 =Weiss BEB428 =Silber BEB427 =Stein BEB021 =Beton BEB170 =Asche BEB423 =Hellgrau BEB408 =Taupe BEB175 =Graphit BEB425 =Taubengrau BEB446 =Kohle BEB300 =Anthrazit BEB426 =Schwarz	WTA =Wavelinx Tile Sensor
Notes		Notes		Notes Order separately. Consult factory for more information.

Ordering Information - Felt Color Chart

Select **BLXXX** for Base Layer Color Selection from chart. XXX = number of color. Ex. BL170 is base layer Asche (170).

Select **BEBXXX** for Border Edge Band Color Selection from chart. XXX = number of color. Ex. BEB286 is border edge band H'Blau (286).



Ordering Example

See page 3 for images of color options.

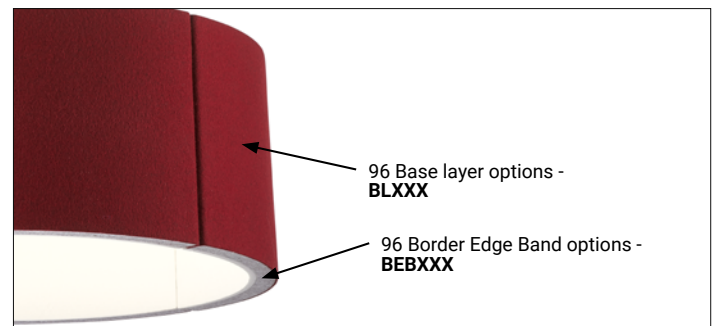

Product Specifications

Construction

- Light Engine is 6063-T5 extruded aluminum and 20 gauge cold rolled steel frame
- Acoustic Light Fixture is supported with max load 132lb cable
- Weight: 32 lbs fully assembled

Electrical

- Standard driver features electronic universal voltage (120-277V/ 50-60 Hz), greater than 0.9 power factor
- Less than 20% harmonic distortion, and ambient temperature of 25°C (77°F). 0-10V dimming standard

LED Optics

- Light Engine is 89.74% transparent
- LPW 140+ in some 3500K and 4000K configurations
- Light Engine offered in 80 and 90 CRI for 3000K, 3500K, and 4000K CCTs.
- UGR data available for Drum products. See page 4 for details.

Mounting

- Acoustic Light Fixture supported by aircraft cable. 12ft adjustable AC cable supplied
- Recommended minimum height of 10" from AC cable collector to Light Engine
- Driver box assembly can mount to any ceiling type: open structure, gyp., or acoustic tile

Note: "Acoustic Light Fixture" refers to Light Engine plus acoustic panels.
 "Light Engine" refers to characteristics of the edge-lit acrylic light assembly unit.

- Acoustic Light fixture can be supported by junction box supporting 50lb load
- Low voltage cable connects to remote driver box assembly
- AC Cable Collector recommended but not required
- Canopy and AC cable collector available in white, black, and silver.

Finish

- Light Engine - Housing is white powder coat paint for superior protection against fade and wear
- Acoustic Panels - Choice of 96 felt colors for the Drum barrel, and 96 choices of felt for the border edge. All felt is 100% Wool Design Felt.
- Sound absorbing substrate is made of a minimum 60%+ recycled content and is 100% recyclable

Compliance

- Light Engine components are UL recognized and are cULus listed for 25°C ambient environments, dry listed
- Acoustic Light Fixture tested per IESNA LM-79
- LM-80 data supplied by LED manufacturer and utilized in TM-21 lumen maintenance projections
- Acoustic Light Fixture tested to ASTM 423C-17 standards and FCC compliant
 - Noise Reduction Coefficient - NRC = 1.3
 - Sound Absorption Average - SAA = 1.32

(Apparent NRC and SAA values calculated from using total test area occupied by light fixtures)
 • 3mm thick 100% wool felt + the acoustic substrates incorporated in the fixtures all have a Class A fire rating. See [FilzFelt](#) website for listings

Environment

- Indoor only, dry listing
- 25°C ambient temperature

Control

- 0-10V dimming standard
- Optional - WaveLinx wireless control systems

Maintenance

- FilzFelt felt can be cleaned with steam cleaner up to 200°F/93.3°C. Acoustic substrate can be cleaned with bleach and disinfectants
- Maintenance and cleaning instructions found [here](#)
- See page 5 for more details on cleaning.

Warranty

- Five year warranty standard

Mounting Information and Recommendations

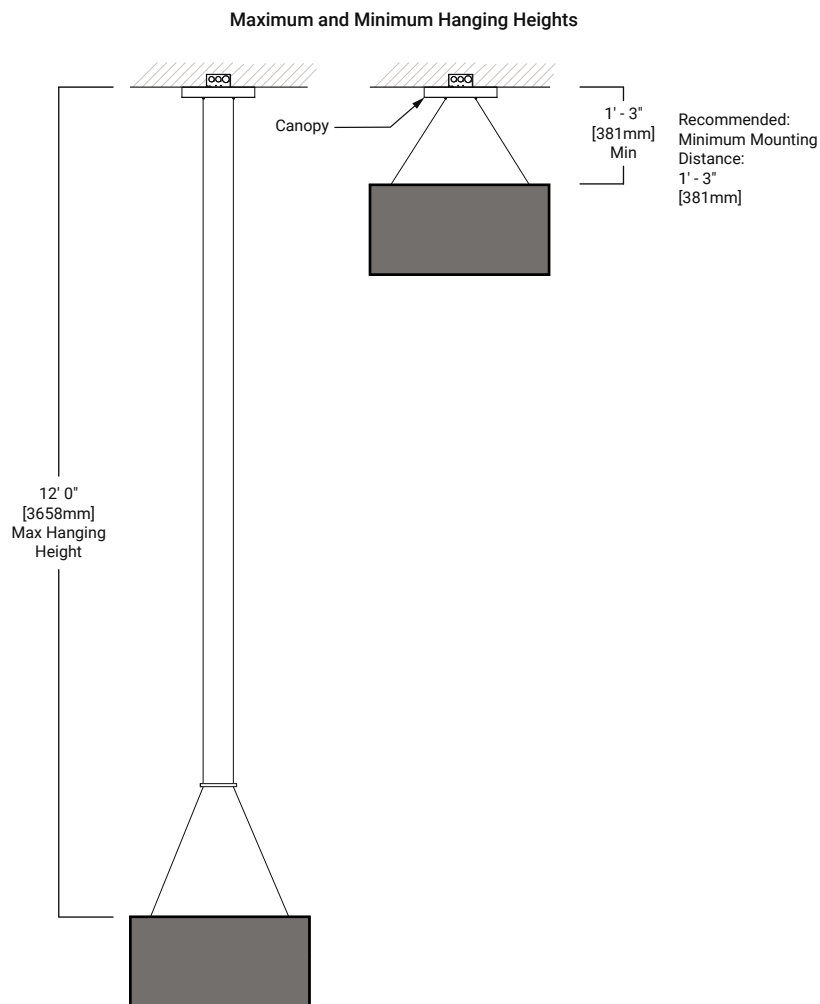
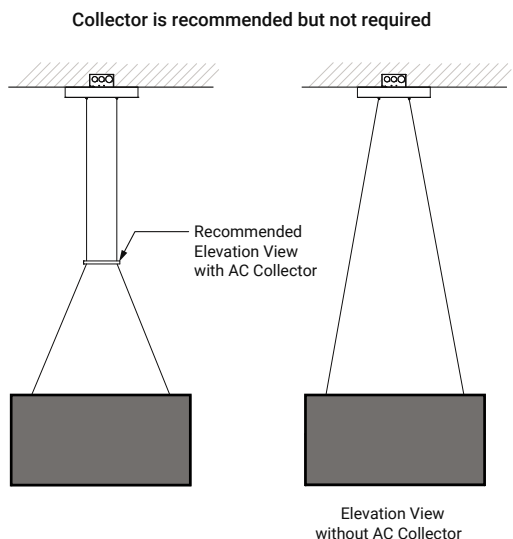

Lumen Maintenance

Ambient Temperature
25°C
Lumen Maintenance: TM-21 (60,000 Hours)
> 80%
Theoretical L70 (Hrs)
> 54,000

Photometric Data

SHAPER SENSE - DRUM DUO - @ 3500K / 90 CRI			
	Light Level 1	Light Level 2	Light Level 3
Filename	ShSe-DRUM-1-L35-90-UNV-STD.ies	ShSe-DRUM-2-L35-90-UNV-STD.ies	ShSe-DRUM-3-L35-90-UNV-STD.ies
Test No.	P402552	P402559	G3-2004-737-4
Lumcat	ShSe-DRUM-1-L35-90-UNV-STD	ShSe-DRUM-2-L35-90-UNV-STD	ShSe-DRUM-3-L35-90-UNV-STD
Lumens	4000.3 Lm	4989.9 Lm	6557.4 Lm
Input Watts	28.2 W	45.3 W	60.4 W
Efficacy	141.9 Lm/W	110.2 Lm/W	108.6 Lm/W
CCT	3500K	3500K	3500K
SC (0/90/45)	1.62 / 1.62 / 1.62	1.62 / 1.62 / 1.62	1.62 / 1.62 / 1.62

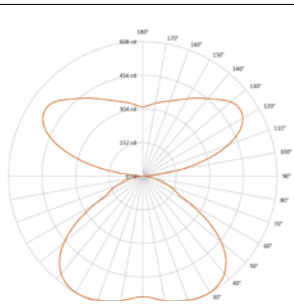

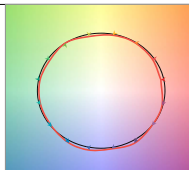

Color Vector Graphic TM-30-15

R ₁	91
R ₂	98
R ₉	67

55% up 45% down

DRUM			
Light Level-CCT-CRI	Delivered	Power	Efficacy
	LUMENS	WATTS	LPW
1-L30-80	3960	29	138
1-L35-80	4000	29	142
1-L40-80	4176	29	148
1-L30-90	3014	29	109
1-L35-90	3328	29	121
1-L40-90	3347	29	122
2-L30-80	5938	46	131
2-L35-80	5998	46	132
2-L40-80	6262	46	138
2-L30-90	4519	46	100
2-L35-90	4990	46	110
2-L40-90	5018	46	110
3-L30-80	7803	61	129
3-L35-80	7882	61	130
3-L40-80	8228	61	136
3-L30-90	5939	61	98
3-L35-90	6557	61	108
3-L40-90	6595	61	109

Color block denotes highest and lowest lumen levels

Color block denotes highest and lowest LPW levels

Cleaning recommendations and Guidelines for Light Engine

Removing Dust from Optical Panels:

Use the following recommendations:

- BEST:** Using aerosol dusting spray, gently blow dust from top of optical panels.
- GOOD:** Using CLEAN Swiffer, VERY gently brush dust from top of optical panels.
- NO:** DO NOT rub dust from top of fixture with cleaning cloth or dirty duster.

Cleaning Optical Panels:

Use the following recommendations:

- A:** Blend 4 parts warm water and 1 part DAWN dish soap.
- B:** Dampen CLEAN micro fiber cloth (or equivalent) with cleaning solution and gently wipe optical panel in single direction.
- C:** Gently dry optical panels with micro-fiber cloth (or equivalent).

Light Level	CCT	UGR [CIE 190:2010] ⁽¹⁾ (4H, 8H; Reflectance: 70% Ceiling, 50% Wall, 20% Ref. Plane)		MAX INTENSITY [45-90 DEG FROM NADIR] (2) (Candela CD)		MAX LUMINANCE [45-90 DEG FROM NADIR] (2) (CD/M ²)	
		80CRI	90CRI	80CRI	90CRI	80CRI	90CRI
1	3500K	12.2	11.6	511	425	2271	1889
2	3500K	13.6	13	766	637	3405	2833
3	3500K	14.5	13.9	1006	837	4475	3723

Notes: (1) For other UGR data for room or reflective ceiling plans please see technical data on website. (2) For other CCT please see technical data on website.

Acoustic Analysis Reverberation Decrease

Reverberation Time example. Acoustic test reports available by request.

RT60 : Light Fixtures without sound absorption

Frequency (Hz)						Avg
125	250	500	1000	2000	4000	250-2k
0.76	0.97	1.15	1.11	0.91	0.85	1.04

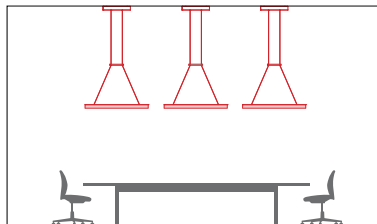

6 fixture comparison

Reverberation: prolongation of a sound; resonance.
 Reverberation Time (RT60): Reverberation time is a measure of the time required for the sound to decay. The time it takes for the sound pressure level to reduce by 60 dB.

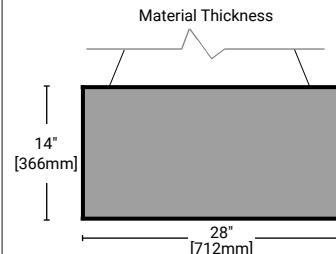

Acoustic panel thickness is 1.49" thick. Each of the 4 panel sizes are 28"L x 14"H x 1.49"D.

RT60 : Light Fixtures with sound absorption

Frequency (Hz)						Avg
125	250	500	1000	2000	4000	250-2k
0.72	0.86	0.93	0.79	0.68	0.65	0.82

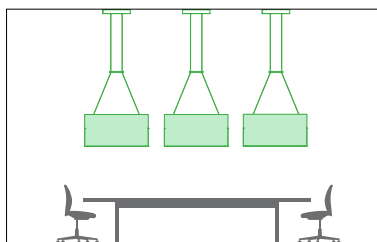

Reverberation Time

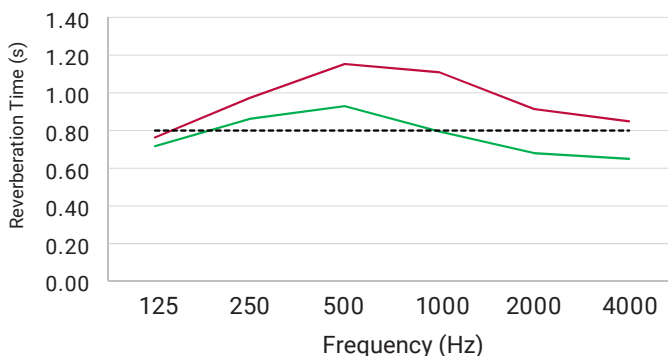

% Improvement in Reverberation (RT60)

Frequency (Hz)						Avg
125	250	500	1000	2000	4000	250-2k
6%	11%	19%	28%	26%	23%	21%

Ex. 21% Reverberation decrease (RT60) using 6 Shaper Sense Box fixtures.

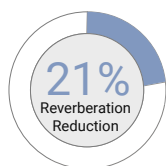

RT60 GOAL (typical. office) **0.8**

Acoustic Material Maintenance: Cleaning and Health Features



- A health benefit to using FilzFelt materials, is the ability for the material to be steam cleaned up to 200 deg F (93.3 deg C). This protects the space by ensuring that bacteria and viruses don't live on these surfaces, but allows the material to meet the needs of spaces today.
- The acoustic sound absorption substrate material used in Shaper Sense products are cleanable by bleach and other disinfectants. This makes the materials suitable for clean environments.

	Felt	Acoustic Substrate
General Cleaning	Vacuum occasionally to remove general air-borne debris. Spot clean with a mild enzyme-based detergent (such as Tide Free) and water solution. Avoid aggressive rubbing as this can continue the felting process and change the surface appearance of the felt.	Vacuum occasionally to remove general air-borne debris. Spot clean with a mild soap (such as Dawn) and water solution.
Deep Cleaning	Professionally steam clean	Wipe with 10:1 water-to-household bleach solution*.

Connected Control (Optional)

WaveLinX (SWPD1) Wireless Sensor and LumaWatt Pro (LWIPD1) Ordering Information.

Product Family	Description
WTA = WaveLinX Wireless Sensor	<p>WTA =</p> <ul style="list-style-type: none"> WaveLinX wireless sensor kit for daylight dimming, PIR motion sensing, and optional RLTS - Real Time Location Services, use with 0-10V driver (Refer to WaveLinX system specifications and guides for details). Field installed accessory WaveLinX Sensor Kit. Passive Infrared, Dimming Daylight Harvesting (Closed Loop), and for 144 sq ft coverage. The WTA WaveLinX kit includes control module that mounts on the luminaire electrical junction box via 1/2" knock-out, and tilemount sensor with direct-mount spring clips or for octagon ceiling box with included mounting bracket. (Field mount kit ordered and installed separately)

WaveLinX

The WaveLinX Tilemount sensor option is an integral part of the WaveLinX Wireless Connected Lighting System. It offers 3 amp relay control and continuous 0-10V dimming of Shaper Sense luminaires. The tilemount sensor provides daylight dimming and control for a single luminaire or can be daisy chained for group luminaire control. The sensor's control module allows simple electrical junction box mounting via a 1/2" knockout or direct connection to the junction box attached to the Shaper luminaire. The WaveLinX Tilemount sensor operates on a wireless mesh network based on IEEE 802.15.4 standards and is controlled by a WaveLinX Wireless Area Controller.

Sensor Mounting and Coverage

Daylight Harvesting - Recommended mounting

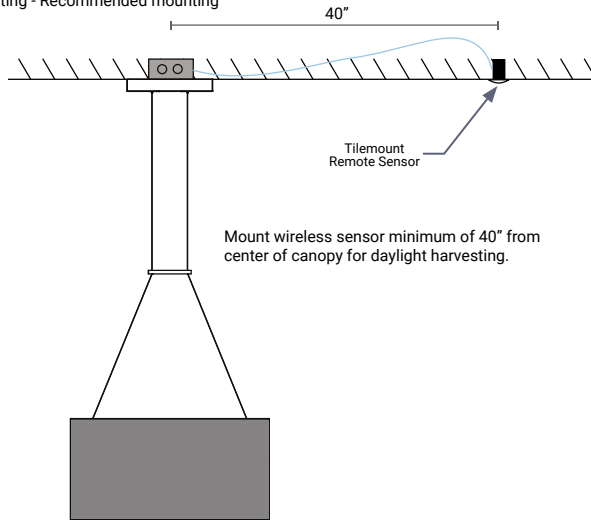

Occupancy Detection - Coverage

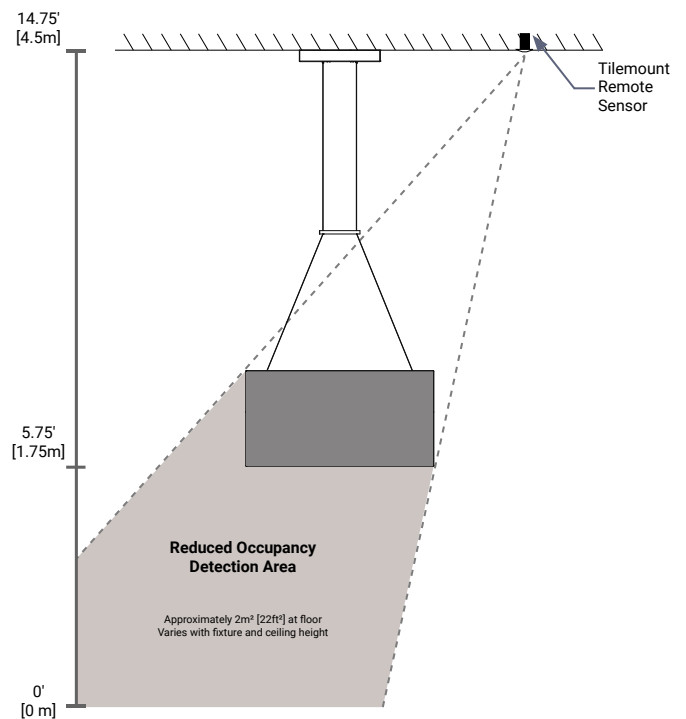

Wireless Sensor Example Layout

Daisy-chain switching control and 0-10V dimming up to 360W of luminaires per sensor

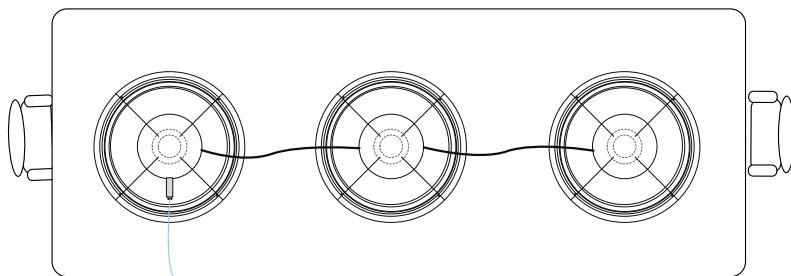
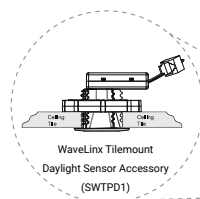

54" [1372 mm] plenum rated sensor cable