

Project		Catalog #		Type	
Prepared by		Notes		Date	

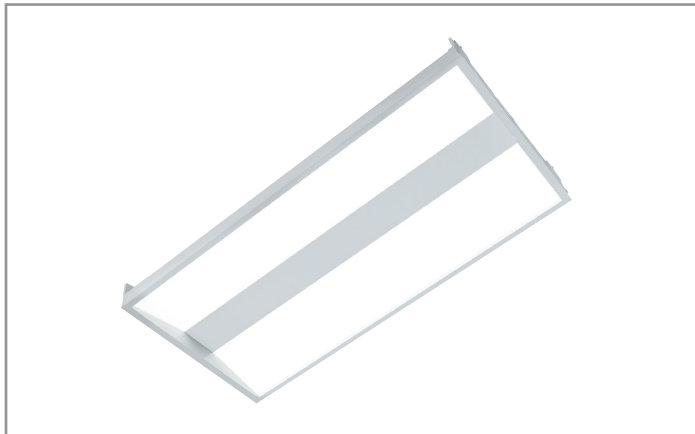

# Metalux

## Encounter 12EN LED

1' x 2' Troffer LED Module  
Specification Grade Troffer

### Typical Applications

- Commercial Office Spaces • Schools • Hospitals • Retail
- Other Indoor Ambient Applications

### Interactive Menu

- Order Information [page 2](#)
- Photometric Data [page 3](#)
- Control Solutions [page 4](#)
- Product Warranty

### Product Certification



### Product Features



### Top Product Features

- Available in 1' x 2', 1' x 4', 2' x 2' and 2' x 4' recessed versions
- Leverages our patented WaveStream Technology with AccuAim™ optics
- Four CCT options: 3000K, 3500K, 4000K, and 5000K at 80CRI or 90 CRI
- White tuning solutions available, either 3000K - 5000K or 2700K - 6500K
- Efficacy up to 143 lumens per watt
- Options to meet Buy American and other domestic preference requirements

### Dimensional and Mounting Details

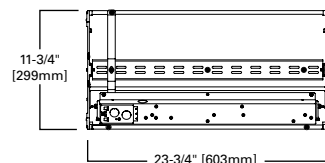
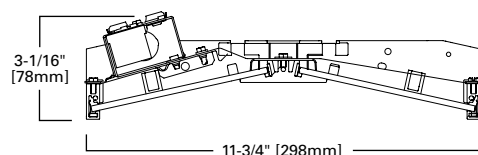

### Ceiling Compatibility

G Grid/Lay-in Standard	G or T 9/16\" or 15/16\" Slot Grid	F Drywall Frame Kit	Ceiling Type	Trim Type
			Exposed Grid	G
			Concealed T	G or T
			Slot Grid	G or T
			Flange	*

#### Notes:

\*See Drywall Frame Kit Accessory in Ordering Information section.

\*\*Fixture construction is suitable for use in Air-handling and plenum rated spaces in accordance with Section 300.22 (C) of the National Electrical Code, Section 4.3.11.2.6.5 of NFPA 90A and Section 602.2.1.4 of ICC.

## Order Information

SAMPLE ORDER NUMBER: **12EN-LD2-13-UNV-L835-CD1-WPS-U**

Domestic Preferences	Rating	Series	Air	Lamp Type	MTO Lumen Output	Voltage	Emergency Options
Domestic Preferences <sup>(1)</sup>	Rating	Series	Air	Lamp Type	MTO Lumen Output	Voltage <sup>(5)</sup>	Emergency Options
<b>[Blank]</b> =Standard <b>BAA</b> =Buy American Act <b>TAA</b> =Trade Agreements Act	<b>[Blank]</b> =Standard <b>ATW-SW4</b> =Chicago Rated <sup>(2)</sup>	<b>12EN</b> =1' x 2' Encounter Series	<b>[Blank]</b> =Standard <b>A=Air</b> (Vented) <sup>(3)</sup>	<b>LD2</b> =LED 2.0	<b>08</b> =800 Lumens <sup>(4)</sup> <b>13</b> =1300 Lumens <sup>(4)</sup> <b>17</b> =1700 Lumens <b>23</b> =2300 Lumens <b>27</b> =2700 Lumens <b>31</b> =3100 Lumens <b>35</b> =3500 Lumens <b>39</b> =3900 Lumens	<b>UNV</b> =Universal Voltage 120-277 <b>347V</b> =347 Volt <sup>(6)</sup> <b>120V</b> =120 Volt <sup>(7)</sup> <b>277V</b> =277 Volt <sup>(7)</sup>	<b>EL7W</b> =7-watt 120V-277V emergency battery pack <sup>(8)</sup> <b>GTR2</b> =Generator Transfer Relay <sup>(9),(10)</sup> <b>ETRD</b> =Emergency Transfer Relay with dimming control <sup>(9)</sup>
<b>Notes</b> (1) Only product configurations with these designated prefixes are built to be compliant with the Buy American Act of 1933 (BAA) or Trade Agreements Act of 1979 (TAA), respectively. Please refer to <a href="#">DOMESTIC_PREFERENCES</a> website for more information. Components shipped separately may be separately analyzed under domestic preference requirements.	<b>Notes</b> (2) Chicago rated version does not allow for row mounting.		<b>Notes</b> (3) Air version is vented but does not meet air handling requirements; a 6% reduction in delivered lumens is experienced with this option.		<b>Notes</b> (4) White tuning not available with 800 and 1300 lumen options.	<b>Notes</b> (5) Products also available in non-US voltages and frequencies for international markets. (6) 347V emergency option not available. (7) Must specify voltage as 120V or 277V when ordering GTR2 option.	<b>Notes</b> (8) With integral test switch/indicator/laser test. For approximate delivered lumens multiply the lumens per watt of the desired fixture by the wattage of the emergency battery pack (100 lm/W x 7=700 lumens). IES-format photometry for luminaire under emergency operation available. Battery option increases total height by 1 inch. (9) Used to bypass local control during outage. Must be used in conjunction with UL 1008 device (provided by others). GTR2 option includes 2 relays on fixtures with dimming drivers. ETRD option only requires one relay when used on a dimming fixture. (10) Must specify voltage as 120V or 277V when ordering GTR2 option.

CCT	Flex	Driver Type	Number of Drivers
CCT	Flex	Driver Type	Number of Drivers
<b>L830</b> =3000K <b>L835</b> =3500K <b>L840</b> =4000K <b>L850</b> =5000K <b>L83050</b> =80CRI 3000K-5000K White Tuning <sup>(11)</sup> <b>L93050</b> =90CRI 3000K-5000K White Tuning <sup>(11)</sup> <b>L82765</b> =80CRI 2700K-6500K White Tuning <sup>(11)</sup> <b>L92765</b> =90CRI 2700K-6500K White Tuning <sup>(11)</sup>	<b>A3/8-4/18GDIM</b> =3/8" Flex with 0-10V Dimming Leads Multiple other configurations available. See below for details. <b>A3/8-5/18GDIM</b> =Flex with 0-10V Dimming leads and Blue for alternate wiring. See below for details.	<b>CD</b> =0-10V Driver (1%-100% Dimming) <b>SR</b> =Sensor-ready Driver (1%-100% Dimming) <b>5LTD</b> =DALI Driver (5%-100% Dimming) <sup>(12)</sup> <b>5LTHD</b> =DALI Driver (1%-100% Dimming) <b>SD</b> =Step Dimming Driver (50% or 100% Dimming) <sup>(12)</sup> <b>LH</b> =Lutron HiLume (LDE1 series) 1%-100% EcoSystem Driver with Soft-on Fade to Black dimming <sup>(7)</sup> <b>W2A</b> =White Tuning, 2ch, Intensity and CCT Control <sup>(13)</sup>	1=1 Driver
<b>Notes</b> (11) White tuning provides correlated color temperatures (CCT) between 3000K (warm) to 5000K (cool) or 2700K (warm) to 6500K (cool). Must be used in conjunction with W2A driver only. Must be used with two (2) 10V dimming control channels, 1 color, 1 intensity.	<b>Flexible Metal Conduit Options</b> Flex options available for 0-10V dimming control, DALI dimming control, emergency and night light functions. 72-inch factory-installed and pre-wired to driver, fitted to luminaire housing access plate with 90° enclosed FMC connector. Not all options may be combined and installation ratings vary by type. <b>A3/8-4/18GDIM series notes:</b> Factory installed dimming option 3/8" flexible metal conduit with 2-#18 power and ground wires and 2-#18 UL-listed jacketed 0-10V +/- control wires. Meets UL 66, 83, 1479, 1569, 1581, 2556, NEC® 250.118, 300.22(C), 392, 396, 330, 501, 502, 503, 530, 504, 505, 518, 520, 530, 645, 72; Federal Specification A-A-59544 (formerly J-C-308); all applicable OSHA and HUD Requirements. UL Classified 1-, 2-, and 3-hour through penetration with applicable fire stop product (not included). May be surface mounted, fished and/or embedded in plaster. Cable tray and approved raceway rated, install per NEC®; Environmental Air-Handling Space Installation per NEC® 300.22(C).	<b>Notes</b> (12) 800, 1300, 1700, 2300, 2700 and 3100 lumen packages not available with Step-Dim (SD) and DALI (5LTD) driver option. (13) White tuning provides correlated color temperatures (CCT) between 3000K (warm) to 5000K (cool) or 2700K (warm) to 6500K (cool). Must be used in conjunction with W2A driver only. Must be used with two (2) 10V dimming control channels, 1 color, 1 intensity. Integrated options must be used in conjunction with the associated system and may not be compatible with other options or accessories. Please refer to the following: (E) Consult Fifth Light system pages for additional details and compatibility. (F) Consult Marketplace Options - Lutron system pages for additional details and compatibility. Compatible only with driver series shown, and may require two or more drivers. Requires field commissioning to operate or dim. Contact Lutron at <a href="http://www.lutron.com">www.lutron.com</a> .	

Integrated Sensing Systems	Packaging	Accessories
Integrated Sensing Systems <sup>(14)</sup>	Packaging	Accessories (order separately) <sup>(17)</sup>
<b>[Blank]</b> =No Sensor <b>WLS (formerly WAB)</b> =WaveLinX LITE Wireless Sensor, Occupancy w/ photocell, Independent & Networked <sup>(16),(B)</sup> <b>WPS (formerly WAA)</b> =WaveLinX PRO Wireless Sensor, Occupancy w/ photocell, Networked <sup>(15),(A)</sup> <b>WLN</b> =WaveLinX LITE Wireless Control Node, without sensor <sup>(16),(B)</sup> <b>WPN</b> =WaveLinX PRO Wireless Control Node, without sensor <sup>(15),(A)</sup>	<b>U</b> =Unit Pack <b>PALC</b> =Job Pack, in carton	<b>T3A END E.Q. BRACKET PARTS BAG</b> (Standard with fixture) <b>DF-12W-U</b> =1' x 2' Drywall Frame Kit
<b>Notes</b> (14) Integrated sensor options not available with Air version. (15) WPS sensor and WPN node to be used with CD or W2A driver. (16) WAB sensor and WLN node to be used with CD driver. Integrated options must be used in conjunction with the associated system and may not be compatible with other options or accessories. Please refer to the following: (A) Consult WaveLinX system pages for additional details and compatibility. (B) Consult WaveLinX Lite system pages for additional details and compatibility.		<b>Notes</b> (17) Accessories sold separately will be separately analyzed under domestic preference requirements. Consult factory for further information.

## Product Specifications

### Construction

- Shallow 3-1/16" deep housing extruded aluminum frame
- Injected molded composite end plates
- End plates screws for strength, rigidity and gap eliminations
- End plates accessory grid-lock feature adds safety
- Four auxiliary fixture end suspension points
- Large access plate for supply connection

### Controls

- 0-10V dimming to 1% standard
- Integrated WaveLinX options provide wireless individual fixture control and enable code compliance, increased energy savings, grouping of fixtures, and connection to WaveLinX control systems
- DALI 2.0, Lutron, and step-dimming available

### Electrical

- LED's available in 3000K, 3500K, or 4000K at 80 CRI or 90 CRI minimum
- Color accuracy  $\leq 3$ -Step MacAdam ellipse (SDCM)
- TM21 life at 60,000 hours up to L92 and calculated L70 exceeds 130,000 hrs.
- Drivers available in 120-277V and 347V
- Tunable white options available with Cooper Lighting's VividTune

### Emergency Battery Pack Options

- Optional 120V-277V integral emergency battery pack available in 7W or 14W
- 90-minute backup period for code compliance
- Test switch with laser pointer allows safe testing from floor
- Patented EZ Key prevents accidental discharge during construction

### Driver Access

- Drivers can be accessed via plenum

### Finish

- High reflectance baked matte white enamel finish

### Optics

- Precision formed optical assembly
- Positively retained high optical grade acrylic lenses
- WaveStream technology provides a visually comfortable fully luminous surface

### Compliance

- Components are UL recognized
- cULus Damp Location listed for 25C ambient indoor environments
- Complies with IESNA LM-79 and LM-80 standards

### Warranty

- Five year limited warranty standard. Optional ten year limited warranty available.

## Photometric Data

[View IES files](#)

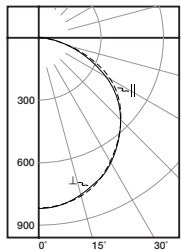

### 12EN-LD2-23-UNV-L835-CD1-U

Electronic Driver  
 Linear LED 3500K  
 Spacing criterion: (H) 1.3 x mounting height,  
 (L) 1.3 x mounting height  
 Lumens: 2395  
 Input Watts: 20.5W  
 Efficacy: 116.8 lm/W  
 Test Report: 12EN-LD2-23-UNV-L835-CD1-U.IES

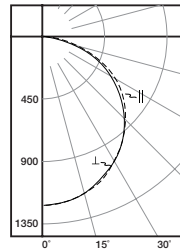

### 12EN-LD2-35-UNV-L835-CD1-U

Electronic Driver  
 Linear LED 3500K  
 Spacing criterion: (H) 1.3 x mounting height,  
 (L) 1.3 x mounting height  
 Lumens: 3560  
 Input Watts: 31.5W  
 Efficacy: 113.00 lm/W  
 Test Report: 12EN-LD2-35-UNV-L835-CD1-U.IES

## Energy and Performance Data

Stock or MTO	Catalog Logic	Delivered Lumens	Watts	Efficacy (LPW)
MTO	12EN-LD2-08-UNV-L835-CD1-U	832	9.9	84
MTO	12EN-LD2-13-UNV-L835-CD1-U	1345	12.2	110
MTO	12EN-LD2-17-UNV-L835-CD1-U	1772	15.7	113
MTO	12EN-LD2-23-UNV-L835-CD1-U	2395	20.5	117
MTO	12EN-LD2-27-UNV-L835-CD1-U	2790	24.0	116
MTO	12EN-LD2-31-UNV-L835-CD1-U	3179	27.7	115
MTO	12EN-LD2-35-UNV-L835-CD1-U	3560	31.4	113
MTO	12EN-LD2-39-UNV-L835-CD1-U	3975	35.4	112

### Lumen Maintenance

Ambient Temperature	TM-21 Lumen Maintenance (60,000 hours) <sup>(1)</sup>	Theoretical L70 (Hours) <sup>(2)</sup>
25°C	> 92%	> 130,000

Notes: (1) Supported by IES TM-21 standards. (2) Theoretical values represent estimations commonly used; however, refer to the IES position on LED Product Lifetime Prediction, IES PS-10-18, that explains proper use of IES TM-21 and LM-80.

### Lumen Calculator

CCT Multiplier	80 CRI	90 CRI
3000K	0.970	0.835
3500K	1.000	0.864
4000K	1.020	0.901
5000K	1.110	0.955

### Shipping Data

Catalog No.	Weight (lbs)	Units per Pallet 49"L x 52"W x 55"H
12EN-LD2-13	8	27

## Control Solutions

- WaveLinX LITE wireless
- WaveLinX PRO wireless
- WaveLinX CAT wired
- WaveLinX Wired



The Encounter with WaveLinX offers no-hassle lighting control with multiple luminaire level control solutions.



**WaveLinX PRO** is a wireless lighting control solution, for connected spaces, that significantly reduces a building's energy consumption. From a single floor to an entire campus, WaveLinX PRO connects more than lighting assets; it shares aggregated sensor data with the WaveLinX CORE platform and other building systems, so building owners can improve operations, spaces environment, and tenants' experience. WaveLinX PRO offers a rich portfolio of wireless devices, WaveLinX PRO-enabled luminaires, and an intuitive WaveLinX mobile app for office, education, warehouse, and parking garage applications.



**WaveLinX LITE** is a cost effective, wireless digital lighting control solution, with out-of-the-box functionality, that saves energy and meets code. It's designed for applications that require occupancy-based, daylighting, or manual light control. Customize installations for office, education, warehouse and parking garages using the secure, simple mobile app.

### Integrated Sensor Coverage Pattern

TOP VIEW:

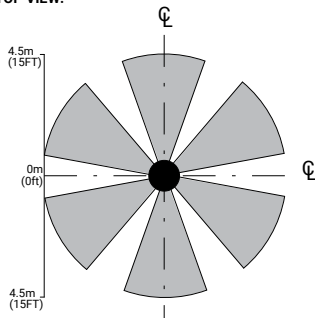

SIDE VIEW:

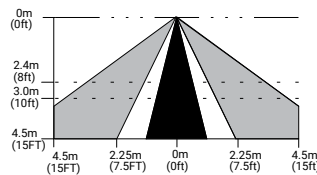

**Note:** Installation of integrated sensors within 3-ft (1m) of HVAC air vents is not recommended. The pattern shown is intended solely as a general guide and is not to scale.

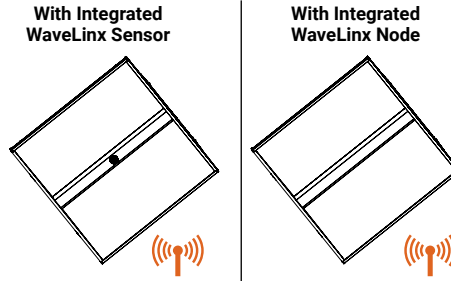

Add a hidden WaveLinX sensor node (WPN, WLN) to your space lighting design!

**Allows to:**

- Keeps luminaire aesthetics
- Connect fixtures without the realestate to include sensor option such as downlights
- Connect sealed fixtures without a standard sensor option such as products for clinical space.

### Integrated Controls Options

Option	Out of the Box Functionality	Luminaire Level Lighting Control (LLC)	Automatic Dimming Photocell	Occupancy Sensing	CCT Control
WLS	X	X	X	X	
WLN		X			
WPS		X	X	X	X
WPN		X			X

**Note:** WaveLinX utilizes scenes to allow users to change an area's fixtures Correlated Color Temperature (CCT) and intensity using commissioned manual wireless wallstation scene control. To enable CCT adjustments through WaveLinX, include WPS or WPN devices in addition to VividTune or BioUp technologies for integrated fixture control.

## Systems comparison chart

Cooper Lighting Solutions provides many lighting system solutions designed to satisfy code requirements and meet the unique needs of any project.



**Luminaire with standalone sensor**



**Standalone Spaces WaveLinX LITE**



**Standalone Spaces WaveLinX CAT**



**Networked Spaces WaveLinX PRO**



**Enterprise WaveLinX CORE**

	Luminaire with standalone sensor	Standalone Spaces WaveLinX LITE	Standalone Spaces WaveLinX CAT	Networked Spaces WaveLinX PRO	Enterprise WaveLinX CORE
<b>Occupancy</b>	Yes	Yes	Yes	Yes	Yes
<b>Daylighting</b>	Yes	Yes	Yes	Yes	Yes
<b>Wallstations</b>	-	Yes	Yes	Yes	Yes
<b>Gateways</b>	-	-	-	1 WAC	300 WACs
<b>Devices (MAX)</b>	-	40 per Area (1120 per space)	40 per Area	200 per WAC2	32,500 per CORE Enterprise
<b>Software</b>	-	WaveLinX LITE Mobile App	WaveLinX CAT Mobile App	WaveLinX Mobile App	CORE
<b>Areas</b>	-	28 per Space	Unlimited	50 per WAC2	up to 3,000
<b>Zones</b>	-	16 per Area	16 per Area	16 per Area	up to 9,000
<b>Scheduling</b>	-	-	-	Local	Global
<b>VividTune™</b>	-	-	-	Yes	Yes
<b>Plug-Load Control</b>	-	Yes	Yes	Yes	Yes
<b>Low-Voltage Power</b>	-	-	Yes	Yes	Yes
<b>Integration</b>	-	-	-	-	BACnet, API
<b>Dashboards</b>	-	-	-	-	Energy, Occupancy
<b>Configuration</b>	-	Installer	Installer	Technician	Technician / IT



### 12EN LED with VividTune Tunable White

VividTune tunable white luminaires from Cooper Lighting Solutions deliver high-quality light in a broad range of continuously variable color temperatures and intensities. Create a dynamic environment by adjusting the ambient light warmer or cooler to influence mood, support the task at hand, or create a dramatic ambience. The ability to control correlated color temperature and intensity separately using simple controls is the next evolution of LED lighting for the commercial, educational, healthcare and hospitality space. The unparalleled flexibility and number of available lighting environments enable users to find the right light with tunable white.

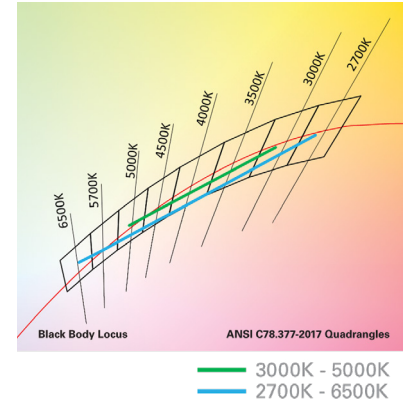

### Performance Data\*

Tunable White - Lumen Adjustment Factors (example only)				
CCT	3000K-5000K		2700K-6500K	
	80 CRI	90 CRI	80 CRI	90 CRI
2700K	-	-	0.871	0.719
3000K	0.943	0.788	0.879	0.742
3500K	0.958	0.806	0.908	0.759
4000K	0.963	0.837	0.895	0.793
4500K	0.976	0.842	0.922	0.787
5000K	0.977	0.846	0.920	0.808
6500K	-	-	0.925	0.828

1' x 2' Encounter LED - Example of Approximate Lumen Calculation			
	Standard Catalog #	VividTune 80 CRI Catalog #	VividTune 90 CRI Catalog #
CCT Setting	12EN-LD2-23-UNV-L835-CD1-U	12EN-LD2-23-UNV-L83050-W2A1-U	12EN-LD2-23-UNV-L93050-W2A1-U
3000K	-	2259	1886
3500K	2395	2296	1930
4000K	-	2305	2005
4500K	-	2336	2016
5000K	-	2339	2025

### Controlling VividTune Tunable White

VividTune luminaires make tunable white more accessible by using simple and familiar controls. From wall dimmers to wireless controls, VividTune tunable white luminaires are compatible with industry standard 0-10V dimming controls. A single 0-10V dimming input is used to control intensity (brightness) while a second 0-10V dimming input is used to adjust CCT. For suggested control configurations, [click here](#) for tunable white application guides.

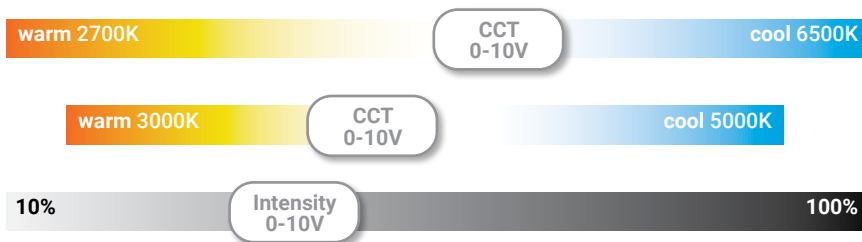

### Example of Lumen Adjustment Calculation

12EN-LD2-23-UNV-L83050-W2A1-U at 80 CRI tuned to 3500K

$$\text{Adjusted Lumen} = \text{published } lm \times \text{adjusted } lm \text{ factor}$$

$$\text{Adjusted Lumen} = 2395 * 0.958$$

$$\text{Adjusted Lumen} = 2296 \text{ lm}$$

\* Lumen adjustment factors are for reference and may be different for each product selected. Refer to IES files for actual performance data on each.