

Project		Catalog #		Type	
Prepared by		Notes		Date	



Portfolio

LDS4C | EU4C | 4LBS

4" round, new construction
shallow downlight
250-4000 Lumens

Typical Applications

Office • Education • Healthcare • Hospitality • Retail •
Code-Compliance Areas • Sports Venues

Interactive Menu

- Order Information [page 2](#)
- Product Specifications [page 3](#)
- Energy Data [page 4](#)
- Photometric Data [page 5](#)
- Connected System [page 6](#)
- Product Warranty



Top Product Features

- 250-4000 lumens; Offered in 90 and 97 CRI; ENERGY STAR® qualified
- Optional snap in driver for ease of replacement; Die-cast or anodized aluminum reflectors
- Standard 0-10V driver dims to 1%; Easy disconnect for LED engine replacement and installation
- 2400K, 2700K, 3000K, 3500K, 4000K, 5000K; D2W™ option from 3000K to 1850K
- Available W2N tunable white CCT range 2700K to 6500K or 2000K to 5000K
- Options to meet Trade Agreements Act requirements

Dimensional and Mounting Details

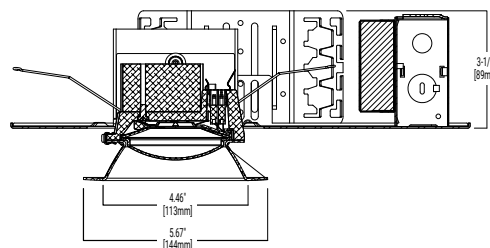
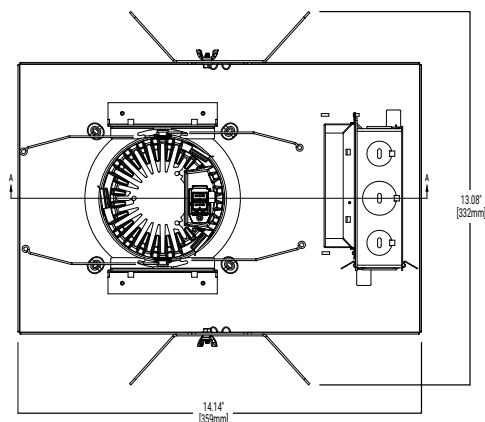

[CLICK HERE](#)
dimension information

Single Line Order Information

SAMPLE ORDER NUMBER: **LDS4C109035D010CS1MW = LDS4C10D010 + EU4C10209035 + 4LBS1MW**
(all components in multiple packages in same shipment)

Invoice will indicate separate fixture components (housing, trim, module) which will ship complete from a single CLS facility in separate cartons.
 To receive separate components (housing, trim, module) shipment, click on the "Multi-Line Ordering Information Option" button to the right.



Housing	Lumen ⁽¹⁾	Color Control	CCT ⁽²⁰⁾
LDS4C =LED Downlight 4" Nominal Aperture LDS4CCP =LED Downlight 4" Nominal Aperture, Chicago Plenum For TAA use Multi-line Ordering	02 = 250 Lumens, IC rated 05 = 500 Lumens, IC rated 08 = 800 Lumens, IC rated 10 = 1000 Lumens 10IC = 1000 Lumens, IC rated 15 = 1500 Lumens 15IC = 1500 Lumens, IC rated	20 = 2000 Lumens 25 = 2500 Lumens 30 = 3000 Lumens ⁽¹⁰⁾ 35 = 3500 Lumens ⁽¹⁰⁾ 40 = 4000 Lumens ⁽¹⁰⁾	90=90 CRI Minimum 97=97 CRI Minimum 90 CRI 97 CRI 24=2400K 27=2700K 30=3000K 35=3500K 40=4000K 50=5000K 27=2700K 30=3000K

Voltage	Driver	Driver Options	Hanger Bars
Blank = 120-277V 1 = 120V Used only with remote driver 3500 and above 2 = 277V Used only with remote driver 3500 and above 3 = 347V (D010 driver 800-4000 lumens) 250 & 500 include step down transformer	D010 = 0-10V 1% dimming 500-4000 lumens D010TR =0-10V or (120V) phase cut 1% dimming 250-4000 lumens DE010 = 0-10V linear 0.1% dimming 500-4000 lumens D5LT = DALI T6 Logarithmic 0.1% Dimming 500-4000 lumens DMX = DMX/RDM Logarithmic 0.1% Dimming 800-4000 lumens ⁽¹⁴⁾ DMXC5 = DMX/RDM Logarithmic 0.1% Dimming with RJ45 connection 800-4000 lumens ⁽¹⁴⁾ DLE = Lutron Ecosystem dimming 1-100% 800-4000 lumens DLV = Low voltage dimming 1-100% for use with DLVP system, 800-3000 lumens (not offered with plug in driver) ⁽³⁾	Blank = Integral driver RC100 =Remote 100ft ^{(3) (30)} RC75 =Remote 75ft ^{(3) (30)} RC50 =Remote 50ft ^{(3) (30)} RC25 =Remote 25ft ⁽³⁾ RC15 =Remote 15ft ⁽³⁾ RC5 =Remote 5ft ⁽³⁾ RC2 =Remote 2ft ⁽³⁾ PD = Plug in Driver ⁽²²⁾	Blank = Without hanger bars B26 = C-channel Bar Hanger, 26" Long, Pair

Trim Distribution	Trim Flange	Trim Finish	Options ^{(3) (14) (23)}
S =Shallow, Spun Aluminum PS =Non-Conductive Shallow (dead front), white ^{(11) (12)} CS =Cast Shallow, Die Cast Aluminum	0 =White Polymer Trim Ring 1 =Self-flanged ⁽¹³⁾ 2 =White Painted Self-flanged 4 =Knife edge rimless use with die cast only ^{(6) (6)}	LI =Specular Clear ⁽⁹⁾ H =Semi-Specular Clear ⁽⁹⁾ WMH =Warm Haze ⁽⁹⁾ WH =Wheat ⁽⁹⁾ GPH =Graphite Haze ⁽⁹⁾ B =Specular Black ⁽⁹⁾ MW =Matte White (Antimicrobial) MB =Matte Black ⁽⁸⁾ MMS =Matte Metallic Silver ⁽⁸⁾	EMB0D6ST =Bodine® 6W Self Test Emergency Module with Remote Test Switch WPN = WaveLinX PRO Wireless Node without sensor ^{(19) (24)} WLN = WaveLinX LITE Wireless Node without sensor ^{(25) (24)}

Accessories (Order Separately) ⁽²⁰⁾			
TRM4P =White Metal Trim Ring ⁽²⁾ LGSKT4IP66 =IP66 Gasket Kit PRR4 =Rimless Plaster Ring ⁽⁴⁾ RKP4 =Knife Edge Plaster Ring ⁽⁵⁾	RPM4MW =Rimless Millwork Ring, Matte White ⁽²⁾ RPM4MB =Rimless Millwork Ring, Matte Black ⁽²⁾ RKM4MW =Knife Edge Millwork Ring, Matte White ⁽⁵⁾ RKM4MB =Knife Edge Millwork Ring, Matte Black ⁽⁵⁾ HSA4 =Slope Adapter for 4" Aperture Housings, Specify Slope ⁽²⁴⁾	Bar Hangers HB50 =C-channel Bar Hanger, 50" Long, Pair RMB22 =Wood Joist Bar Hanger, 22" Long, Pair	Connected Lighting Systems ^{(3) (15)} WPST = Field installed WaveLinX PRO Sensor Kit ⁽¹⁷⁾ WLST = Field installed WaveLinX LITE Sensor Kit ⁽¹⁸⁾

- Notes:**
- Nominal Lumens will vary depending on selected color, CRI, driver and reflector finish. [Reference Multiplier tables.](#)
 - Order trim with polymer trim ring.
 - Not available with Chicago Plenum.
 - ULUS listed only
 - Order die cast trim with flange type 4
 - Requires knife edge accessory ring.
 - Available only on CS distributions.
 - Not available on PS or CS distributions.
 - Product is marked spacing. [Reference table on page 3.](#)
 - PS available in self-flanged MW finish only.
 - Offered up to 2000 lumens
 - Flange is the same finish as the reflector
 - DMX fixtures default to full on upon loss of DMX signal.
 - Refer to system specifications for additional information, features, and benefits. Use with 0-10V driver.
 - Non-IC
 - WLST = WaveLinX LITE tilemount sensor kit for daylight dimming, PIR motion sensing, use with D010 only (Refer to WaveLinX LITE system specifications)
 - WPST = WaveLinX PRO wireless sensor kit for daylight dimming. Offered with shallow (S) spun trim. PIR motion sensing, and optional RLTS - Real Time Location Services, use with 0-10V only.
 - WPN = WaveLinX PRO wireless node provides luminaire level control with scene and zone configuration without an integrated sensor; Connects wirelessly with daylight dimming sensor and PIR motion sensor if desired. Use with D010 or DE010 drivers only.
 - Accessories sold separately will be separately analyzed under domestic preference requirements. Consult factory for further information.
 - Not available with DLVP
 - 120V-277V
 - Not recommended for use with Wall Wash
 - WLN = WaveLinX LITE wireless node provides luminaire level control with scene and zone configuration without an integrated sensor; Connects wirelessly with daylight dimming sensor and PIR motion sensor if desired. Use with D010 or DE010 drivers only
 - Not compatible with 347V or Chicago plenum.
 - Not available with Lutron drivers

Product Specifications

Lower Shielding Reflector

- Painted die cast aluminum, spun aluminum or nonconductive injection molded lower reflector with a lensed upper optical chamber providing superior lumen output with minimal source brightness
- Spun reflectors are offered in all Portfolio anodized finishes
- Reflector is retained with two torsion springs holding the flange tight to the finished ceiling surface
- Plaster lathing ring accessory offered for flush reflector transition

Plaster Frame

- Galvanized steel plaster frame designed for ceiling thickness from 1/2 to 1-1/4-inch

Universal Mounting Bracket

- Accepts 1/2" Electric Metallic Tube (EMT), C-channel and bar hangers
- Adjusts 5" vertically from above and below the ceiling

Junction box

- Four 1/2" and two 3/4" trade size pry outs positioned to allow straight conduit runs
- Lever connectors for simple push in wiring
- Listed for (4) #12 AWG (two in, two out) 90°C conductors and feed thru branch wiring for type IC and Plug in drivers for 120/277V only. For all other cases (8) #12 AWG (four in, four out) 90°C conductors and feed thru branch wiring for 120/277V only

Thermal

- Aluminum heat sink conducts heat away from the LED module for improved performance and longer life

LED System

- Contains a plurality of high brightness white LED's combined with a high reflectance upper reflector and convex transitional lens producing even distribution without pixilation
- Auto resetting, thermally protected, LED's are turned off when safe operating temperatures are exceeded
- Quick disconnect allows for tool-less replacement of LED engine from below ceiling
- 90 and 97 CRI
- 90 & 97CRI: L78 55,000 hours for 1000-2000 lumens, L90 55,000 for all other lumen output
- Color variation within 2-step MacAdam ellipses
- Available in 2400K, 2700K, 3000K, 3500K, 4000K and 5000K correlated color temperature (CCT)

Vividtune and High CRI

- 98 CRI and W2N: L70 55,000 hours
- D2W™ – dim-to-warm shifts CCT from 3000K to 1850K as fixture dims mimicking halogen sources.
- W2N - Tunable white CCT range 2700K to 6500K or 2000K to 5000K, 90 CRI. Standard
- 98 CRI** With a full-spectrum approach using broad-blue chip technology and special phosphor blends, Thrive is able to closely match the spectrum of the sun across all color temperatures. Benefits of the natural spectrum of the sun using Thrive include superior accurate color rendering, reduced eye strain, and a higher sense of emotional well-being.
- See dedicated specification sheet for more details.

Driver

- Standard 120-277V 0-10V dimming driver provides flicker free dimming from 100% to 1%
- Optional 120V leading edge/0-10V, <1% 0-10V, Fifth Light, DMX or Lutron® Ecosystem
- Distributed low voltage power system combines power, lighting, and controls with ease of installation.
- Optional magnetically guided snap in driver for ease of maintenance.

Emergency Option

- 6W battery provides 90 minutes of standby lighting, meeting most life safety codes for egress lighting.
- Available Self-Test with remote or integral charge indicator and test switch
- UL 924 listed

Connected Lighting System

Two WaveLinX connected solutions to choose from. Refer to WaveLinX system specifications and application guides for details.

WaveLinX PRO Tilemount Sensor Kit

- WaveLinX PRO WPST tilemount sensor kit offers daylight dimming, PIR motion sensing, scene and zone configuration, automatic commissioning; and optional RLTS - Real Time Location Services available.

WaveLinX PRO Wireless Node

- WaveLinX PRO WPN wireless node provides luminaire-level control with scene and zone configuration without an integrated sensor; Connects wirelessly with daylight dimming sensor and PIR motion sensor if desired. Use with 0-10V driver only. **Note:** Not compatible with 347V or Chicago plenum.

WaveLinX LITE Tilemount Sensor Kit

- WaveLinX LITE WLST tilemount sensor kit offers daylight dimming and PIR motion sensing, scene and grouping configuration.

WaveLinX LITE Wireless Node

- WaveLinX LITE WLN wireless node provides luminaire level control with scene and zone configuration without an integrated sensor; Connects wirelessly with daylight dimming sensor and PIR motion sensor if desired. Use with 0-10V driver only. **Note:** Not compatible with 347V or Chicago plenum.

WaveLinX Tilemount Kits Application

- The WPST and WLST tilemount kits include a control module mounted on the luminaire junction box via 1/2" knock-out, and a tilemount sensor on 54-inch whip; for ceiling installation by direct-mount spring clips or via mounting bracket in octagon ceiling boxes.
- The WPST and WLST tilemount kits may be ordered as factory installed on the luminaire, or ordered separately as a field installed accessory kit.
- Note: WaveLinX PRO devices are only compatible with the WaveLinX PRO system.**
- Note: WaveLinX LITE devices are only compatible with the WaveLinX LITE system.**

Code Compliance

- Thermally protected
- cULus Certified to UL 1598 / C22.2 No. 250.0 suitable for wet locations with covered ceiling
- IP66 rated when used with IP66 gasket kit accessory
- Use IP66 gasket with non conductive reflector for steam room applications up to 2000 lumens and 40°C.
- Optional City of Chicago environmental air (CCEA) marking for plenum applications
- EMI/RFI emissions per FCC CFR Title 47 Part 15 Class B at 120VAC and Class A at 277VAC
- Insulated ceiling (IC) rated up to 1,500 lumens (90 and 97CRI). All others are non-IC rated (insulation must be kept 3" from top and sides of housing).
- Can be used for State of California Title 24 high efficacy LED compliance under JA8, reference Modernized Appliance Efficiency Database System (MAEDBS) for 2016 JA8 High Efficacy Lighting*
- RoHS compliant*
- Photometric testing completed in accordance with IES LM-79
- LED life testing completed in accordance with IES LM-80-08 and TM-21-11 standards

Warranty

- Five year warranty www.cooperlighting.com/legal

Marked Spacing

4-inch Marked spacing for 90 and 97 CRI			
Lumens	Center to Center of Adjacent Luminaire (inches)	Center Luminaire to Building Side Member (inches)	Minimum Overhead Height (inches)
4000	36	18	6

Energy and Performance Data

D010 DRIVER ENERGY DATA

Series	250 lumen		500 lumen		800 lumen		1000 lumen		1500 lumen		2000 lumen	
Input Voltage 120-277VAC	120V	277V	120V	277V	120V	277V	120V	277V	120V	277V	120V	277V
Input Current (A)	0.029	0.017	0.061	0.032	0.085	0.041	0.084	0.042	0.135	0.063	0.189	0.084
Input Power (W)	3.45	3.87	7.33	7.78	10.15	10.52	10.04	10.43	16.17	16.56	22.58	22.63
In-rush (A)	2.1	8.5	3.7	8.5	3.6	8.3	3.6	8.4	2.3	9.5	2.1	9.7
Inrush duration (µs)	250	131	190	136	220	135	226	136	230	125	243	132
THDi (%)	7.21	16.92	7.82	10.78	5.57	9.63	7.78	9.24	4.75	9.93	8.03	7.44
PF	≥ 0.98	≥ 0.9	≥ 0.99	≥ 0.93	≥ 0.99	≥ 0.95	≥ 0.99	≥ 0.95	≥ 0.99	≥ 0.94	≥ 0.99	≥ 0.96

Series	2500 lumen		3000 lumen	
Input Voltage 120-277VAC	120V	277V	120V	277V
Input Current (A)	0.276	0.121	0.276	0.121
Input Power (W)	32.98	32.57	32	32.57
In-rush (A)	2.5	11.8	3.6	11.8
Inrush duration (µs)	215	111	220	111
THDi (%)	9.86	6.57	5.57	6.57
PF	≥ 0.99	≥ 0.97	≥ 0.99	≥ 0.99

Minimum starting temperature -30°C (-22°F)*
(Nominal input 120-277VAC & 100% of rated output power)

Sound Rating: Class A standards

Notes:

Emergency Battery packs are rated for a minimum starting temperature of 0°C.

COLOR METRICS - TM-30-15 & CRI/CIE

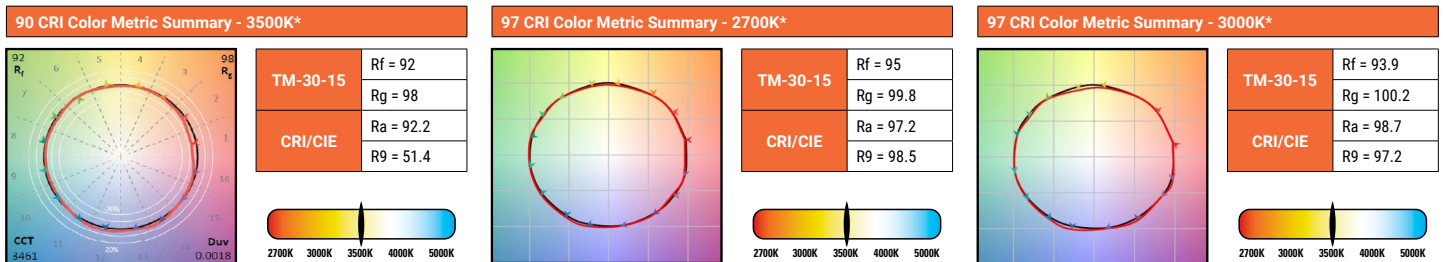

* Color values are based on haze reflector, other finishes and field results may vary.

Photometric Data

[View IES files](#)

SHALLOW 85° BEAM (H)		CANDLEPOWER DISTRIBUTION		CONE OF LIGHT		CANDELA TABLE		ZONAL LUMEN SUMMARY			LUMINANCE	
Test Number	P571640	Downlight				Degrees Vertical	Candela	Zone	Lumens	% Fixture	Average Candela Degrees	Average 0° Luminance
Housing	LDS4C15D010					0	804	0-30	565	36.7	37	72577
Module	EU4C10209035					5	798	0-40	875	56.9	45	65309
Trim	4LBSH					15	730	0-60	1384	90	55	52605
Lumens	1538					25	618	0-90	1538	100	65	34942
Efficacy	97.3 Lm/W					35	496	90-180	0	0	75	13670
SC	1.06					45	376	0-180	1538	100	85	0
						55	246					
						65	120					
						75	29					
						85	0					
						90	0					

SHALLOW 65° BEAM (LI)		CANDLEPOWER DISTRIBUTION		CONE OF LIGHT		CANDELA TABLE		ZONAL LUMEN SUMMARY			LUMINANCE	
Test Number	P571641	Downlight				Degrees Vertical	Candela	Zone	Lumens	% Fixture	Average Candela Degrees	Average 0° Luminance
Housing	LDS4C15D010					0	1145	0-30	712	44.4	37	77201
Module	EU4C10209035					5	1115	0-40	1048	65.3	45	64475
Trim	4LBSLI					15	945	0-60	1520	94.8	55	44508
Lumens	1604					25	749	0-90	1604	100	65	21163
Efficacy	101.5 Lm/W					35	534	90-180	0	0	75	1709
SC	0.91					45	371	0-180	1604	100	85	0
						55	208					
						65	73					
						75	4					
						85	0					
						90	0					

Photometric Multipliers (Nominal Lumen Values)

250 Lumen	500 Lumen	800 Lumen	1000 Lumen	1500 Lumen	2000 Lumen	2500 Lumen	3000 Lumen
0.224	0.423	0.569	0.653	1.00	1.29	1.62	1.902

Multipliers for relative lumen values with other series models.

CCT Multipliers – 90CRI

2400K	2700K	3000K	3500K	4000K	5000K
0.912	0.949	0.986	1	1.001	1.022

Multipliers for relative lumen values with other series color temperatures.

CCT Multipliers – 97CRI

2700K	3000K	3500K	4000K	5000K
0.889	0.955	1	1.016	1.07

Multipliers for relative lumen values with other series color temperatures.

Color Finish Multipliers (from H = Semi Specular Clear)

Finish code	LI	H	WMH	WH	GPH	B	MW
Finish	Specular Clear	Semi-Specular Clear	Warm Haze	Wheat	Graphite Haze	Specular Black	Matte White
Multiplier	1.25	1.00	1.02	1.02	0.72	0.55	0.95

Multipliers for relative lumen values with other color finishes.

Connected Solutions



WaveLinx LITE Wireless Node - WLN

WaveLinx LITE devices only compatible with the WaveLinx LITE system.

- Intuitive Android™ or Apple® iOS® app for basic system code compliant set up and configuration via Bluetooth
- Up to 28 unique areas per project site (WaveLinx LITE Bluetooth network)
- Up to 50 devices for an area, any one of 16 control zones, up to 6 occupancy sets, and custom lighting scenes
- Refer to the WaveLinx system specifications for details
- Not available with BioUp or Tunable White

WaveLinx mobile app settings



WaveLinx LITE Wireless Node (WLN) Wiring Diagram

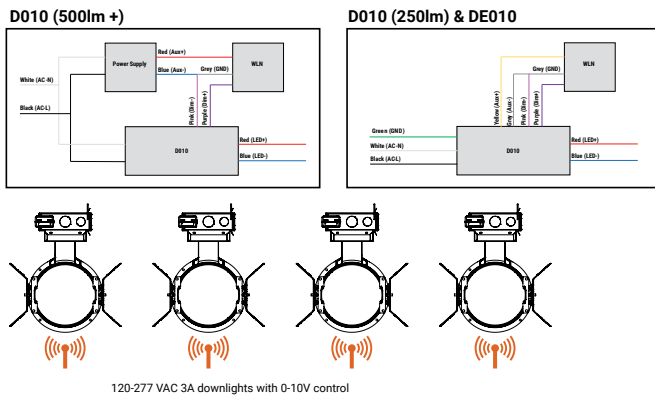

WaveLinx LITE Bluetooth Enabled System

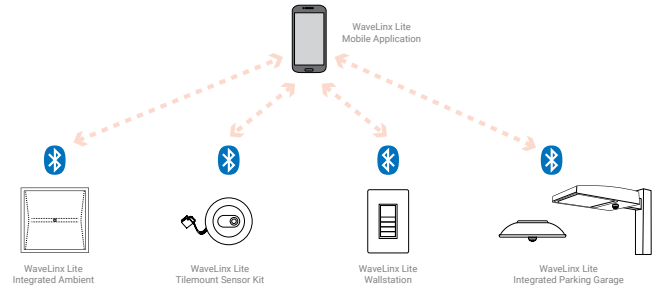

WaveLinx PRO Wireless Node - WPN

WaveLinx PRO devices only compatible with the WaveLinx PRO system.



- WaveLinx Wireless functionality configures zones and customizes settings from one secure mobile app
- Automatic code commissioning that meets the strictest codes
- Fixtures and sensors integrate with WaveLinx Area Controller, Wall Stations, and Control Devices
- Stand-Alone Offices or Entire Building Network Installations



WaveLinx mobile app settings

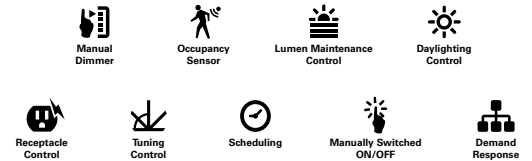

WaveLinx PRO Wireless Node (WPN) Wiring Diagram

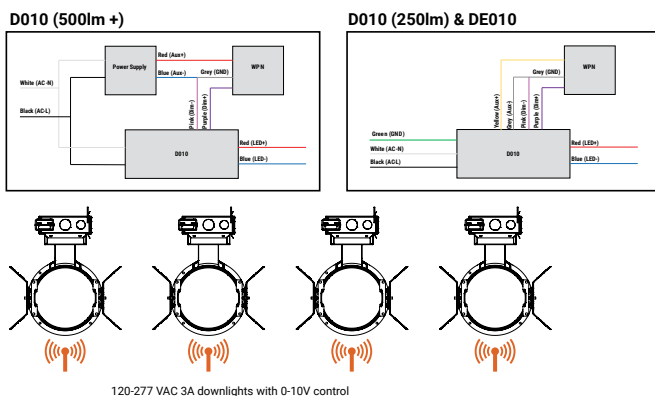

WaveLinx CORE Building Management Integration

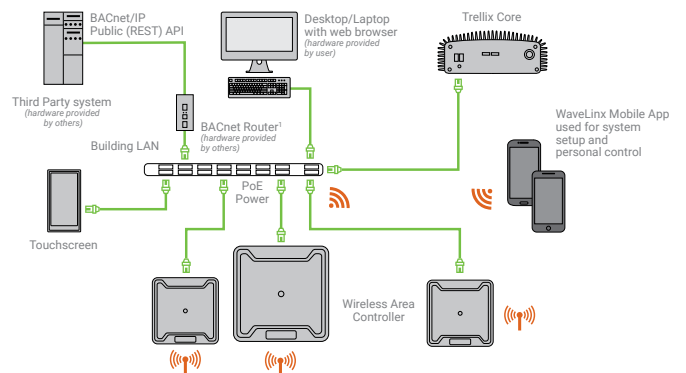

Multi-line Order Information

SAMPLE ORDER NUMBER: **LDS4C10D010TREM6**

Invoice will indicate separate fixture components (housing, trim, module) and may ship from multiple CLS facilities in separate cartons.



Domestic Preferences ⁽¹⁾	Housing	Lumens ⁽²⁾	
[Blank] =Standard BAA =Buy American Act TAA =Trade Agreements Act	LDS4C =LED Downlight 4" Nominal Aperture LDS4CCP =LED Downlight 4" Nominal Aperture, Chicago Plenum	02 =250 lumens 05 =500 lumens 08 =800 lumens 10 =1000 lumens 15 =1500 lumens	20 =2000 lumens 25 =2500 lumens 30 =3000 lumens 35 = 3500 lumens 40 = 4000 lumens

Driver	Driver Options	Options ^{(4) (25) (26) (27)}
D010 = 0-10V Dimming, 1% to 100%, 120V-277V 500-4000 lumens 3D010 =0-10V Dimming, 1% to 100%, 347V dedicated drivers for 800 to 4000 lumens; and 500 use step down transformers D010W = Fixed, Wired 0-10V Dimming, 1% to 100%, 120V-277V, 500-4000 lumens (BAA only)	Blank =Integral driver R =Remote driver (order remote driver separately) (not available with CP) PD =Magnetic Plug in Driver ⁽⁸⁾	EMB0D6ST =Bodine® 6W Self Test Emergency Module with Remote Test Switch WPN = WaveLinX PRO Wireless Node without sensor ^{(15) (31)} WLN = WaveLinX LITE Wireless Node without sensor ^{(30) (31)}
D010TR = 0-10V Dimming, 1% to 100%, 120V-277V 250- 4000 lumens 3D010TR =0-10V Dimming, 1% to 100%, 347V step down transformer 250-4000 lumens		
DE010 = 0-10V Dimming, 0.1% to 100%, 120V-277V 500-4000 lumens 3DE010 =0-10V Dimming, 0.1% to 100%, 347V step down transformer 500-4000 lumens		
D5LT = Fifth Light® (DALI T6) Logarithmic Dimming, 0.1% to 100%, 120V-277V, 500-4000 lumens 3D5LT =Fifth Light® (DALI T6) Logarithmic Dimming, 0.1% to 100% 347V step down transformer, 500-4000 lumens		
DMX = DMX/RDM Logarithmic Dimming, 0.1% to 100%, 120V-277V 800-4000 lumens ⁽⁵⁾ 3DMX =DMX/RDM Logarithmic Dimming, 0.1% to 100%, 347V step down transformer, 800-4000 ⁽⁵⁾		
DMXC5 = DMX/RDM Logarithmic Dimming, 0.1% to 100%, 120V-277V, 800-4000 lumens, RJ45 Connection ⁽⁵⁾ 3DMXC5 =DMX/RDM Logarithmic Dimming, 0.1% to 100%, 347V step down transformer, 800-4000, RJ45 Connection ⁽⁵⁾		
DLE = Lutron Ecosystem dimming 1% to 100%, 120V-277V, 800-3500 lumens 3DLE =Lutron Ecosystem dimming 1% to 100%, 347, step down transformer, 800-3500 lumens		
DLV = Low voltage dimming driver (1-100%) for use with DLVP system 800-3000 lumens (Not offered with plug in driver) ⁽⁶⁾		

SAMPLE ORDER NUMBER: **EU4C10209035**

Domestic Preferences ⁽¹⁾	Power Module	Lumen Levels ⁽²⁾	CRI ⁽¹⁴⁾	Color	
[Blank] =Standard BAA =Buy American Act TAA =Trade Agreements Act	EU4C =4-inch Universal LED Module	0208IC =250, 500, 800 lumens, IC Rated (For use with all drivers, min 500 lumen with DE010 and D5LT, min 800 lumens with DLVP, Lutron and DMX) 1020 =1000, 1500, 2000 lumens 1015IC =1000, 1500 lumens IC Rated 2540 =2500, 3000, 3500, 4000 lumens (For use with Lutron 3000-3500, DLVP 3000 lumens, DMX, D010, D010TR, D5LT and DE010 3000-4000)	90 =90 CRI Minimum 97 =97 CRI Minimum	90 CRI 24 =2400K 27 =2700K 30 =3000K 35 =3500K 40 =4000K 50 =5000K	97 CRI 27 =2700K 30 =3000K

SAMPLE ORDER NUMBER: **4LBM2H**

Domestic Preferences ⁽¹⁾	Trim	Reflector	Flange	Finish
[Blank] =Standard BAA =Buy American Act	4LB =4" LED	S =Shallow spun aluminum PS =Non-Conductive Shallow (dead front), white ^{(16) (17)} CS =Cast shallow, die cast aluminum	0 =White polymer trim ring 1 =Self flanged ⁽¹⁸⁾ 2 =White painted self flanged 4 =Knife edge rimless use with die cast only ⁽¹⁹⁾	LI =Specular Clear ⁽²⁰⁾ H =Semi-Specular Clear ⁽²⁰⁾ WMH =Warm Haze ⁽²⁰⁾ WH =Wheat ⁽²⁰⁾ GPH =Graphite Haze ⁽²⁰⁾ B =Specular Black ⁽²⁰⁾ MW =Matte White MB =Matte Black ⁽²¹⁾ MMS =Matte Metallic Silver ⁽²¹⁾

Multi-line Order Information

REQUIRED if Remote Driver (R) is specified

SAMPLE ORDER NUMBER: **RC10010D010TREM7**

Domestic Preferences ⁽¹⁾	Remote Drivers ⁽⁶⁾		Lumens ^{(2),(14)}	
[Blank] =Standard BAA =Buy American Act TAA =Trade Agreements Act	RC100 =Remote 100ft RC75 =Remote 75ft RC50 =Remote 50ft RC25 =Remote 25ft	RC15 =Remote 15ft RC5 =Remote 5ft RC2 =Remote 2ft	02 =250 lumens 05 =500 lumens 08 =800 lumens 10 =1000 lumens 15 =1500 lumens	20 =2000 lumens 25 =2500 lumens 30 =3000 lumens 35 =3500 lumens 40 =4000 lumens

Driver

<p>D010 = 0-10V Dimming, 1% to 100%, 120V-277V, 500-3000 lumens 1D010 = 0-10V Dimming, 1% to 100%, 120V, 3500-4000 lumens 2D010 = 0-10V Dimming, 1% to 100%, 277V, 3500-4000 lumens 3D010 = 0-10V Dimming, 1% to 100%, 347V dedicated drivers for 800 to 4000 lumens; and 500 lumens use step down transformer</p>
<p>D010TR = 0-10V Dimming, 1% to 100%, 120V-277V, 250-3000 lumens 1D010TR = 0-10V Dimming, 1% to 100%, 120V, 3500-4000 lumens 2D010TR = 0-10V Dimming, 1% to 100%, 277V, 3500-4000 lumens 3D010TR = 0-10V Dimming, 1% to 100% 347V step down transformer, 250-4000 lumens</p>
<p>DE010 = 0-10V Dimming, 0.1% to 100%, 120V-277V, 500-3000 lumens 1DE010 = 0-10V Dimming, 0.1% to 100%, 120V, 3500-4000 lumens 2DE010 = 0-10V Dimming, 0.1% to 100%, 277V, 3500-4000 lumens 3DE010 = 0-10V Dimming, 0.1% to 100% 0-10V Dimming 347V step down transformer, 500-4000 lumens</p>
<p>D5LT = Fifth Light® (DALI T6) Logarithmic Dimming, 0.1% to 100%, 120V-277V, 500-3000 lumens 1D5LT = Fifth Light® (DALI T6) Logarithmic Dimming, 0.1% to 100%, 120V, 3500-4000 lumens 2D5LT = Fifth Light® (DALI T6) Logarithmic Dimming, 0.1% to 100%, 277V, 3500-4000 lumens 3D5LT = Fifth Light® (DALI T6) Logarithmic Dimming, 0.1% to 100% 347V step down transformer, 500-4000 lumens</p>
<p>DMX = DMX/RDM Logarithmic Dimming, 0.1% to 100%, 120V-277V, 800-3000 lumens ⁽⁵⁾ 1DMX=DMX/RDM Logarithmic Dimming, 0.1% to 100%, 120V, 3,500-4000 ⁽⁵⁾ 2DMX=DMX/RDM Logarithmic Dimming, 0.1% to 100%, 277V, 3,500-4000 ⁽⁵⁾ 3DMX=DMX/RDM Logarithmic Dimming, 0.1% to 100%, 347V step down transformer, 800-4000 ⁽⁵⁾</p>
<p>DMXC5 = DMX/RDM Logarithmic Dimming, 0.1% to 100%, 120V-277V up to 800-3000 lumens, RJ45 Connection ⁽⁵⁾ 1DMXC5=DMX/RDM Logarithmic Dimming, 0.1% to 100%, 120V, 3,500-4000 lumens, RJ45 Connection ⁽⁵⁾ 2DMXC5=DMX/RDM Logarithmic Dimming, 0.1% to 100%, 277V, 3,500-4000 lumens, RJ45 Connection ⁽⁵⁾ 3DMXC5=DMX/RDM Logarithmic Dimming, 0.1% to 100%, 347V step down transformer, 800-4000 lumens, RJ45 Connection ⁽⁵⁾</p>
<p>DLE = Lutron Ecosystem dimming 1% to 100%, 120V-277V, 25' Max remote length, 800-3000 lumens 1DLE=Lutron Ecosystem dimming 1% to 100%, 120V, 25' Max remote length, 3500 lumens 2DLE=Lutron Ecosystem dimming 1% to 100%, 277V, 25' Max remote length, 3500 lumens 3DLE=Lutron Ecosystem dimming 1% to 100%, 347V, step down transformer, 25' Max remote length, 800-3500 lumens</p>
<p>DLV = Low voltage dimming driver (1-100%) for use with DLVP system, 800-3000 lumens ⁽⁵⁾</p>

Options

Options	Controls
<p>EMB0D=Bodine® Emergency Module with Remote Test Switch EMB0D6ST=Bodine® 6W Self Test Emergency Module with Remote Test Switch EM7=7W Emergency Module with Remote Test Switch EM14=14W Emergency Module with Remote Test Switch</p>	<p>EMB0D7ST=Bodine® Self Test Emergency Module EMV7=7W Low Voltage Emergency Module with Remote Test Switch ⁽⁷⁾ EMV14=14W Low Voltage Emergency Module with Remote Test Switch ⁽⁷⁾ ETRD=Emergency transfer device ⁽²⁸⁾</p>
	<p>WPST=Factory installed WaveLinX PRO Sensor Kit ^{(11) (13)} WLST=Factory installed WaveLinX LITE Sensor Kit ^{(11) (21)} WPN = WaveLinX PRO Wireless Node without sensor ^{(15) (31)} WLN = WaveLinX LITE Wireless Node without sensor ^{(30) (31)}</p>

Accessories (Order Separately) ⁽²²⁾

<p>TRM4P=White Metal Trim Ring ⁽²³⁾ LGSKT4IP66=IP66 Gasket Kit</p>	<p>RPM4MW=Rimless Millwork Ring, Matte White ⁽²³⁾ RP4MB=Rimless Millwork Ring, Matte Black ⁽²³⁾ RKM4MW=Knife Edge Millwork Ring, Matte White ⁽²⁴⁾ RKM4MB=Knife Edge Millwork Ring, Matte Black ⁽²⁴⁾</p>	<p>Bar Hangers TAA-HB26=C-channel Bar Hanger, 26" Long, Pair ⁽¹⁾ BAA-HB26=C-channel Bar Hanger, 26" Long, Pair ⁽¹⁾ HB26=C-channel Bar Hanger, 26" Long, Pair HB50=C-channel Bar Hanger, 50" Long, Pair RMB22=Wood Joist Bar Hanger, 22" Long, Pair</p>	<p>Connected Lighting Systems ^{(6) (11)} WPST = Field installed WaveLinX PRO Sensor Kit ⁽¹³⁾ WLST = Field installed WaveLinX LITE Sensor Kit ⁽¹²⁾</p>
<p>PRR4=Rimless Plaster Ring ⁽²³⁾ RKP4=Knife Edge plaster Ring ⁽²⁴⁾</p>	<p>HSA4=Slope Adapter for 4" Aperture Housings, Specify Slope ⁽²⁵⁾</p>		

- Notes:**
- Only product configurations with these designated prefixes are built to be compliant with the Buy American Act of 1933 (BAA) or Trade Agreements Act of 1979 (TAA), respectively. Please refer to [DOMESTIC PREFERENCES](#) website for more information. Components shipped separately may be separately analysed under domestic preference requirements. Offered with shallow (S) spun aluminum.
 - Nominal Lumens will vary depending on selected color, CRI, driver and reflector finish. Reference [Multiplier tables](#).
 - DMX fixtures default to full on upon loss of DMX signal.
 - Not available with Chicago Plenum.
 - ULus listed only
 - Not available with DLVP
 - Refer to system specifications for additional information, features, and benefits. Order either factory installed option or accessory. Use with 0-10V driver.
 - WLST = WaveLinX LITE tilemount sensor kit for daylight dimming, PIR motion sensing, use with D010 only (Refer to WaveLinX LITE system specifications)
 - WPST = WaveLinX PRO wireless sensor kit for daylight dimming, PIR motion sensing, and optional RLTS - Real Time Location Services, use with 0-10V only.
 - IC rated up to 3000 lumens for 90 & 97 CRI
 - WPN = WaveLinX PRO wireless node provides luminaire level control with scene and zone configuration without an integrated sensor; Connects wirelessly with daylight dimming sensor and PIR motion sensor if desired. Use with D010 or DE010 drivers only.
 - PS available in self-flanged MW finish only
 - Offered up to 2000 lumens
 - Flange is the same finish as the reflector
 - Requires knife edge ring
 - Anodized or spun reflectors
 - Die cast only
 - Accessories sold separately will be separately analyzed under domestic preference requirements. Consult factory for further information.
 - Order trim with polymer trim ring.
 - Order die cast trim with flange type 4
 - For remote driver order emergency module with the remote driver
 - If using remote driver order battery and controls with the remote driver.
 - 120V-277V
 - Used to bypass local control during outage. Must be used in conjunction with UL 1008 device (provided by others).
 - Not recommended for use with Wall Wash
 - WLN = WaveLinX LITE wireless node provides luminaire level control with scene and zone configuration without an integrated sensor; Connects wirelessly with daylight dimming sensor and PIR motion sensor if desired. Use with D010 or DE010 drivers only.
 - Not compatible with 347V or Chicago plenum.

Dimensional and Mounting Details

