

Project		Catalog #		Type	
Prepared by		Notes		Date	



Metalux

OHB LED

LED High Bay Efficiency Luminaire 2' Length

Typical Applications

Industrial • Commercial • Manufacturing • Food Processing • Sports / Multi-Purpose

Interactive Menu

- Order Information page 2
- Photometric Data page 3
- Control Solutions page 6
- Product Warranty

Product Certification



Product Features



Top Product Features

- Precision designed optical performance
- Offered in both standard and high efficacy versions
- High performance efficacy up to 200 lm/W
- Efficient 1-for-1 replacement of linear fluorescent & HID fixtures
- Lumen packages – 9K, 12K, 15K, 18K, 24K, 30K, 36K
- Narrow, medium, and wide distribution
- Options to meet Buy American and other domestic preference requirements

Dimensional and Mounting Details

OHB-9SE, 12SE, 15SE

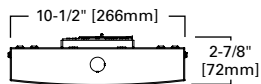

OHB-9HE, 12HE, 15HE, 18HE, 18SE, 24SE, 30SE

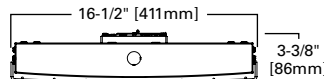
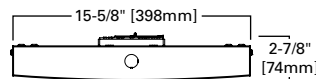

OHB-24HE, 30HE, 36SE

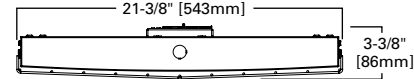
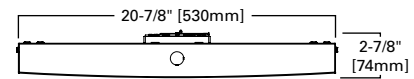

2' Side View

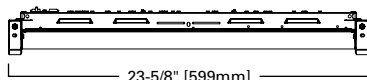

[additional product diagrams](#)

Order Information

SAMPLE ORDER NUMBER: **OHB-24SE-MFL-UNV-L840-CD-WLS4-U** Includes V Hangers for rapid installation

Domestic Preferences ⁽¹⁾	Series ⁽²⁾	Lumen Package	Efficacy	Distribution/Shielding	Voltage ^{(4), (5), (6)}	CCT/CRI
[Blank] =Standard BAA =Buy American Act TAA =Trade Agreements Act	OHB=Optimized High Bay, 2 ft.	9 =9,000 Lumens 12 =12,000 Lumens 15 =15,000 Lumens 18 =18,000 Lumens 24 =24,000 Lumens 30 =30,000 Lumens 36 =36,000 Lumens	SE =Standard Efficacy HE =High Efficacy ⁽³⁾	A =Aisle N =Narrow MFL =Medium Frosted MCL =Medium Clear W =Wide NL =No Lens	120V =120 Volt 277V =277 Volt 347V =347 Volt 480V =480 Volt UNV =Universal Voltage 120-277 UNC =Universal Voltage 347/480	L730 =70CRI / 3000K L735 =70CRI / 3500K L740 =70CRI / 4000K L750 =70CRI / 5000K L830 =80CRI / 3000K L835 =80CRI / 3500K L840 =80CRI / 4000K L850 =80CRI / 5000K L930 =90CRI / 3000K L935 =90CRI / 3500K L940 =90CRI / 4000K L950 =90CRI / 5000K
Notes <small>(1) Only product configurations with these designated prefixes are built to be compliant with the Buy American Act of 1933 (BAA) or Trade Agreements Act of 1979 (TAA), respectively. Please refer to DOMESTIC PREFERENCES website for more information. Components shipped separately may be separately analyzed under domestic preference requirements.</small>	Notes <small>(2) DesignLights Consortium® Qualified and classified for both DLC Standard and DLC Premium, refer to www.designlights.org for details.</small>		Notes <small>(3) HE not available for 36K lumens.</small>		Notes <small>(4) Voltage must be specified when ordered with plugs or emergency drivers. (5) When ordering sensor or EBP/TD option, specify as UNV (for 120V or 277V), 347V or 480V. (6) Ambient temperatures limited to 40C when using emergency, sensors, or SLTD in conjunction with 347V or 480V.</small>	

Options	Driver Type	Wiring	Options / Integrated Sensor	Packaging
UPL __=Uplight (Select lumens from 12, 15, 18, 24, 30, 36) Refer to compatibility chart below ⁽¹⁵⁾ Emergency * EL20W =20-watt 120V-277V emergency battery pack installed ^{(7), (8), (10), (11), (12), (14)} EL20-W-REM =20-watt 120V-277V emergency battery pack remote mounted ^{(7), (8), (11), (12), (14)} ETRD = 120-277V Emergency Transfer Relay with dimming control ^{(9), (10), (13)}	CD =Standard Dimming Driver SLTD =DALI Driver ^{(16), (17), (18)}	C3 (1) =1 Circuit, 3' Cord with no Plug C3 (2) =2 Circuits, 3' Cord with no Plug C6 (1) =1 Circuit, 6' Cord with no Plug C6 (2) =2 Circuits, 6' Cord with no Plug C10 (1) =1 Circuit, 10' Cord with no Plug C10 (2) =2 Circuits, 10' Cord with no Plug PC3/120 =(NEMA L5-15P) 3' Cord with NEMA Plug PC3/277 =(NEMA L7-15P) 3' Cord with NEMA Plug PC3/347 =(NEMA L24-20P) 3' Cord with NEMA Plug PC3/480 =(NEMA L8-20P) 3' Cord with NEMA Plug PC6/120 =(NEMA L5-15P) 6' Cord with NEMA Plug PC6/277 =(NEMA L7-15P) 6' Cord with NEMA Plug PC6/347 =(NEMA L24-20P) 6' Cord with NEMA Plug PC6/480 =(NEMA L8-20P) 6' Cord with NEMA Plug	MP =Modular Plug ⁽²⁰⁾ PAF =Painted After Fabrication HA =High Ambient ^{(21), (22)} IP5X =Optics IP5X rated Integrated Sensors MS =360° or 180° Motion Sensor Installed, (specify voltage) ^{(19), (25), (27)} OEFP010VMV =Occupancy Sensor with Integrated Photocell ^{(19), (25), (28)} FSP-211/L7 =PIR Occupancy Sensor with integral 0-10V Dimming ^{(19), (23), (24), (27)} FSP-321/L7 =PIR Occupancy Sensor with Integral 0-10V dimming ^{(19), (24), (28)} LWR =Enlighted Wireless Sensor system ^{(19), (27)} WLS4 =WaveLinx LITE, Dimming Motion and Daylight, Bluetooth Programmable, 15' - 40' Mounting ^{(19), (27), (29), (31)} WPS4 =WaveLinx PRO, Dimming Motion and Daylight, WAC Programmable, 15' - 40' Mounting ^{(19), (27), (31)} ZLD1Z =Leviton 120-277V PIR Occupancy Sensor with integral 0-10V Dimming ^{(25), (30)} ZLDUZ =Leviton 347-480V PIR Occupancy Sensor with integral 0-10V Dimming ^{(19), (24), (26), (27)}	U =Unit Pack PALC =Job Pack, in carton
Notes <small>* Emergency and transfer devices are UL924 listed. (7) For approximate delivered lumens multiply the lumens per watt of the desired fixture by the wattage of the emergency battery pack. (8) EM options available in 0°C - 45°C ambient. (9) Used to transfer fixture to secondary power during outage. Must be used in conjunction with UL 1008 device (provided by others). (10) OHB-SPM mounting not available with EL20W or ETRD options. (11) Refer to Ambient Chart for temperature ratings. (12) Ambient temperatures limited to 40C when using emergency, sensors, or SLTD in conjunction with 347V or 480V. (13) Not available with 36SE lumen package. (14) Not available with UNC (347V or 480V) for 36K lumens due to space constraints. (15) Uplight not available in 70CRI, 480V or UNC, 9k lumens. Not available when combining 36SE and ETRD. *Ambient temp limited to 40C.</small>	Notes <small>(16) Sensor or UNC not available in conjunction with SLTD driver. (17) SLTD not available for 36SE Lumen Package. (18) UPL12 not available in conjunction with SLTD</small>		Notes <small>(19) When ordering sensor or EBP/TD option, specify as UNV (for 120V or 277V), 347V or 480V. (20) Requires use of MC or MPC cord accessories, specify voltage for plugs (MP). (21) High Ambient not available with integrated emergency. (22) HA not offered for 9HE, 9SE, 12HE, 12SE, 15HE, 24HE, 24SE, 30HE, and 36SE. (23) Available for UNV (for 120V or 277V) only. (24) Available for UNC (for 347V or 480V) only. (25) UNV and 347V only. (26) Sensor requires sidecar when specified in 36K lumen package. (27) Sensor option not available for 36K lumen package with 347V or 480V. (28) Sensor option not available for 36K lumen package with 480V.</small>	

Accessories (order separately) ⁽³¹⁾
OHB-WG112 =Wire guard for 9SE, 12SE and 15SE OHB-WG162 =Wire guard for 9HE, 12HE, 15HE, 18HE, 18SE, 24SE, and 30SE OHB-WG222 =Wire guard for 24HE, 30HE, and 36SE Y-TOGGLE __- 2PK =(2) Y-Toggle Cable Kits (Specify 10 or 30 for length in feet) FH-1 =Fixture Hook ⁽³⁰⁾ FL-1 =Fixture Loop ⁽³⁰⁾ OHB-SPM =Single Point Mounting Hub ⁽²⁹⁾ MPC3 =3' Modular Power Cord & Plug (Specify Voltage) MPC6 =6' Modular Power Cord & Plug (Specify Voltage) MC3 =3' Modular Power Cord MC6 =6' Modular Power Cord
Notes <small>(29) Single Point Mounting not available with integrated emergency. (30) Must be used in conjunction with OHB-SPM accessory for proper installation. (31) Accessories sold separately will be separately analyzed under domestic preference requirements. Consult factory for further information.</small>

		Uplight Lumens and Wattage					
		UPL12	UPL15	UPL18	UPL24	UPL30	UPL36
		1200	1500	1800	2400	3000	3600
OHB	Downlight Lumens SE & HE	8.4W	10.3W	12.3W	17.4W	23.2W	28.8W
	12	12,000	X		X		
	15	15,000		X		X	
	18	18,000	X		X		
	24	24,000	X			X	X
	30	30,000		X			X
36	36,000			X			X

Notes: Uplight not available in 70 CRI

Product Specifications

Construction

- Rugged and durable scalable design with rigid, steel center channel
- Mechanically attached end caps provide strength and durability
- Suspension mounting with optional wire hook and chain set or cable; Single monopoint mounting with SPM tong hanger

Electrical

- Long-Life LED system coupled with electrical driver for optimal performance
- LED's available in 3000K, 3500K, 4000K and 5000K with 70 CRI, 80 CRI and 90 CRI options
- Electronic drivers are available for 120-277V, 347V and 480V applications
- 0-10V dimming control (standard)
- Operating temperature of -40°C to 55°C (refer to chart)

Emergency Battery Pack Option

- 20-watt, 120-277V integral emergency battery pack available to meet critical life-safety lighting requirements

- 90-minute batteries provide constant power to the LED system, ensuring code-compliance
- Integral emergency transfer relay available for generator equipped power systems

Optics

- Precision designed optics deliver even illumination
- Offered in narrow, medium and wide distributions

Shielding

- Standard lensing provides additional LED protection and optical control
- Optional wire guards available for more complex environments

Controls

- Integrated WaveLinx sensor options provide wireless individual fixture control and enable code compliance, increased energy savings, grouping of fixtures, and connection to WaveLinx control systems
- WaveLinx industrial sensors offer installation heights up to 40 feet (45ft major motion) and have coverage patterns up to 5000 square feet (see sensor specifications - field of view)

Finish

- White enamel finish preceded by a multistage cleaning cycle
- Iron phosphate coating with rust inhibitor protects against contaminants and oxidation

Compliance

- cULus listed for damp locations
- LED modules comply with IESNA LM-79 and LM-80 standards
- DesignLights Consortium® Qualified and classified for both DLC Standard and DLC Premium (refer to www.designlights.org for details)

Warranty

- Five year warranty standard.

Photometric Data

[View IES files](#)

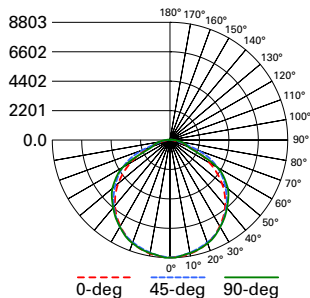

OHB-24SE-MCL-UNV-L840-CD-U

Electronic Driver
 Linear LED 4000K
 Spacing criterion: (H) 1.26 x mounting height, (L) 1.27 x mounting height
 Lumens: 24831
 Input Watts: 146.6W
 Efficacy: 169.4 LPW
 Test Report: OHB-24SE-MCL-UNV-L840-CD-U.IES

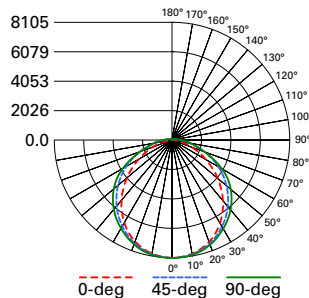

OHB-24SE-MFL-UNV-L840-CD-U

Electronic Driver
 Linear LED 4000K
 Spacing criterion: (H) 1.21 x mounting height, (L) 1.29 x mounting height
 Lumens: 24234
 Input Watts: 146.6W
 Efficacy: 165.3 LPW
 Test Report: OHB-24SE-MFL-UNV-L840-CD-U.IES

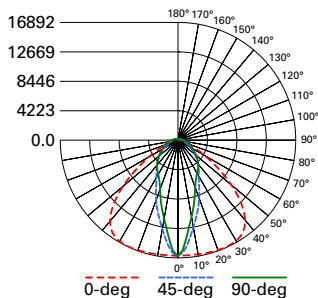

OHB-24SE-N-UNV-L840-CD-U

Electronic Driver
 Linear LED 4000K
 Spacing criterion: (H) 1.47 x mounting height, (L) 0.53 x mounting height
 Lumens: 24628
 Input Watts: 146.6W
 Efficacy: 168 LPW
 Test Report: OHB-24SE-N-UNV-L840-CD-U.IES

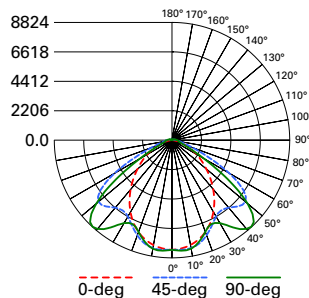

OHB-24SE-W-UNV-L840-CD-U

Electronic Driver
 Linear LED 4000K
 Spacing criterion: (H) 1.14 x mounting height, (L) 1.58 x mounting height
 Lumens: 24679
 Input Watts: 146.6W
 Efficacy: 168.3 LPW
 Test Report: OHB-24SE-W-UNV-L840-CD-U.IES

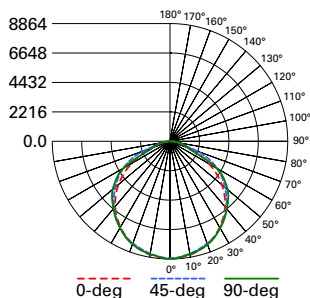

OHB-24SE-A-UNV-L840-CD-U

Electronic Driver
 Linear LED 4000K
 Spacing criterion: (H) 1.26 x mounting height, (L) 1.27 x mounting height
 Lumens: 25003
 Input Watts: 146.6W
 Efficacy: 170.6 LPW
 Test Report: OHB-24SE-A-UNV-L840-CD-U.IES

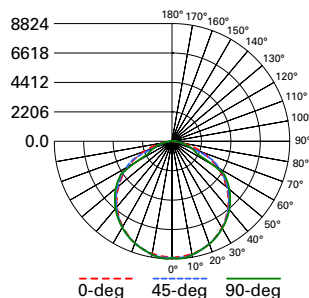

OHB-24SE-NL-UNV-L840-CD-U

Electronic Driver
 Linear LED 4000K
 Spacing criterion: (H) 1.14 x mounting height, (L) 1.58 x mounting height
 Lumens: 24679
 Input Watts: 146.6W
 Efficacy: 168.3 LPW
 Test Report: OHB-24SE-NL-UNV-L840-CD-U.IES

Energy and Performance Data by Catalog Number

OHB SE- 5000K 70CRI													
Catalog Number	Lumen Output						Watts	Efficacy (LPW)					
	A	N	MFL	MCL	W	NL	277V	A	N	MFL	MCL	W	NL
OHB-9SE	9041	8905	8762	8978	8923	9365	54	167	165	162	166	165	173
OHB-12SE	12554	12366	12168	12468	12392	13005	75.6	166	163	161	165	164	172
OHB-15SE	15869	15631	15381	15760	15663	16439	97	164	161	159	162	161	169
OHB-18SE	19978	19678	19363	19840	19719	20695	108	185	182	179	184	183	192
OHB-24SE	26323	25927	25513	26142	25982	27268	147	179	176	174	178	177	185
OHB-30SE	31485	31012	30516	31268	31076	32615	181	174	171	169	173	172	180
OHB-36SE	37793	37226	36630	37533	37303	39150	226	167	165	162	166	165	173

OHB - SE 5000K 80CRI													
Catalog Number	Lumen Output						Watts	Efficacy (LPW)					
	A	N	MFL	MCL	W	NL	277V	A	N	MFL	MCL	W	NL
OHB-9SE	8612	8483	8347	8553	8501	8922	54	159	157	155	158	157	165
OHB-12SE	11960	11780	11592	11877	11805	12389	75.6	158	156	153	157	156	164
OHB-15SE	15117	14890	14652	15013	14921	15660	97	156	154	151	155	154	161
OHB-18SE	19031	18745	18445	18900	18784	19714	108	176	174	171	175	174	183
OHB-24SE	25076	24699	24304	24903	24751	25976	147	171	168	165	169	168	177
OHB-30SE	29993	29542	29070	29786	29604	31070	181	166	163	161	165	164	172
OHB-36SE	36003	35462	34895	35755	35536	37295	226	159	157	154	158	157	165

OHB - HE 5000K 70CRI													
Catalog Number	Lumen Output						Watts	Efficacy (LPW)					
	A	N	MFL	MCL	W	NL	277V	A	N	MFL	MCL	W	NL
OHB-9HE	9533	9390	9240	9468	9410	9876	52	183	181	178	182	181	190
OHB-12HE	12424	12237	12041	12338	12262	12870	70	177	175	172	176	175	184
OHB-15HE	15610	15375	15129	15502	15407	16170	80	195	192	189	194	193	202
OHB-18HE	18747	18465	18170	18618	18504	19420	105	179	176	173	177	176	185
OHB-24HE	24648	24278	23890	24478	24328	25533	128.6	192	189	186	190	189	199
OHB-30HE	30904	30440	29953	30691	30503	32014	166.6	185	183	180	184	183	192

OHB - HE 5000K 80CRI													
Catalog Number	Lumen Output						Watts	Efficacy (LPW)					
	A	N	MFL	MCL	W	NL	277V	A	N	MFL	MCL	W	NL
OHB-9HE	9082	8945	8802	9019	8964	9408	52	175	172	169	173	172	181
OHB-12HE	11835	11657	11471	11754	11682	12260	70	169	167	164	168	167	175
OHB-15HE	14870	14647	14412	14768	14677	15404	80	186	183	180	185	183	193
OHB-18HE	17858	17590	17309	17736	17627	18500	105	170	168	165	169	168	176
OHB-24HE	23480	23128	22758	23319	23176	24323	128.6	183	180	177	181	180	189
OHB-30HE	29440	28998	28534	29237	29058	30497	166.6	177	174	171	175	174	183

Optional Uplight will increase input wattages - refer to Uplight Chart for added wattage.

Energy and Performance Data by Catalog Number

Ambient Ratings

Lumen Package	Standard	(HA) High Ambient	EM
OHB-9SE	65°C	–	45°C
OHB-9HE	65°C	–	45°C
OHB-12SE	55°C	–	45°C
OHB-12HE	55°C	–	45°C
OHB-15SE	45°C	55°C	45°C
OHB-15HE	55°C	–	45°C
OHB-18SE	45°C	55°C	45°C
OHB-18HE	45°C	55°C	45°C
OHB-24SE	55°C	–	45°C
OHB-24HE	55°C	–	45°C
OHB-30SE	45°C	50°C	45°C
OHB-30HE	55°C	–	45°C
OHB-36SE	50°C	–	45°C

Energy Data

Input Watts:
9SE (9,000 lumens)=54W
9HE (9,000 lumens)=52W
12SE (12,000 lumens)=76W
12HE (12,000 lumens)=70W
15SE (15,000 lumens)=97W
15HE (15,000 lumens)=80W
18SE (18,000 lumens)=108W
18HE (18,000 lumens)=105W
24SE (24,000 lumens)=147W
24HE (24,000 lumens)=130W
36SE (30,000 lumens)=181W
30HE (30,000 lumens)=169W
36SE (36,000 lumens)=226W

Shipping Data

Catalog No.	Wt.
OHB-9SE	10 lbs.
OHB-9HE	13 lbs.
OHB-12SE	10 lbs.
OHB-12HE	10 lbs.
OHB-15SE	13 lbs.
OHB-15HE	13 lbs.
OHB-18SE	13 lbs.
OHB-18HE	13 lbs.
OHB-24SE	13 lbs.
OHB-24HE	13 lbs.
OHB-30SE	16 lbs.
OHB-30HE	16 lbs.
OHB-36SE	20 lbs.

Optional Uplight will increase input wattages - refer to Uplight Chart for added wattage.

Modular Power Supply Option

Modular Power Supply option is available for use with all F-Bay products. The modular power supply allows external fixture access for safe and easy servicing. There is no need to remove lamps or reflectors to disconnect fixture power with Modular Power Supply. Access to the individual fixture's power supply allows servicing without turning off all the fixtures, disrupting occupants. F-Bay Modular Power Supply is a time saver in installation – **simply plug & power.**



1. Modular Power Supply Receptacle supplied mounted into fixture Access Plate.
2. Modular Power Cord & Plugs in 120, 277, 347, & 480V configurations for easy plug & power into existing supply.

No internal fixture access required for installation or disconnecting power.

Lumen Maintenance

Ambient Temperature	TM-21 Lumen Maintenance (60,000 hours)	Theoretical L70 (Hours)
25°C	> 89%	> 182,000

Code Compliance

- UL/cUL Certified for Make/Break under load (UL2549)
- Meets NEC requirements for ballast disconnect (NEC 410.73G)
- Receptacle complete with insulating/dust cap

Dimensional and Mounting Details

OHB-9SE, 12SE, 15SE

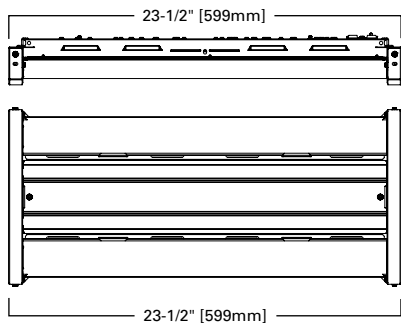
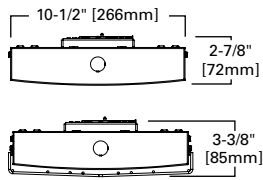

OHB-9HE, 12HE, 15HE, 18HE, 18SE, 24SE, 30SE

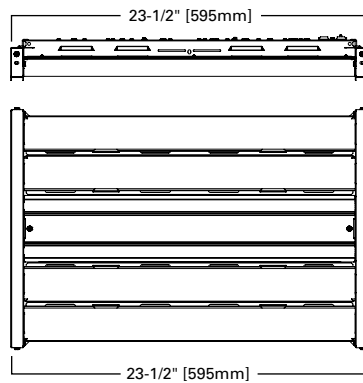
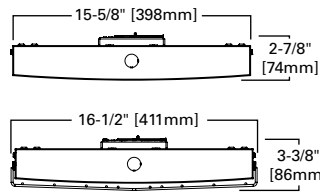

OHB-24HE, 30HE, 36SE

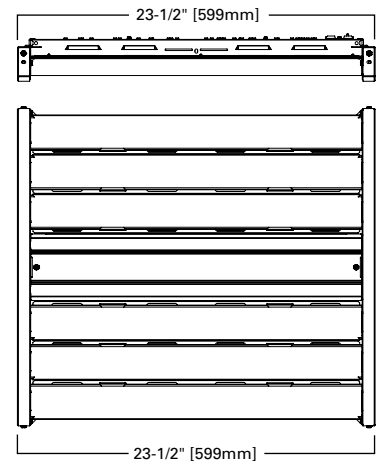
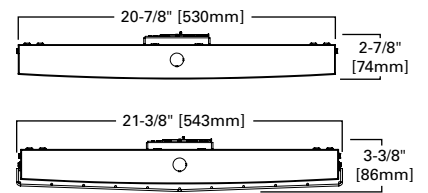

OHB 36SE with Sidecar

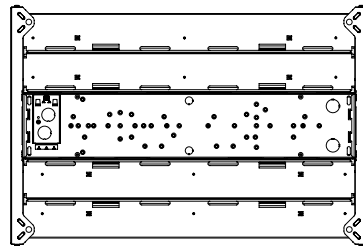
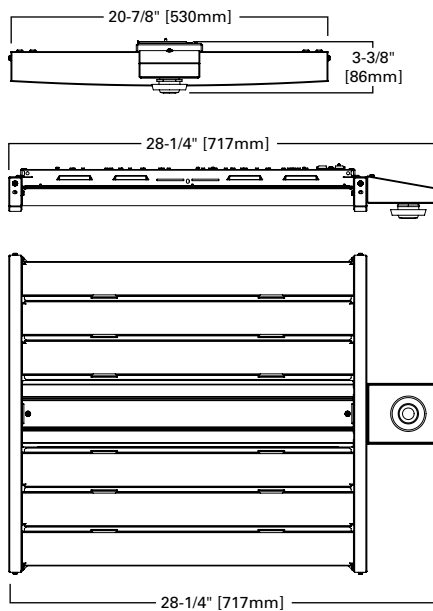

OHB with EBP

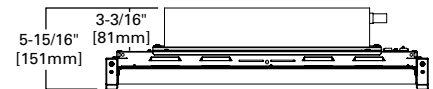

Control Solutions

- WaveLinX LITE wireless
- WaveLinX PRO wireless
- WaveLinX CAT wired
- WaveLinX Wired



The OHB with WaveLinX offers no-hassle lighting control with multiple luminaire level control solutions.



WaveLinX PRO is a wireless lighting control solution, for connected spaces, that significantly reduces a building's energy consumption. From a single floor to an entire campus, WaveLinX PRO connects more than lighting assets; it shares aggregated sensor data with the WaveLinX CORE platform and other building systems, so building owners can improve operations, spaces environment, and tenants' experience. WaveLinX PRO offers a rich portfolio of wireless devices, WaveLinX PRO-enabled luminaires, and an intuitive WaveLinX mobile app for office, education, warehouse, and parking garage applications.



WaveLinX LITE is a cost effective, wireless digital lighting control solution, with out-of-the-box functionality, that saves energy and meets code. It's designed for applications that require occupancy-based, daylighting, or manual light control. Customize installations for office, education, warehouse and parking garages using the secure, simple mobile app.

Integrated Sensor Coverage Pattern

WaveLinX PRO/LITE Sensor – WLS2 and WPS2

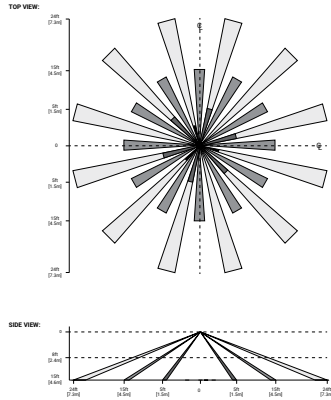

WaveLinX PRO/LITE Sensor – WLS4 and WPS4

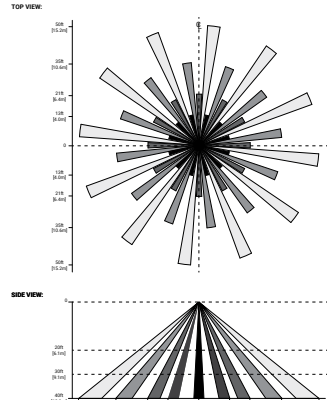

With Integrated WaveLinX Sensor

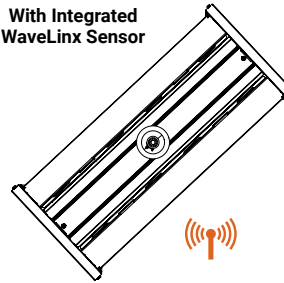

Integrated Controls Options

Option	Out of the Box Functionality	Luminaire Level Lighting Control (LLLC)	Automatic Dimming Photocell	Occupancy Sensing	CCT Control
WLS	X	X	X	X	
WPS		X	X	X	

Systems comparison chart

Cooper Lighting Solutions provides many lighting system solutions designed to satisfy code requirements and meet the unique needs of any project.



Luminaire with standalone sensor



Standalone Spaces WaveLinX LITE



Standalone Spaces WaveLinX CAT



Networked Spaces WaveLinX PRO



Enterprise WaveLinX CORE

	Luminaire with standalone sensor	Standalone Spaces WaveLinX LITE	Standalone Spaces WaveLinX CAT	Networked Spaces WaveLinX PRO	Enterprise WaveLinX CORE
Occupancy	Yes	Yes	Yes	Yes	Yes
Daylighting	Yes	Yes	Yes	Yes	Yes
Wallstations	-	Yes	Yes	Yes	Yes
Gateways	-	-	-	1 WAC	300 WACs
Devices (MAX)	-	40 per Area (1120 per space)	40 per Area	200 per WAC2	32,500 per CORE Enterprise
Software	-	WaveLinX LITE Mobile App	WaveLinX CAT Mobile App	WaveLinX Mobile App	CORE
Areas	-	28 per Space	Unlimited	50 per WAC2	up to 3,000
Zones	-	16 per Area	16 per Area	16 per Area	up to 9,000
Scheduling	-	-	-	Local	Global
VividTune™	-	-	-	Yes	Yes
Plug-Load Control	-	Yes	Yes	Yes	Yes
Low-Voltage Power	-	-	Yes	Yes	Yes
Integration	-	-	-	-	BACnet, API
Dashboards	-	-	-	-	Energy, Occupancy
Configuration	-	Installer	Installer	Technician	Technician / IT