

Project		Catalog #		Type	
Prepared by		Notes		Date	

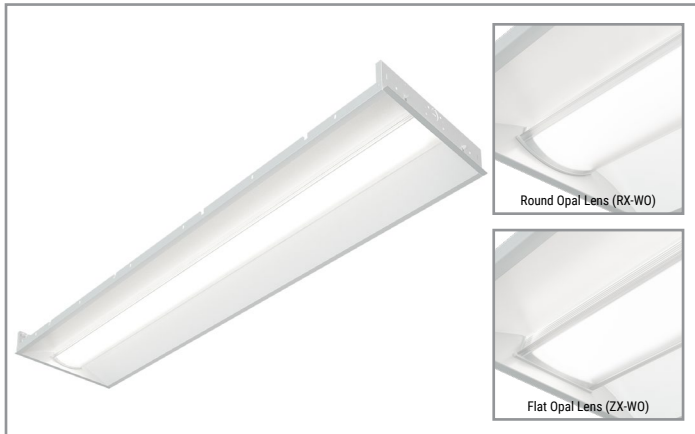

Corelite

Class RX / ZX LED

1' x 4' Recessed
2-1/4" Depth

Typical Applications

• Commerical Office Spaces • Schools • Hospitals • Retail Merchandising Areas

Interactive Menu

- Order Information [page 2](#)
- Photometric Data [page 3](#)
- Energy and Performance Data [page 3](#)
- VividTune™ Color Tuning Solutions [page 4](#)
- Product Warranty

Product Certification



Product Features



Top Product Features

- Architectural quality design with Class R round (R) and flat (Z) lens variations
- Standard and High Performance lumen packages up to 140 lumens per watt
- Three CCT options: 3000K, 3500K and 4000K at 80 or 90CRI
- VividTune CCT tuning options from 3000K–5000K or 2700K-6500K
- Options to meet Buy American and other domestic preference requirements

Dimensional and Mounting Details

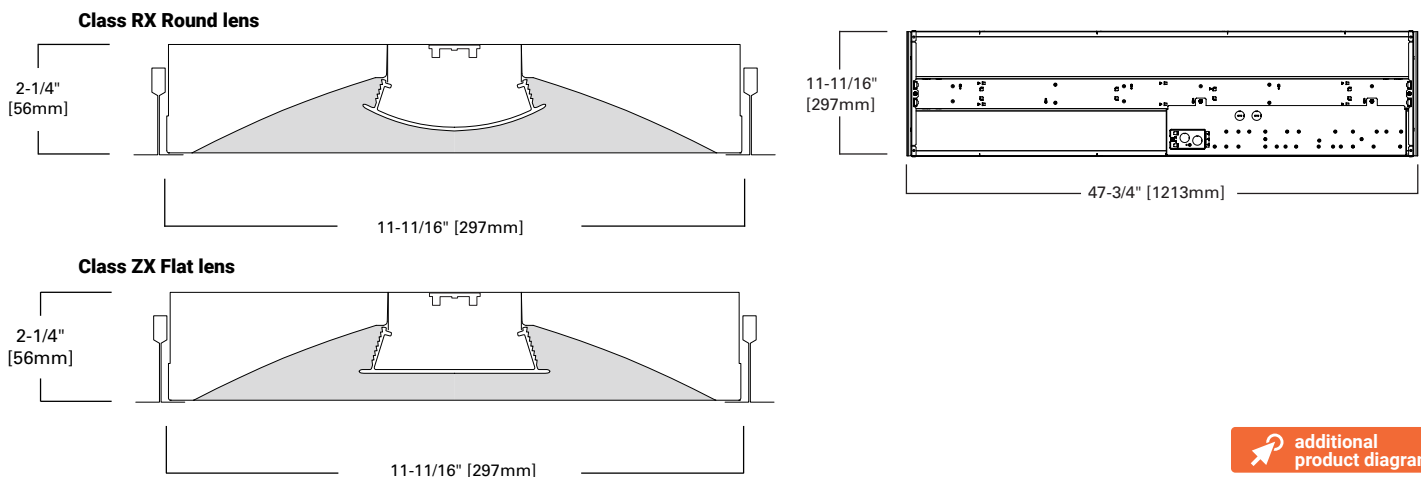

[additional product diagrams](#)

Order Information

SAMPLE ORDER NUMBER: **RX-WO-44L835-UNV-14-T1-STD**

Domestic Preferences	Series	Shielding	Lumen Package	CRI	Color Temperature	Input Voltage
[Blank] =Standard BAA =Buy American Act TAA =Trade Agreements Act	RX =Class RX LED Recessed, Round Lens ZX =Class ZX LED Recessed, Flat Lens	WO =Opal Smooth Lens	20L =2000 Lumen, 16W 29L =2900 Lumen, 24W 39L =3900 Lumen, 29W 44L =4400 Lumen, 38W 48L =4800 Lumen, 37W 60L =6000 Lumen, 48W	8 =80+ CRI 9 =90+ CRI	30 =3000K 35 =3500K 40 =4000K 3050 =Tunable White 3000K-5000K 2765 =Tunable White 2700K-6500K	UNV =Universal (120V-277V) 347 =347V 48V =48V Low-voltage (Class 2)
Notes Only product configurations with these designated prefixes are built to be compliant with the Buy American Act of 1933 (BAA) or Trade Agreements Act of 1979 (TAA), respectively. Please refer to DOMESTIC PREFERENCES website for more information. Components shipped separately may be separately analyzed under domestic preference requirements.	Notes	Notes	Notes Refer to performance table on Page 3 for more detail.	Notes White tuning provides correlated color temperatures (CCT) between 3000K (warm) to 5000K (cool) or 2700K (warm) to 6500K (cool). Must be used in conjunction with W2A driver only. Must be used with two (2) 10V dimming control channels, 1 color, 1 intensity. Vivid Tune is not DLC Qualified.	Notes 347V versions are not available with emergency or sensor options.	

Size	Ceiling Type	Driver Type	Integrated Sensing Systems	Emergency Options	Options
14 =1'x4'	T1 =15/16" Grid/Lay-in (Flush), Concealed T, and Slot Grid T9T =9/16" Grid Tegular Trim	STD =Standard 0-10V (1%-100%) 5LT =DALI (1%-100%) LV1 =Low-voltage dimming driver (0-100%) STP =Step Dimming (Bi-Level, 50%) LH =Lutron HiLume 1% EcoSystems (LDE1) W2A =White Tuning, 2ch, 0-10V Intensity and CCT control	[Blank] =No Sensor	[Blank] =No Emergency EL7W =7-watt 120V-277V Integral EM Battery EL14W =14-watt 120V-277V Integral EM Battery ETRD =Iota Emergency Transfer Relay with dimming control	[Blank] =None CP =Chicago Plenum W6 =3/8" Flex Installed, A3/8-4/18GDIM
Notes EQ Grid Clips are recommended for all 9/16" ceiling systems. Four required per fixture. See Accessories for ordering details.	Notes VividTune W2A driver option not available with 48L or 60L lumen packages. Consult DLVP system pages for additional details and compatibility.	Notes	Notes	Notes Battery option increases total height by 1 inch. ETRD used to bypass local control during outage; must be used in conjunction with UL 1008 device (provided by others); must specify voltage as 120V or 277V when ordering. 347V not available.	Notes See specification features for flexible metal conduit details.

Product Specifications

Construction

- 2-1/4" housing depth constructed of die-formed, code gauge cold rolled steel
- Full length die-formed stiffeners and unibody endplate for added strength
- Back reflector is 90% reflective matte white using electrostatically applied polyester powder coat paint for durability and luminous uniformity

Shielding

- Smooth opal acrylic lens with round (R) or flat (Z) profile
- Provides low-glare ambient illumination with evenly luminous side reflectors
- Lens secured to housing via injection molded ends for easy tool-free access

Mounting

- Endplates provided with Grid-Lock feature for safety
- Optional earthquake clips available
- Four auxiliary fixture end suspension points
- Consult local code for appropriate tie-wire recommendations
- See Accessories section for drywall frame kit and surface mount kit options

LED and Light Engine

- LED's are available in 3000K, 3500K, 4000K
- Dynamic tunable white options available with Cooper Lighting Solutions' VividTune
- CRI options of either ≥80CRI or ≥90CRI

- Lumen output will be affected - please refer to the lumen adjustment factor tables
- TM21 life at 60,000 hours up to L94 and calculated L70 exceeds 290,000 hrs
- Drivers available in 120-277V and 347V

Integrated Controls

- 0-10V dimming to 1% standard
- Low-voltage driver compatible for DLVP applications
- DALI 2.0, Lutron, and step-dimming available

Emergency Options

- Optional 120-277V emergency battery available in 7W or 14W
- 90-minute backup period for code compliance
- Test switch with laser pointer and testing from floor feature for ease of use
- EZ Key feature prevents accidental discharge during construction
- For approximate delivered lumens multiply the lumens per watt of the desired fixture by the wattage of the emergency battery pack (100 lm/W x 14 = 1400 lumens)
- UL 924 emergency/generator transfer options available

Flexible Metal Conduit Options

- Flex options available for 0-10V dimming control, DALI dimming control, emergency and night light functions

- 72-inch factory-installed and pre-wired to driver, fitted to luminaire housing access plate with 90° enclosed FMC connector
- Default flex option is A3/8-4/18GDIM; 3/8" flexible metal conduit with 2-#18 power and ground wires and 2-#18 UL-listed jacketed 0-10V +/- control wires
- Not all options may be combined and installation rating vary by type

Weight

- 11.0 lbs.

Compliance

- IC rated for insulation contact
- cULus listed for damp locations
- RoHS compliant
- Tested to IESNA LM-79 and LM-80
- Stated life per TM21 standards
- Can be used for State of California Title 24 high efficacy luminaire

Warranty

- Five year warranty standard. Optional ten year warranty available.

Photometric Data

[View IES files](#)

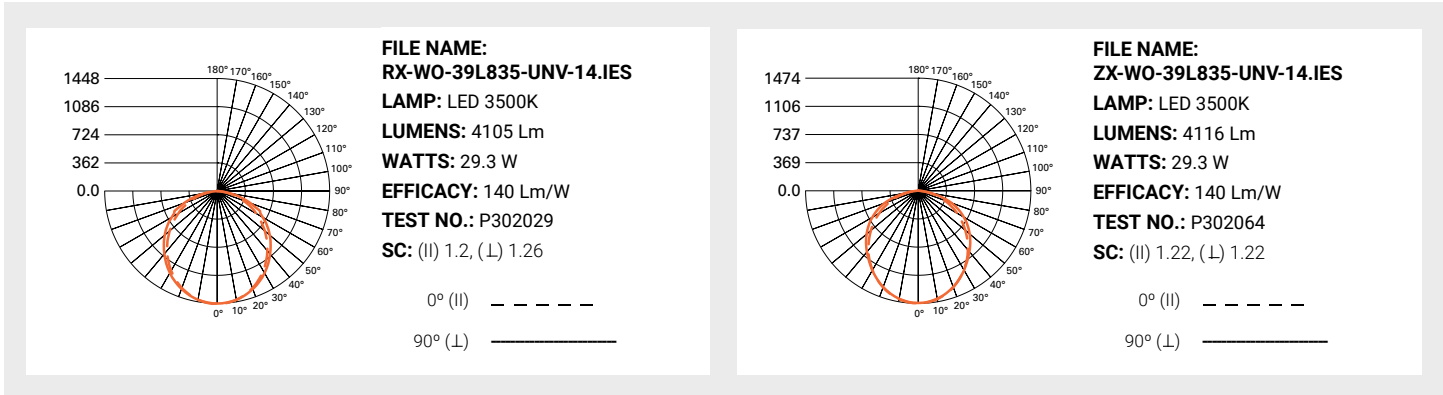

Note: Refer to IES files for more product data.

Energy and Performance Data

1x4 – RX Light Level Outputs (3500K, 80 CRI)				
Series	Lumen Package	Delivered Lumens	Wattage	Efficacy (LPW)
RX-WO Round	20L	2078	16.0	130
	29L	2980	24.3	123
	39L	4105	29.3	140
	44L	4670	38.3	122
	48L	4993	36.9	135
	60L	6233	48.3	129
ZX-WO Flat	20L	2084	16.0	130
	29L	2989	24.3	123
	39L	4116	29.3	140
	44L	4683	38.3	122
	48L	5007	36.9	136
	60L	6251	48.3	129

Lumen Adjustment Factors

CCT	80 CRI	90 CRI
3000K	0.981	0.806
3500K	1.000	0.836
4000K	1.021	0.853

Example Calculation:

ZX / 39L / 3500K / 80 CRI

Lumen Output selected = 4116 lms

3500K / 90 CRI Desired

Lumen Adjustment Factor = 0.836

Adjusted Lumen Output = 4116 lms x 0.836 = 3441 lms

Lumen Maintenance

Ambient Temperature	TM-21 Lumen Maintenance (60,000 hours)	Theoretical L70 (Hours)
25°C	>94%	290,000

Color Data (3500K)

		80CRI	90CRI
TM-30-15	R _f	82.4	90.8
	R _g	95.2	99.5
CRI/CIE	R _a	82.7	95.7
	R _g	6.3	65.9

Ceiling Compatibility

Grid/Lay-in Flush

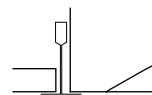

Concealed T

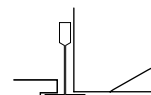

Slot Grid

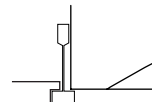

9/16" Tegalum*

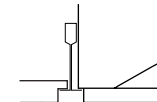

*Requires T9T ceiling type option

Shielding Options



Round Opal Lens (RX-WO)



Flat Opal Lens (ZX-WO)

Accessories (Ordered Separately)

CZ2-EQCLIP-U = T-BAR Safety Earthquake Clip Kit (4 clips per bag kit)

DF-14-W = 1' x 4' Drywall Frame Kit

SK-14-WT = 1' x 4' Field Install Surface Mount Kit, Tall



Class RX with VividTune Tunable White

VividTune tunable white luminaires from Cooper Lighting Solutions deliver high-quality light in a broad range of continuously variable color temperatures and intensities. Create a dynamic environment by adjusting the ambient light warmer or cooler to influence mood, support the task at hand, or create a dramatic ambience. The ability to control correlated color temperature and intensity separately using simple controls is the next evolution of LED lighting for the commercial, educational, healthcare and hospitality space. The unparalleled flexibility and number of available lighting environments enable users to find the right light with tunable white.

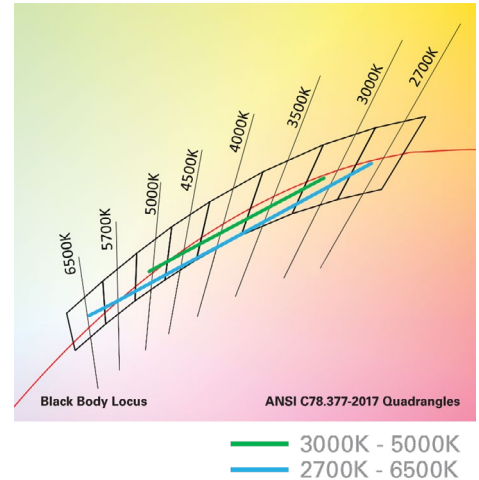

Energy and Performance Data

Tunable White - Lumen Adjustment Factors				
CCT	3000K-5000K		2700K-6500K	
	80 CRI	90 CRI	80 CRI	90 CRI
2700K	-	-	0.903	0.771
3000K	0.929	0.765	0.928	0.801
3500K	0.983	0.836	0.961	0.842
4000K	1.033	0.903	0.981	0.868
4500K	1.042	0.918	0.999	0.891
5000K	1.042	0.918	1.013	0.909
6500K	-	-	1.028	0.933

1'x 4' Class RX LED - Example of Approximate Lumen Calculation			
	Standard Catalog #	VividTune 80 CRI Catalog #	VividTune 90 CRI Catalog #
CCT Setting	RX-WO-39L835-UNV-24-STD	RX-WO-39L83050-UNV-24-W2A	RX-WO-39L93050-UNV-24-W2A
3000K	-	3814	3140
3500K	4105	4035	3432
4000K	-	4240	3707
4500K	-	4277	3768
5000K	-	4277	3768

Controlling VividTune Tunable White

VividTune luminaires make tunable white more accessible by using simple and familiar controls. From wall dimmers to wireless controls, VividTune tunable white luminaires are compatible with industry standard 0-10V dimming controls. A single 0-10V dimming input is used to control intensity (brightness) while a second 0-10V dimming input is used to adjust CCT.

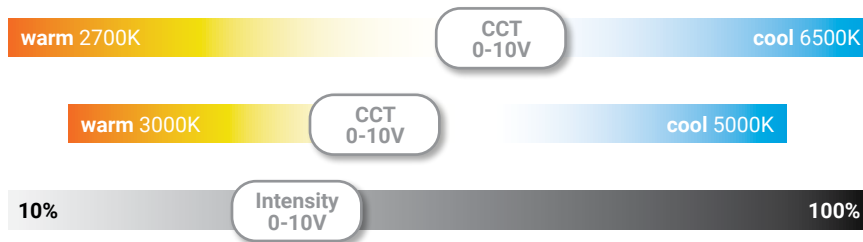

Example of Lumen Adjustment Calculation

RX-WO-55H83050-UNV-STD-14
at 80 CRI tuned to 3500K

$Adjusted\ Lumen = published\ lm \times adjusted\ lm\ factor$

$Adjusted\ Lumen = 4105 \times 0.983$

$Adjusted\ Lumen = 4035$

* Lumen adjustment factors are for reference and may be different for each product selected. Refer to IES files for actual performance data on each.