

Project		Catalog #		Type	
Prepared by		Notes		Date	



# Lumark

## LAS

Area / Site Luminaire

### Product Features



### Product Certifications

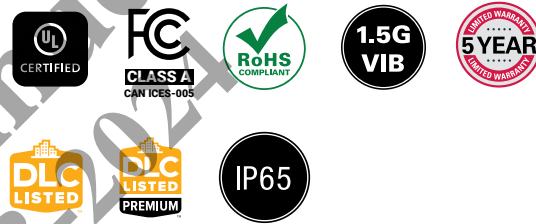

### Interactive Menu

- Stock Ordering Information page 2
- Ordering Information page 2
- Product Specifications page 2
- Mounting Details page 3
- Energy and Performance Data page 3
- Controls Options page 4

### Quick Facts

- 10-position lumen selectable across 2 housing sizes
- Lumen packages range from 4,900 - 34,000 lumens (30W - 250W)
- Replaces up to 450W and 1,000W HID equivalent
- Efficacies up to 135 lumens per watt at maximum output
- Energy and maintenance savings up to 79% versus HID solutions

### Dimensional Details

LAS45 - Pole Mount

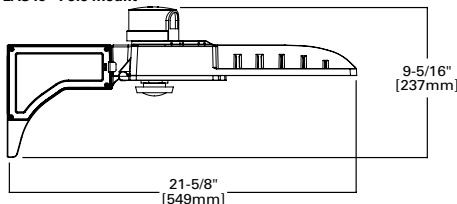

LAS45

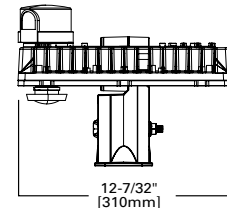
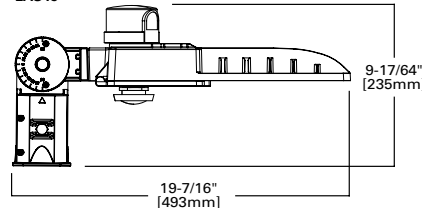

LAS100 - Pole Mount

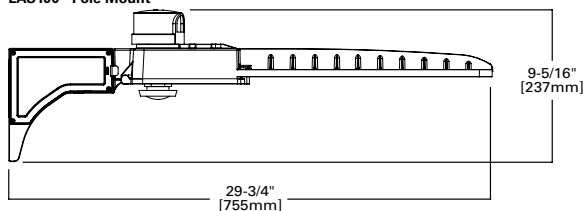

LAS100

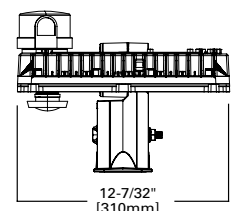
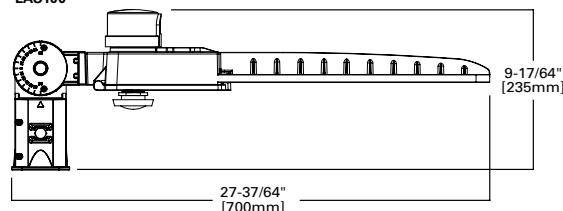

## Stock Ordering Information

SAMPLE NUMBER: **LAS45S-T4**

Model Number <sup>1</sup>		Distribution	Voltage
LAS45P=Pole Mount Arm, 450W HID Equivalent LAS45S=Slipfitter Mount, 450W HID Equivalent	LAS100P=Pole Mount Arm, 1,000W HID Equivalent LAS100S=Slipfitter Mount, 1,000W HID Equivalent	T3=Type III T4=Type IV	T5=Type V  [Blank]=Universal, 120-277V HV=High Voltage, 347-480V <sup>2</sup>
<b>NOTES:</b> 1. DesignLights Consortium® Qualified. Refer to <a href="http://www.designlights.org">www.designlights.org</a> Qualified Products List under Family Models for details. 2. Supplied with shoring cap. Use NEMA 3-PIN twistlock photocontrol that matches the input voltage used (either 347V or 480V) as desired.			

## Ordering Information

SAMPLE NUMBER: **LAS45S-T4-MS/DIM-L40W**

Model Number <sup>1,2</sup>	Distribution	Voltage	Options	Accessories (Order Separately)
LAS45P=Pole Mount Arm, 450W HID Equivalent LAS45S=Slipfitter Mount, 450W HID Equivalent LAS100P=Pole Mount Arm, 1,000W HID Equivalent LAS100S=Slipfitter Mount, 1,000W HID Equivalent	T3=Type III T4=Type IV T5=Type V	[Blank]=Universal, 120-277V HV=High Voltage, 347-480V <sup>3</sup>	MS/DIM-L40W=Motion Sensor for Dimming Operation, 21' - 40' Mounting Height	FSIR-100=Wireless Configuration Tool for Motion Sensor <sup>4</sup> RABBZ=Wall Mount Tenon Adapter RABX-BZ=Pole Mount Tenon Adapter
<b>NOTES:</b> 1. DesignLights Consortium® Qualified. Refer to <a href="http://www.designlights.org">www.designlights.org</a> Qualified Products List under Family Models for details. 2. Standard lead times apply. Sensor versions do not include lumen select switch. Max light output can be field-programmed via the motion sensor with the accessory configuration tool. 3. Supplied with shoring cap. Use NEMA 3-PIN twistlock receptacle photocontrol that matches the input voltage used (either 347V or 480V) as desired. 4. This tool enables adjustment to Motion Sensor (MS) parameters including high and low modes, sensitivity, time delay, cutoff and more. Consult your lighting representative for more information.				

## Product Specifications

### Construction

- Die-cast aluminum housing with hinged, die-cast aluminum door
- Pole mount arm mounts directly to minimum 4 inch round or square poles (recommended Type N drill pattern)
- Slipfitter mounts 2-3/8" vertical or horizontal tenons; Downward facing only
- IP65 rated housing enclosure
- 10-position lumen select switch accessible via hinged housing door

### Optics

- UV-resistant polycarbonate optics
- Full cutoff when mounted at 0 degrees tilt
- 4000K CCT, 70CRI
- IP66 optical enclosures

### Controls

- 10-position lumen selectable. Internal toggle switch for adjusting luminaire lumens.
- Lumen packages range from 4,900 up to 34,000 lumens (30W - 250W). Default settings for selectable luminaires are maximum lumen output.
- Integrated button-type photocontrol is included for dusk-to-dawn operation.
- To disable the photocontrol, place the provided cap over the sensor.

### Electrical

- 40°C minimum operating temperature
- 40°C maximum operating temperature
- >0.9 power factor
- <20% total harmonic distortion
- Class P drivers incorporate internal MOVs designed to withstand 6kV of surge
- 0-10V dimming driver is standard
- 3-PIN NEMA twistlock photocontrol receptacle and photocontrol included (UNV configurations)

### Finish

- Standard color is bronze
- Finish only warrantied for a period of 1 year

### Shipping Data

- LAS45S / LAS45P: 14.0 lbs. (6.4 kgs.)
- LAS100SS / LAS100P: 18.0 lbs. (8.2 kgs.)

### Warranty

- Five year limited warranty, consult website for details. [www.cooperlighting.com/legal](http://www.cooperlighting.com/legal)

Mounting Details

Mounting Configurations and EPAs

Housing Size	Mounting	Tilt							
			1	2 @ 90°	2 @ 120°	2 @ 180°	3 @ 90°	3 @ 120°	4 @ 90°
LAS45	Slipfitter	0°	0.488	0.772	1.110	0.973	1.258	1.320	1.262
LAS45	Slipfitter	10°	0.488	0.854	1.217	0.975	1.305	1.532	1.307
LAS45	Slipfitter	20°	0.488	1.158	1.440	0.977	1.644	2.102	1.646
LAS45	Slipfitter	30°	0.488	1.413	1.661	0.972	1.892	2.582	1.896
LAS45	Slipfitter	45°	0.488	1.733	1.972	0.974	2.220	3.208	2.224
LAS45	Pole Mount	N/A	0.560	0.930	1.090	1.120	1.400	1.440	1.460
LAS100	Slipfitter	0°	0.604	0.888	1.237	1.208	1.489	1.521	1.492
LAS100	Slipfitter	10°	0.604	1.171	1.541	1.204	1.765	2.100	1.765
LAS100	Slipfitter	20°	0.604	1.597	1.920	1.202	2.191	2.908	2.195
LAS100	Slipfitter	30°	0.603	1.996	2.290	1.204	2.591	3.670	2.595
LAS100	Slipfitter	45°	0.603	2.478	2.776	1.201	3.070	4.651	4.375
LAS100	Pole Mount	N/A	0.670	1.030	1.250	1.340	1.610	1.610	1.660

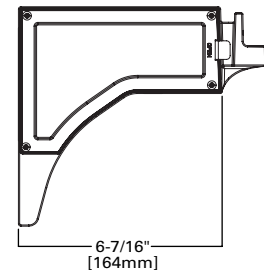
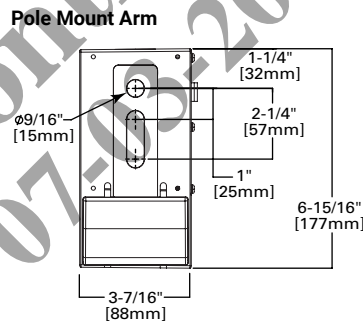
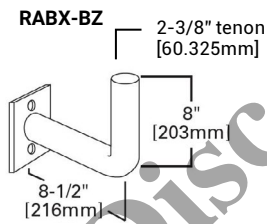
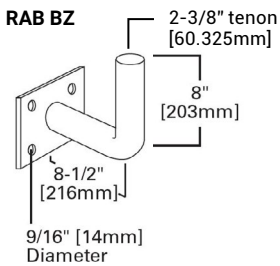

Round Pole Mount

Type "N" Drill Pattern

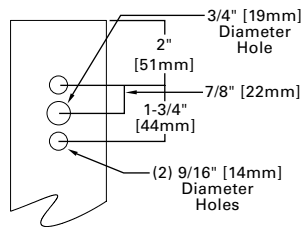
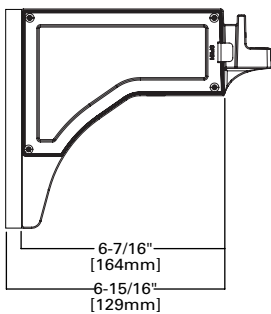

Energy and Performance Data

Lumen Maintenance

Ambient Temperature	TM-21 Lumen Maintenance (54,000 Hours)	Theoretical L70 (Hours)
Up to 40°C	85.80%	126,000

Energy and Performance Data (cont.)

[View LAS IES files](#)

Power and Lumens (LAS45)

Lumen Select Switch	Position 0 (Factory Preset)	1	2	3	4	5	6	7	8	9	
Power (Watts)	152.7	135.4	119.7	99.2	89.5	79.2	75.2	68.8	29.3	29.3	
Input Current @ 120V (A)	1.27	1.13	1.00	0.83	0.75	0.66	0.63	0.57	0.27	0.27	
Input Current @ 277V (A)	0.58	0.53	0.48	0.42	0.39	0.36	0.34	0.32	0.19	0.19	
Input Current @ 347V (A)	0.45	0.40	0.36	0.30	0.27	0.24	0.23	0.21	0.10	0.10	
Input Current @ 480V (A)	0.33	0.30	0.27	0.23	0.21	0.19	0.19	0.17	0.09	0.09	
<b>Distribution</b>											
T3 (Type III)	Lumens	20,089	18,434	16,810	14,515	13,360	12,083	11,550	10,705	4,901	4,901
	BUG Rating <sup>1</sup>	B3-U0-G3	B3-U0-G3	B3-U0-G3	B3-U0-G3	B3-U0-G3	B3-U0-G3	B3-U0-G3	B2-U0-G2	B1-U0-G1	B1-U0-G1
	Lumens per Watt	132	136	140	146	149	153	154	156	167	167
T4 (Type IV)	Lumens	19,720	18,095	16,502	14,249	13,115	11,862	11,338	10,509	4,811	4,811
	BUG Rating <sup>1</sup>	B3-U0-G3	B3-U0-G3	B3-U0-G3	B3-U0-G3	B3-U0-G3	B2-U0-G3	B2-U0-G3	B2-U0-G3	B1-U0-G2	B1-U0-G2
	Lumens per Watt	129	134	138	144	147	150	151	153	164	164
T5 (Type V)	Lumens	19,956	18,311	16,698	14,418	13,271	12,003	11,473	10,634	4,868	4,868
	BUG Rating <sup>1</sup>	B3-U0-G3	B4-U0-G2	B4-U0-G2	B3-U0-G2	B3-U0-G2	B3-U0-G2	B3-U0-G1	B3-U0-G1	B2-U0-G1	B2-U0-G1
	Lumens per Watt	131	135	139	145	148	152	153	155	166	166

**NOTES:**  
1. All BUG Ratings reported with fixture oriented at 0 degrees.

Power and Lumens (LAS100)

Lumen Select Switch	Position 0 (Factory Preset)	1	2	3	4	5	6	7	8	9	
Power (Watts)	251.0	222.2	196.4	162.8	146.8	129.9	123.4	112.9	48.0	48.0	
Input Current @ 120V (A)	2.09	1.86	1.64	1.36	1.23	1.09	1.03	0.95	0.41	0.41	
Input Current @ 277V (A)	0.90	0.82	0.73	0.62	0.57	0.52	0.50	0.46	0.28	0.28	
Input Current @ 347V (A)	0.74	0.66	0.59	0.49	0.44	0.40	0.38	0.34	0.15	0.15	
Input Current @ 480V (A)	0.55	0.49	0.44	0.37	0.34	0.30	0.29	0.27	0.13	0.13	
<b>Distribution</b>											
T3 (Type III)	Lumens	33,965	31,166	28,421	24,541	22,588	20,429	19,527	18,100	8,286	8,286
	BUG Rating <sup>1</sup>	B4-U0-G4	B4-U0-G4	B4-U0-G4	B3-U0-G3	B3-U0-G3	B3-U0-G3	B3-U0-G3	B3-U0-G3	B2-U0-G2	B2-U0-G2
	Lumens per Watt	135	140	145	151	154	157	158	160	173	173
T4 (Type IV)	Lumens	33,342	30,594	27,900	24,090	22,174	20,055	19,169	17,768	8,134	8,134
	BUG Rating <sup>1</sup>	B4-U0-G4	B3-U0-G4	B3-U0-G4	B3-U0-G4	B3-U0-G3	B3-U0-G3	B3-U0-G3	B3-U0-G3	B2-U0-G2	B2-U0-G2
	Lumens per Watt	133	138	142	148	151	154	155	157	169	169
T5 (Type V)	Lumens	33,740	30,959	28,232	24,378	22,438	20,294	19,398	17,980	8,231	8,231
	BUG Rating <sup>1</sup>	B5-U0-G3	B5-U0-G3	B4-U0-G2	B4-U0-G2	B4-U0-G2	B4-U0-G2	B4-U0-G2	B4-U0-G2	B3-U0-G1	B3-U0-G1
	Lumens per Watt	134	139	144	150	153	156	157	159	171	171

**NOTES:**  
1. All BUG Ratings reported with fixture oriented at 0 degrees.

Control Options

Dimming Occupancy Sensor (MS)

These sensors are factory installed in the luminaire housing. When a sensor for dimming operation (/DIM) option is selected, the luminaire will dim down to approximately 50 percent power after five minutes of no activity detected. When activity is detected, the luminaire returns to full light output. These occupancy sensors include an integral photocell that can be activated or inactivated with the programming remote / configuration tool for "dusk-to-dawn" control or "daylight harvesting". Note: For MS sensors, the factory preset is OFF (Disabled). The programming remote / tool is a wireless tool that can be utilized to change the dimming level, time delay, sensitivity and other parameters. The sensor lens optimizes the coverage pattern for mounting heights from 21'-40'.

