

Project		Catalog #		Type	
Prepared by		Notes		Date	

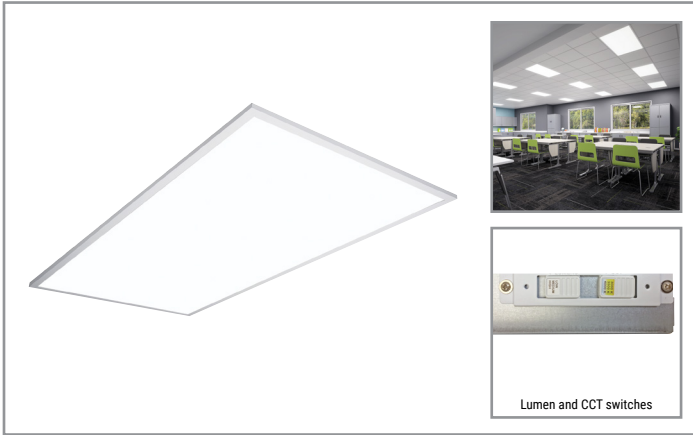

Metalux

FPS LED

LED Edge Lit Panel with Selectable Lumens and CCT

Typical Applications

• Offices • Education • Healthcare • Retail

Interactive Menu

- Order Information [page 2](#)
- Photometric Data [page 3](#)
- Product Warranty

Top Product Features

- Ultra-thin approx. 2 inch height fits in shallow plenums with room to spare
- Simple switch to adjust lumens, watts and CCT on site as desired
- Switch tamper cover included
- Projected lumen maintenance based on TM21 testing standards is L87 > 60,000 hours
- 1x4, 2x2, and 2x4 sizes available, all rated for direct insulation contact (IC rated)

Product Certification

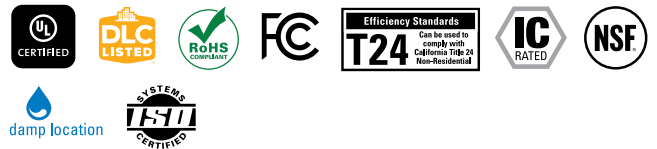

Product Features



2' x 2'

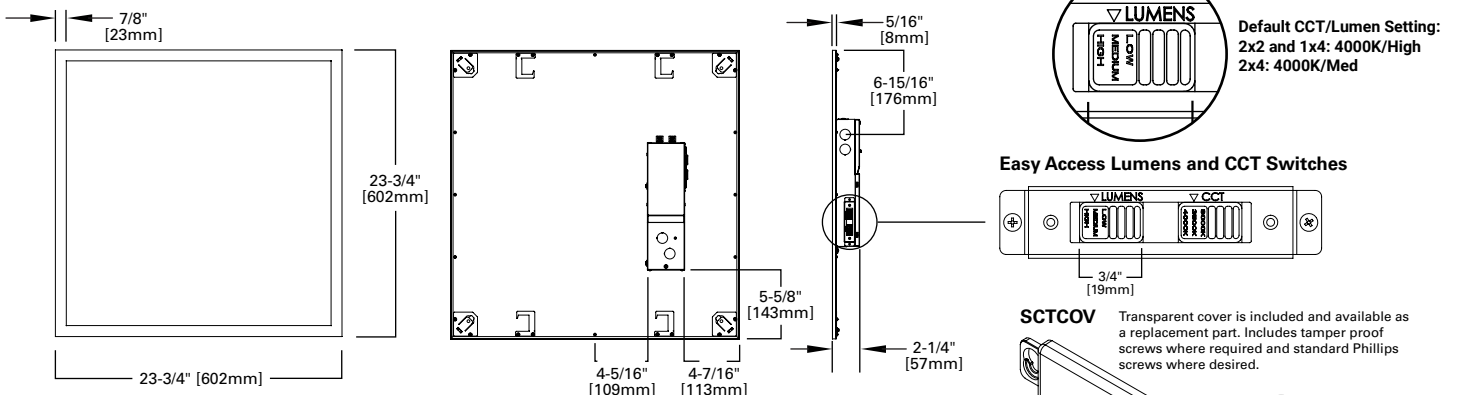

Default CCT/Lumen Setting:
2x2 and 1x4: 4000K/High
2x4: 4000K/Med

Easy Access Lumens and CCT Switches

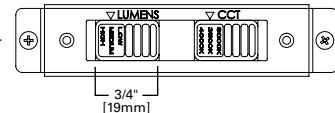

SCTCOV

Transparent cover is included and available as a replacement part. Includes tamper proof screws where required and standard Phillips screws where desired.

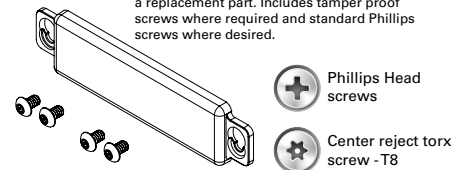

Also available in 1' x 4' and 2' x 4'

[additional product diagrams](#)

Ordering Information/Performance

Default CCT/Lumen Setting: 2x2 and 1x4: 4000K/High
2x4: 4000K/Med

		Low	Medium	High
24FPSL2SCT3	4000K	27.2W 3180lm 117LPW	40.2W 4620lm 115LPW	56.3W 6300lm 112LPW
	3500K	27.2W 3150lm 116LPW	40.2W 4550lm 113LPW	56.3W 6250lm 111LPW
	3000K	27.2W 3100lm 114LPW	40.2W 4500lm 112LPW	56.3W 6200lm 110LPW
14FPSL1SCT3	4000K	18W 2070lm 115LPW	27W 3100lm 115LPW	36.3W 4100lm 113LPW
	3500K	18W 2040lm 113LPW	27W 3050lm 113LPW	36.3W 4050lm 111LPW
	3000K	18W 2000lm 112LPW	27W 3000lm 111LPW	36.3W 4000lm 110LPW
22FPSL2SCT3	4000K	15.2W 1750lm 115LPW	21.6W 2460lm 114LPW	31W 3500lm 113LPW
	3500K	15.2W 1720lm 113LPW	21.6W 2420lm 112LPW	31W 3440lm 111LPW
	3000K	15.2W 1700lm 112LPW	21.6W 2400lm 111LPW	31W 3400lm 110LPW

Options

Catalog	Description	Example	Notes
EL7W ⁽¹⁾	7W EM Pack, Installed	24FPSL2SCT3-EL7W	Remote Indicator/Test Switch
EL10W ⁽¹⁾	10W EM Pack, Installed	24FPSL2SCT3-EL10W	Remote Indicator/Test Switch
EL14W ⁽¹⁾	14W EM Pack, Installed	24FPSL2SCT3-EL14W	Remote Indicator/Test Switch
A3/8-4/18GDIM	6' Length, 3/8" Cable, 2 Wire, 2 Dimming Leads, Ground	24FPSL2SCT3-A3/8-4/18G DIM	

Notes: (1) Factory installed with remote test switch/indicator/laser test. For approximate delivered lumens multiply the lumens per watt of the desired fixture by the wattage of the emergency battery pack (100 lm/W x 7=700 lumens). IES-format photometry for luminaire under emergency operation available. Battery option increases total height by 1 inch.

Shipping Data

Fixture Size	Pallet Size	Units per Pallet
1' x 4'	52" x 49"	48
2' x 2'	53" x 49"	40
2' x 4'	53" x 49"	20

Regress Frame Ordering Information

Field Assembly Kit

Regress Mount Kit

Catalog No.	Description	UPC	Size
RMK2-14-W	1x4 Regress Mount Kit	080083288021	1x4
RMK2-22-W	2x2 Regress Mount Kit	080083287185	2x2
RMK2-24-W	2x4 Regress Mount Kit	080083288007	2x4

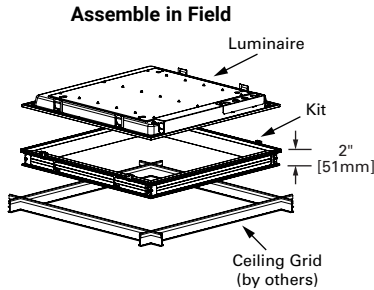

Factory Installed with Luminaire

Catalog	Description	Example
-RMK2	1x4, 2x2 or 2x4 assembled together with luminaire. Ships as one unit – Regress frame and Fixture	22FPSL2SCT3-RMK2

Ships Complete - Ready to Install

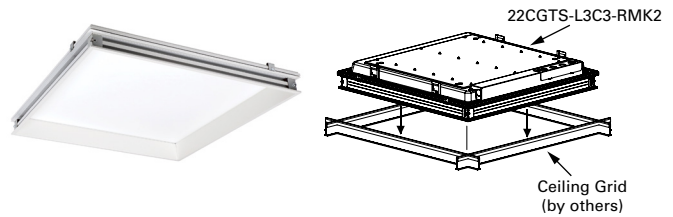

Accessories

Drywall Frame Kit

Catalog	UPC	Size
DF-24W-U	662401232970	2x4
DF-22W-U	662401232963	2x2
DF-14W-U	662401232949	1x4

Surface Mount Kit

Catalog	UPC	Size
FPXSURF24	080083867400	2x4
FPXSURF22	080083867387	2x2
FPXSURF14	080083867424	1x4

Note: Use surface kit to suspend 2x4 and 1x4.

SCTCOV

Transparent cover is included and available as a replacement part. Includes tamper proof screws where required and standard Phillips screws where desired.

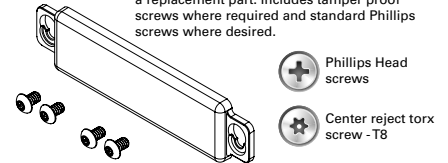

Ceiling Retention

Catalog	UPC
FPEQ	080083802685

Required by some local codes. Order one set for each fixture (Four clips per kit)

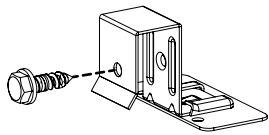

Suspension Kit

Catalog	UPC
FPSUS24-B	080083876686
FPSUS24	080083258895

Mounting height from ceiling
Min. = 7-1/4" [184mm]
Max. = 27" [286mm]

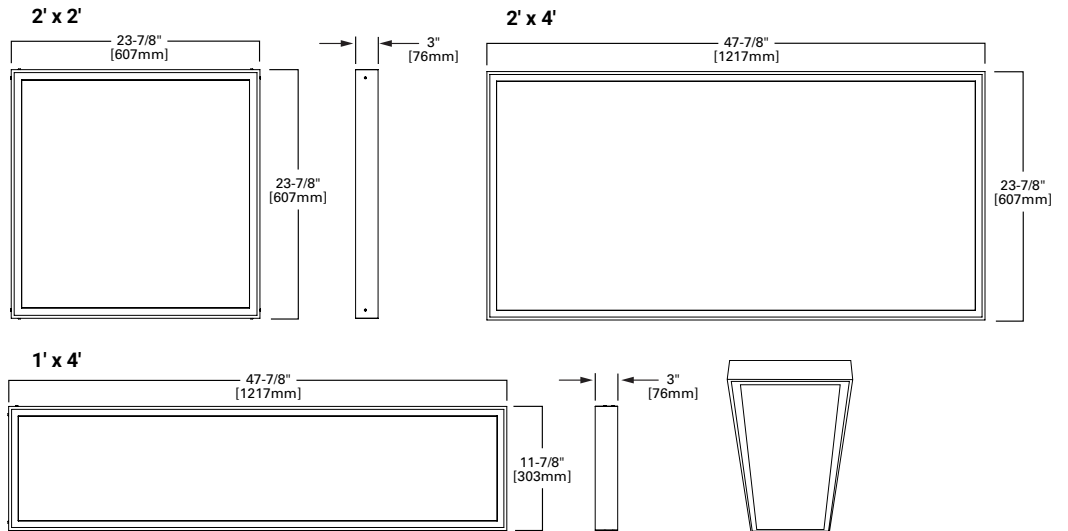
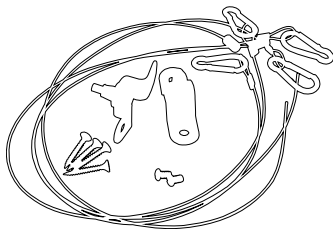

Product Specifications

Construction

- Narrow aluminum bezel is tightly held to code gauge steel back plate
- Seamless corners to maximize the light emitting surface with a refined finish

Mounting

- Integral grid clips and separate suspension clips provided for installation flexibility
- Junction box constructed of code gauge galvanized steel with an easy access hinged door
- Multiple Trade size KO provided and JBox is suitable for up to 12AWG wiring
- Topside KO for use with MWS
- Stock luminaire is less than 2 inches for use in shallow plenum or low ceiling spaces
- Surface or suspension mounting kits available. Direct suspension of 2x2 only. 2x4 and 1x4 suspend with the surface mount kit.
- Factory installed flexible cable with dimming leads options available

Warranty

- Five-year limited warranty.

Controls

- Standard UNV 120-277V driver with 0-10V dimming to 10% standard
- Compatible with field installed wireless controls available for either Wavelinx or LumaWatt Pro

Electrical

- 3000K/3500K/4000K at minimum 80 CRI and three lumen options
- Projected lumen maintenance based on TM21 testing standards is L87 > 60,000 hours
- Complies with FCC Class B rating for use in residential spaces
- Installed Flex options available

Optical Shielding

- Light guide with specialized features to optimize light extraction
- White frost lens with smooth pattern for uniform illumination
- Scratch and impact resistant lens

Regress Frame

- Factory installed option available for ship complete, single unit to speed install. See fixture ordering logic
- Fits CGTS, CGT, FPS, and FP. Consult factory for additional luminaire choices
- Extruded aluminum frame with miter corners at 2" nominal height
- Regress kit does not alter design or construction of luminaire
- Accessory kit also available

Compliance

- Indoor luminaires are cULus listed for 25C ambient environments
- IC rated for direct insulation contact
- RoHS compliant
- Damp location listed
- IESNA LM-79 and LM-80 standards compliant
- DesignLights Consortium qualified and classified for DLC Standard
- Meets IP5X rating from the room side with no modification needed
- Fixture is rated for NSF/ANSI standard 2 - Light fixture for Splash Zone and Non-Food Zone

Emergency Battery Options

- 120V-277V integral emergency battery pack comes in 7-watts, 10-watt, or 14-watts
- Constant power to the LED system for controlled, predictable discharge
- Remote test switch/indicator light
- Min. 90-minute backup period for code compliance

Photometric Data

[View IES files](#)

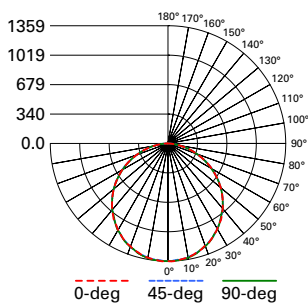

14FPSL2SCT3-3500K-HI
Electronic Driver
Linear LED 3500K
Spacing criterion: (H) 1.25 x mounting height, (L) 1.25 x mounting height
Lumens: 3883
Input Watts: 36.3W
Efficacy: 107.0 LPW
Test Report: 14FPSL2SCT3-3500K-HI.IES

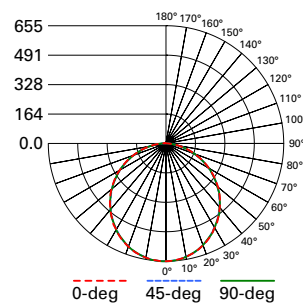

22FPSL2SCT3-3500K-LOW
Electronic Driver
Linear LED 3500K
Spacing criterion: (H) 1.25 x mounting height, (L) 1.24 x mounting height
Lumens: 1864
Input Watts: 16W
Efficacy: 116.5LPW
Test Report: 22FPSL2SCT3-3500K-LOW.IES

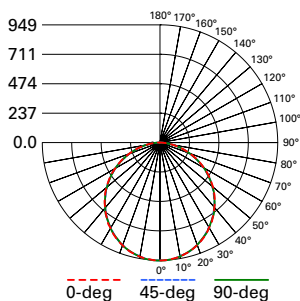

22FPSL2SCT3-3500K-MID
Electronic Driver
Linear LED 3500K
Spacing criterion: (H) 1.25 x mounting height, (L) 1.24 x mounting height
Lumens: 2694
Input Watts: 24.1W
Efficacy: 111.8 LPW
Test Report: 22FPSL2SCT3-3500K-MID.IES

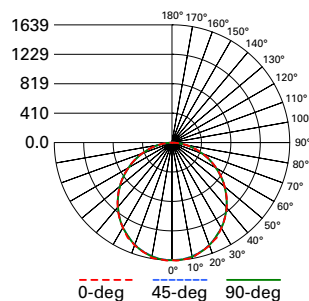

24FPSL2SCT3-3500K-MID
Electronic Driver
Linear LED 3500K
Spacing criterion: (H) 1.24 x mounting height, (L) 1.24 x mounting height
Lumens: 4642
Input Watts: 41.5W
Efficacy: 111.9 LPW
Test Report: 24FPSL2SCT3-3500K-MID.IES

Dimensional and Mounting Details

2' x 2'

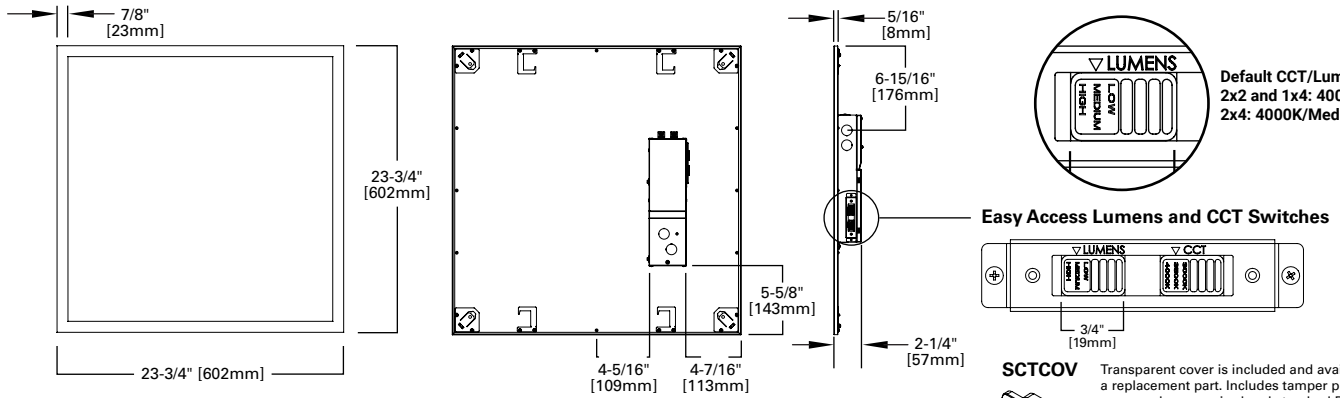

2' x 4'

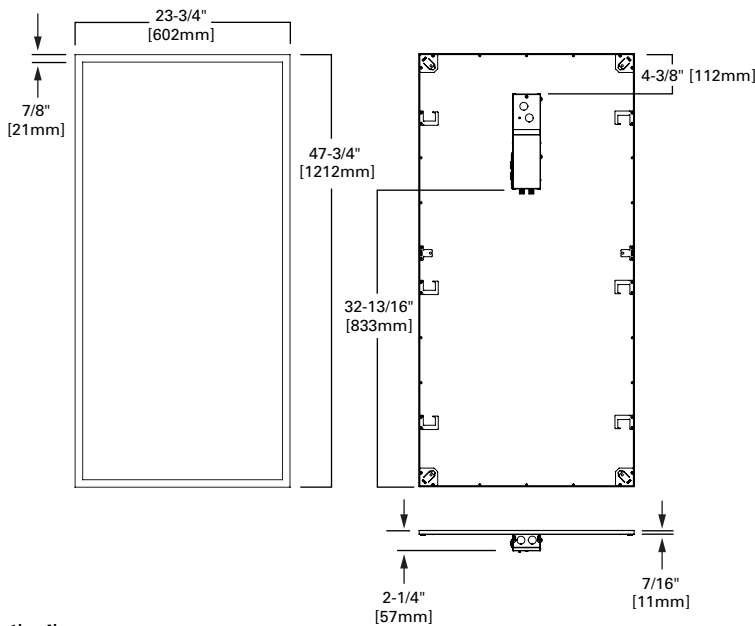

1' x 4'

