

Project		Catalog #		Type	
Prepared by		Notes		Date	



# Portfolio

## LDA6A 6L

6-Inch Adjustable Slope Wall Wash  
New Construction  
1000-7000 Lumens

### Typical Applications

Healthcare • Hospitality • Retail • Institutional • Indoor Display & Signage

### Interactive Menu

- Order Information [page 2](#)
- Product Specifications [page 3](#)
- Energy & Performance Data [page 3](#)
- Photometric Data [page 4](#)
- Connected Systems [page 6](#)
- Product Warranty



### Top Product Features

- Adjustable accent/slope or lensed wall wash (flat or sloped ceilings)
- Excellent light control and low aperture brightness
- Lockable 365° rotation and 45° tilt holds any aiming position
- Round spun aluminum reflectors, Holds 2 lens media
- 4 color temperatures: 2700K, 3000K, 3500K and 4000K CCT
- CRI: 80 or 90, D2W™ option from 3000K to 1850K
- Angle cut, lensed wall wash, lensed and flat cut downlight reflectors
- Lumens: 1,000-7,500
- Options to meet Trade Agreements Act requirements

### Dimensional and Mounting Details

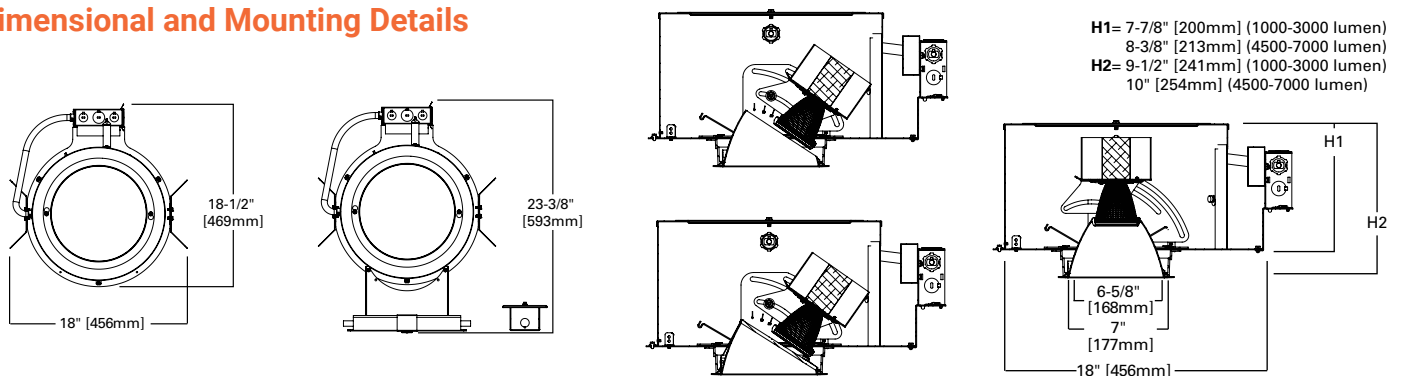

Order Information

SAMPLE ORDER NUMBER: **LDA4A09835D010TE**

Domestic Preferences <sup>(14)</sup>	Housing	Lumens <sup>(1)</sup>	CRI	CCT	Driver	Options <sup>(9)(16)</sup>
[Blank]=Standard TAA=Trade Agreements Act	LDA6A=6" Aperture adjustable/slope LDA6ACP=6" Aperture adjustable/slope,Chicago Plenum	10=1000 (IC Rated) 15=1500 (IC Rated) 20=2000 (IC Rated) 30=3000 (Non IC) <sup>(5)</sup> 45=4500 (Non IC) <sup>(5)(7)</sup> 55=5500 (Non IC) <sup>(5)(7)</sup> 65=6500 (Non IC) <sup>(5)(7)</sup> 75=7500 (Non IC) <sup>(5)(7)</sup>	8=80 CRI 9=90 CRI	27=2700K 30=3000K 35=3500K 40=4000K 30D2W= Dim to warm - 3000K to 1850K (1800 lumen and below, 90 CRI) <sup>(8)</sup>	<b>1000, 1500, 2000, 3000 and 4500 Lumen</b> D010TE=120-277V 0-10V 1% dimming or trailing edge 120V Dimming <b>1000, 1500, 2000 and 3000 Lumen</b> D010TR=120-277V 0-10V 1% dimming or leading edge 120V Dimming D5LT=Fifth Light® DALI DT6 Logarithmic Dimming, 0% to 100%, 120V-277V DE010=0-10V Linear Dimming, 0% to 100%, 120V-277V DMX=DMX/RDM Logarithmic Dimming, 0% to 100%, 120V-277V <sup>(10)</sup> DMXC5=DMX/RDM Logarithmic Dimming, 0% to 100%, 120V-277V, with RJ45 connection <b>5500, 6500, and 7500 Lumen</b> D010=120-277V, 0-10V 10% Dimming	EMBOD=7W Bodine® Emergency Module with Remote Test Switch EMBOD7ST=Bodine® Emergency Module with Self Test Remote Test Switch EM7=7W Emergency Module with Remote Test Switch EM14=14W Emergency Module with Remote Test Switch WPN = WaveLinX PRO Wireless Node without sensor <sup>(16)</sup> WLN = WaveLinX LITE Wireless Node without sensor <sup>(17)</sup>

SAMPLE ORDER NUMBER: **LARL20NF**

Beam Forming Reflector	
<b>1000 to 3000 lumen</b> LARL15SP=15° Reflector LARL20NF=20° Reflector LAR35FL=35° Reflector	<b>4500 to 7500 lumen</b> LARH20SP=20° Reflector LARH30NF=30° Reflector LARH40FL=40° Reflector

SAMPLE ORDER NUMBER: **6LA1LI**

Reflector	Finish		Options
6LA0=6" Adjustable Accent, Polymer Trim Ring 6LA1= 6" Adjustable Accent, Self Flanged 6LLW0=6" Lensed Wall Wash, Polymer Trim Ring <sup>(9)</sup> 6LLW1=6" Lensed Wall Wash, Self Flanged <sup>(9)</sup> 6LAL0=6" Lensed Adjustable Accent, Polymer Trim Ring 6LAL1=6" Lensed Adjustable Accent, Self Flanged 6LFC0=6" Flat Cut, Polymer Trim Ring 6LFC1=6" Flat Cut, Self Flanged	LI=Specular Clear H=Semi-Specular Clear WMH=Warm Haze G=Specular Gold WH=Wheat WHH=Wheat Haze	GP=Graphite GPH=Graphite Haze B=Specular Black MW=Matte White	<b>Self-Flanged Only</b> WF=White Painted Flange

Accessories <sup>(15)</sup>				
TRM6P=Metal Trim Ring, White <sup>(2)</sup> TRM6MB=Metal Trim Ring, Black <sup>(2)</sup> TRR6=Rimless Trim Ring <sup>(2)</sup> LGSKT6IP66=IP66 Gasket Kit <sup>(4)</sup>  <b>Bar Hangers</b> HB26=C-channel Bar Hanger,26" Long, Pair TAA-HB26=Pair C-channel bar hanger, 26" long <sup>(14)</sup> HB50=C-channel Bar Hanger, 50" Long, Pair RMB22=Wood Joist Bar Hanger,22" Long, Pair	<b>Transformers</b> H347=347 to 120V Step Down Transformer, 75VA H347200=347 to 120V StepDown Transformer, 200VA  <b>Connected Lighting Systems <sup>(3)(11)</sup></b> WPST = Field installed WaveLinX sensor Kit <sup>(12)</sup> WLST = Field installed WaveLinX LITE Sensor Kit <sup>(13)</sup>	<b>Color Filters</b> F22-20=Red F33-20=Blue F44-20=Green F55-20=Yellow F66-20=Mercury	<b>Dichronic Filters</b> F71-20=Peach F72-20=Amber F73-20=Green F74-20=Medium Blue F75-20=Yellow F76-20=Red F77-20=Dark Blue F78-20=Light Blue F79-20=Neutral Density F80-20=Magenta	<b>Beam-Modifying Lenses</b> LSL-20=Linear Spread Lens OSL-20=Overall Spread Lens DIF-20=Diffused Lens  <b>Louvers</b> LVR-20=Hex Cell Louver

Notes:

- Nominal Lumens will vary depending on selected color, driver and reflector finish.
- Order trim with polymer trim ring (Consult specification sheet for color ordering information and options).
- Not available with Chicago Plenum and requires above ceiling access. Not for use with insulation.
- Required for T-24 compliance with lensed trims.
- Product is marked spacing and must be installed with the following minimum spacing:  
Center to center of adjacent luminaires: 36"  
Center of luminaire to side of building member: 18"  
Minimum overhead clearance: 1/2"
- Not CSA approved.
- Not available in Chicago Plenum.
- Includes 30° distribution diffuse lens. Order with LARL15SP upper reflector. Reference ies files for output.

- Use with narrow flood beam forming reflector and 30° tilt.
- DMX fixtures default to full on upon loss of DMX signal.
- Refer to system specifications for additional information, features, and benefits. Order either factory installed option or accessory. Use with 0-10V driver.
- WPST = WaveLinX wireless sensor kit for daylight dimming, PIR motion sensing, and optional RLTS - Real Time Location Services, use with 0-10V only.
- WLST = WaveLinX LITE tile mount sensor kit for daylight dimming, PIR motion sensing, use with D010 only (Refer to WaveLinX LITE system specifications)
- Only Product configurations with this designated prefix are built to be compliant with the Trade Agreements Act of 1979 (TAA). Please refer to [DOMESTIC PREFERENCES](#) website for more information. Components shipped separately may be separately analyzed under domestic preference requirements.
- Accessories sold separately will be separately analyzed under domestic preference requirements. Consult factory for further information.
- WPN = WaveLinX PRO wireless node Provides luminaire-level control with

scene and zone configuration without an integrated sensor; Connects wirelessly with daylight dimming sensor and PIR motion sensor if desired. Use with 0-10V driver only.  
17. WLN = WaveLinX LITE wireless node provides luminaire-level control with scene and zone configuration without an integrated sensor; Connects wirelessly with daylight dimming sensor and PIR motion sensor if desired. Use with 0-10V driver only.

## Product Specifications

### Lower Reflector

- Spun 0.050" aluminum.
- Available in a variety of Alzak® and painted finishes.
- Two torsion springs pull trim tight to ceiling.
- Reflector is keyed to prevent improper orientation relative to LED position.
- Truncated adjustable cut cone allows for full tilt range and flexibility.
- Lensed wall wash provides even illumination on vertical surfaces.

### Upper Reflector

- Field interchangeable optics provide smooth beam without color separation.
- Media holder fits onto upper reflector and holds up to two lens media.

### Trim Ring

- Self flanged or white polymer trim ring.

### Adjustment Mechanism

- Stable aiming and locking mechanism allows smooth 362° rotation and 45° elevation adjustment.
- Aiming scale enables consistent setting across multiple fixtures.

### Housing

- One piece die cast 1-5/8" deep collar.
- 18 gauge CRS housing is painted matte black to eliminate stray light.
- Housing is toolless top accessible.

### Universal Mounting Bracket

- Accepts 1/2" EMT, C-Channel, T bar fasteners and hanger bars.
- Provides 5" total adjustment.

### Thermal

- Aluminum heat sink conducts heat away from the LED module for optimal performance and long life.

### LED

- LED system contains a plurality of high brightness white LED's combined with a high reflectance upper reflector producing even distribution with no pixilation.
- Lumen output shall not decrease by more than 10% over the minimum life of 55,000 hours (L90 > 55,000 hours)
- Auto resetting, thermally protected, LED's are turned off when safe operating temperatures are exceeded.
- Color variation within 3-step MacAdam ellipses.
- D2W™ – dim-to-warm shifts CCT from 3000K to 1850K as fixture dims mimicking halogen sources.

### Driver

- Combination 120-277V 0-10V or 120V trailing edge phase cut driver provides flicker free dimming from 100% to 10%.
- Optional 1% 0-10V, Fifth Light, or DMX.
- Driver can be serviced from above or through the aperture.

### Connected Lighting System

Two WaveLinX connected solutions to choose from. Refer to WaveLinX system specifications and application guides for details.

#### WaveLinX PRO Tilemount Sensor Kit

- WaveLinX PRO WPST tilemount sensor kit offers daylight dimming, PIR motion sensing, scene and zone configuration, automatic commissioning; and optional RLTS - RealTime Location Services available.

#### WaveLinX PRO Wireless Node

- WaveLinX PRO WPN wireless node provides luminaire-level control with scene and zone configuration without an integrated sensor; Connects wirelessly with daylight dimming sensor and PIR motion sensor if desired. Use with 0-10V driver only. **Note:** Not compatible with 347V or Chicago plenum.

#### WaveLinX LITE Tilemount Sensor Kit

- WaveLinX LITE WLST tilemount sensor kit offers daylight dimming and PIR motion sensing, scene and grouping configuration.

#### WaveLinX LITE Wireless Node

- WaveLinX LITE WLN wireless node provides luminaire level control with scene and zone configuration without an integrated sensor; Connects wirelessly with daylight dimming sensor and PIR motion sensor if desired. Use with 0-10V driver only. **Note:** Not compatible with 347V or Chicago plenum.

### WaveLinX Tilemount Sensor Kits Application

- The WPST and WLST tilemount sensor kits include a control module mounted on the luminaire junction box via 1/2" knock-out, and a tilemount sensor on 54-inch whip; for ceiling installation by direct-mount spring clips or via mounting bracket in octagon ceiling boxes.
- The WPST and WLST tilemount sensor kits may be ordered as factory installed on the luminaire, or ordered separately as a field installed accessory kit.
- **Note: WaveLinX PRO devices are only compatible with the WaveLinX PRO system.**
- **Note: WaveLinX LITE devices are only compatible with the WaveLinX LITE system.**

### Code Compliance

- Thermally PROtected
- cULus Certified to UL 1598 / C22.2 No. 250.0 suitable for wet locations with downlight; damp location with wall wash and hyperbolic with covered ceiling
- Optional City of Chicago environmental air (CCEA) marking for plenum applications.
- EMI/RFI emissions per FCC 47CFR Part 18 Class B consumer limits.
- 3000 lumen Non-IC rated - Insulation must be kept 3" from top and sides of housing. IC rated up to 2000 lumen.
- RoHS Compliant.
- 3000 lumen and above are marked spacing and must follow spacing requirements.
- Photometric testing completed in accordance with IES LM 79 standards.
- Lumen maintenance projections in accordance with IES LM-80-08 and TM-21-11.
- Options to meet Trade Agreements Act requirements

### Warranty

- Five year warranty [www.cooperlighting.com/legal](http://www.cooperlighting.com/legal)

## Energy Data

ENERGY DATA	
Sound Rating: Class A standards	
T ambient -40 + 40°C	
Power Factor: >0.90	
THD < 20%	

1000 Lumen		
	120V	277V
Input Power	13.8W	15.0W
Input Current	0.12A	0.06A
Inrush Current	0.49A	0.85A

1500 Lumen		
	120V	277V
Input Power	22.9W	22.9W
Input Current	0.19A	0.09A
Inrush Current	0.72A	0.53A

2000 Lumen		
	120V	277V
Input Power	29.1W	29.4W
Input Current	0.24A	0.12A
Inrush Current	0.79A	1.09A

3000 Lumen		
	120V	277V
Input Power	44.5W	44.2W
Input Current	0.37A	0.17A
Inrush Current	1.09A	1.23A

4500 Lumen		
	120V	277V
Input Power	54.4W	52.2W
Input Current	0.46A	0.2A
Inrush Current	0.48A	1.316A

5500 Lumen		
	120V	277V
Input Power	60.8W	60.5W
Input Current	0.51A	0.24A
Inrush Current	1.248A	2.944A

6500 Lumen		
	120V	277V
Input Power	78.7W	77.5W
Input Current	0.66A	0.3A
Inrush Current	0.224A	0.704A

7500 Lumen		
	120V	277V
Input Power	78.7W	77.5W
Input Current	0.66A	0.3A
Inrush Current	0.224A	0.704A

## Photometric Data

 View IES files

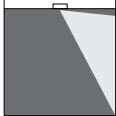
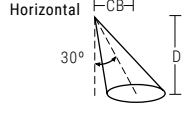
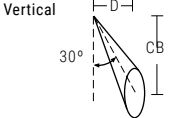
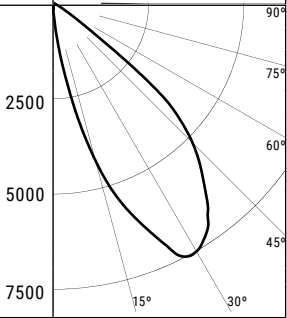
<b>Test</b> P175593 <b>Number</b> <b>Housing</b> LDA6A30835D-010TE <b>Trim</b> LAR35FL 6LAL1 30° Tilt <b>Lumens</b> 2489 Lm <b>Efficacy</b> 55.9Lm/W 	<b>CANDLEPOWER DISTRIBUTION</b> <b>Directional</b>		<b>CONE OF LIGHT</b> Horizontal 					<b>CONE OF LIGHT</b> Vertical 					<b>CANDELA TABLE</b>		<b>ZONAL LUMEN SUMMARY</b>																																																																																																								
		<table border="1"> <thead> <tr> <th>MH</th> <th>FC</th> <th>L</th> <th>W</th> <th>CB</th> </tr> </thead> <tbody> <tr><td>5.5'</td><td>52.3</td><td>5.7</td><td>4.8</td><td>3.2</td></tr> <tr><td>7'</td><td>32.3</td><td>7.3</td><td>6</td><td>4</td></tr> <tr><td>8'</td><td>24.7</td><td>8.4</td><td>7</td><td>4.6</td></tr> <tr><td>9'</td><td>19.5</td><td>9.4</td><td>7.8</td><td>5.2</td></tr> <tr><td>10'</td><td>15.8</td><td>10.5</td><td>8.6</td><td>5.8</td></tr> <tr><td>12'</td><td>11</td><td>12.5</td><td>10.4</td><td>6.9</td></tr> </tbody> </table>	MH	FC	L	W	CB	5.5'	52.3	5.7	4.8	3.2	7'	32.3	7.3	6	4	8'	24.7	8.4	7	4.6	9'	19.5	9.4	7.8	5.2	10'	15.8	10.5	8.6	5.8	12'	11	12.5	10.4	6.9	<table border="1"> <thead> <tr> <th>D</th> <th>FC</th> <th>L</th> <th>W</th> <th>CB</th> </tr> </thead> <tbody> <tr><td>1'</td><td>5254.9</td><td>0.6</td><td>0.6</td><td>1.7</td></tr> <tr><td>2'</td><td>1313.7</td><td>1.2</td><td>1.2</td><td>3.5</td></tr> <tr><td>3'</td><td>583.9</td><td>2</td><td>1.8</td><td>5.2</td></tr> <tr><td>4'</td><td>328.4</td><td>2.6</td><td>2.6</td><td>6.9</td></tr> <tr><td>5'</td><td>210.2</td><td>3.3</td><td>3.2</td><td>8.7</td></tr> <tr><td>6'</td><td>146</td><td>4</td><td>3.8</td><td>10.4</td></tr> </tbody> </table>	D	FC	L	W	CB	1'	5254.9	0.6	0.6	1.7	2'	1313.7	1.2	1.2	3.5	3'	583.9	2	1.8	5.2	4'	328.4	2.6	2.6	6.9	5'	210.2	3.3	3.2	8.7	6'	146	4	3.8	10.4	<table border="1"> <thead> <tr> <th>Degrees Vertical</th> <th>Candela</th> </tr> </thead> <tbody> <tr><td>0</td><td>182</td></tr> <tr><td>5</td><td>685</td></tr> <tr><td>15</td><td>4263</td></tr> <tr><td>25</td><td>6978</td></tr> <tr><td>35</td><td>7044</td></tr> <tr><td>45</td><td>5112</td></tr> <tr><td>55</td><td>751</td></tr> <tr><td>65</td><td>18</td></tr> <tr><td>75</td><td>0</td></tr> <tr><td>85</td><td>0</td></tr> <tr><td>90</td><td>0</td></tr> </tbody> </table>	Degrees Vertical	Candela	0	182	5	685	15	4263	25	6978	35	7044	45	5112	55	751	65	18	75	0	85	0	90	0	<table border="1"> <thead> <tr> <th>Zone</th> <th>Lumens</th> <th>% Fixture</th> </tr> </thead> <tbody> <tr><td>0-30</td><td>997</td><td>40.1</td></tr> <tr><td>0-40</td><td>1802</td><td>72.4</td></tr> <tr><td>0-60</td><td>2476</td><td>99.5</td></tr> <tr><td>0-90</td><td>2489</td><td>100</td></tr> <tr><td>90-180</td><td>0</td><td>0</td></tr> <tr><td>0-180</td><td>2489</td><td>100</td></tr> </tbody> </table>	Zone	Lumens	% Fixture	0-30	997	40.1	0-40	1802	72.4	0-60	2476	99.5	0-90	2489	100	90-180	0	0	0-180	2489
MH	FC	L	W	CB																																																																																																																			
5.5'	52.3	5.7	4.8	3.2																																																																																																																			
7'	32.3	7.3	6	4																																																																																																																			
8'	24.7	8.4	7	4.6																																																																																																																			
9'	19.5	9.4	7.8	5.2																																																																																																																			
10'	15.8	10.5	8.6	5.8																																																																																																																			
12'	11	12.5	10.4	6.9																																																																																																																			
D	FC	L	W	CB																																																																																																																			
1'	5254.9	0.6	0.6	1.7																																																																																																																			
2'	1313.7	1.2	1.2	3.5																																																																																																																			
3'	583.9	2	1.8	5.2																																																																																																																			
4'	328.4	2.6	2.6	6.9																																																																																																																			
5'	210.2	3.3	3.2	8.7																																																																																																																			
6'	146	4	3.8	10.4																																																																																																																			
Degrees Vertical	Candela																																																																																																																						
0	182																																																																																																																						
5	685																																																																																																																						
15	4263																																																																																																																						
25	6978																																																																																																																						
35	7044																																																																																																																						
45	5112																																																																																																																						
55	751																																																																																																																						
65	18																																																																																																																						
75	0																																																																																																																						
85	0																																																																																																																						
90	0																																																																																																																						
Zone	Lumens	% Fixture																																																																																																																					
0-30	997	40.1																																																																																																																					
0-40	1802	72.4																																																																																																																					
0-60	2476	99.5																																																																																																																					
0-90	2489	100																																																																																																																					
90-180	0	0																																																																																																																					
0-180	2489	100																																																																																																																					

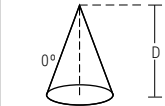
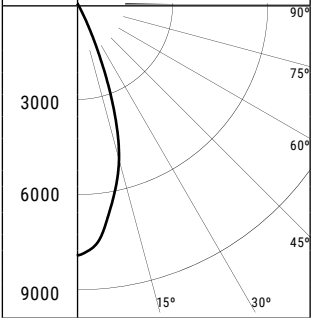
<b>Test</b> P175529 <b>Number</b> <b>Housing</b> LDA6A30835D010TE <b>Trim</b> LAR35FL 6LFC1 <b>Lumens</b> 2690 Lm <b>Efficacy</b> 60.5 Lm/W <b>SC</b> 0.6 	<b>CANDLEPOWER DISTRIBUTION</b> <b>Downlight</b>		<b>CONE OF LIGHT</b> 				<b>CANDELA TABLE</b>		<b>ZONAL LUMEN SUMMARY</b>																																																																			
		<table border="1"> <thead> <tr> <th>MH</th> <th>FC</th> <th>L</th> <th>W</th> </tr> </thead> <tbody> <tr><td>5.5'</td><td>261.3</td><td>3.2</td><td>3.2</td></tr> <tr><td>7'</td><td>161.3</td><td>4.2</td><td>4.2</td></tr> <tr><td>8'</td><td>123.5</td><td>4.8</td><td>4.8</td></tr> <tr><td>9'</td><td>97.6</td><td>5.4</td><td>5.4</td></tr> <tr><td>10'</td><td>79.1</td><td>6</td><td>6</td></tr> <tr><td>12'</td><td>54.9</td><td>7.2</td><td>7.2</td></tr> </tbody> </table>	MH	FC	L	W	5.5'	261.3	3.2	3.2	7'	161.3	4.2	4.2	8'	123.5	4.8	4.8	9'	97.6	5.4	5.4	10'	79.1	6	6	12'	54.9	7.2	7.2	<table border="1"> <thead> <tr> <th>Degrees Vertical</th> <th>Candela</th> </tr> </thead> <tbody> <tr><td>0</td><td>7905</td></tr> <tr><td>5</td><td>7515</td></tr> <tr><td>15</td><td>5097</td></tr> <tr><td>25</td><td>1179</td></tr> <tr><td>35</td><td>58</td></tr> <tr><td>45</td><td>5</td></tr> <tr><td>55</td><td>1</td></tr> <tr><td>65</td><td>0</td></tr> <tr><td>75</td><td>0</td></tr> <tr><td>85</td><td>0</td></tr> <tr><td>90</td><td>0</td></tr> </tbody> </table>	Degrees Vertical	Candela	0	7905	5	7515	15	5097	25	1179	35	58	45	5	55	1	65	0	75	0	85	0	90	0	<table border="1"> <thead> <tr> <th>Zone</th> <th>Lumens</th> <th>% Fixture</th> </tr> </thead> <tbody> <tr><td>0-30</td><td>2634</td><td>97.9</td></tr> <tr><td>0-40</td><td>2684</td><td>99.8</td></tr> <tr><td>0-60</td><td>2690</td><td>100</td></tr> <tr><td>0-90</td><td>2690</td><td>100</td></tr> <tr><td>90-180</td><td>0</td><td>0</td></tr> <tr><td>0-180</td><td>2690</td><td>100</td></tr> </tbody> </table>	Zone	Lumens	% Fixture	0-30	2634	97.9	0-40	2684	99.8	0-60	2690	100	0-90	2690	100	90-180	0	0	0-180	2690
MH	FC	L	W																																																																									
5.5'	261.3	3.2	3.2																																																																									
7'	161.3	4.2	4.2																																																																									
8'	123.5	4.8	4.8																																																																									
9'	97.6	5.4	5.4																																																																									
10'	79.1	6	6																																																																									
12'	54.9	7.2	7.2																																																																									
Degrees Vertical	Candela																																																																											
0	7905																																																																											
5	7515																																																																											
15	5097																																																																											
25	1179																																																																											
35	58																																																																											
45	5																																																																											
55	1																																																																											
65	0																																																																											
75	0																																																																											
85	0																																																																											
90	0																																																																											
Zone	Lumens	% Fixture																																																																										
0-30	2634	97.9																																																																										
0-40	2684	99.8																																																																										
0-60	2690	100																																																																										
0-90	2690	100																																																																										
90-180	0	0																																																																										
0-180	2690	100																																																																										

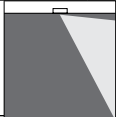
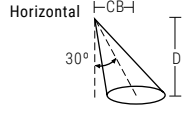
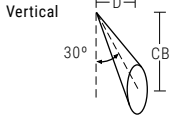
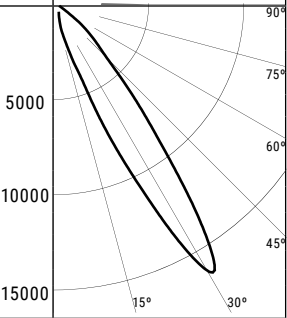
<b>Test</b> P175465 <b>Number</b> <b>Housing</b> LDA6A30835D-010TE <b>Trim</b> LAR15SP 6LAL1 30° Tilt <b>Lumens</b> 2222 Lm <b>Efficacy</b> 49.9 Lm/W 	<b>CANDLEPOWER DISTRIBUTION</b> <b>Directional</b>		<b>CONE OF LIGHT</b> Horizontal 					<b>CONE OF LIGHT</b> Vertical 					<b>CANDELA TABLE</b>		<b>ZONAL LUMEN SUMMARY</b>																																																																																																								
		<table border="1"> <thead> <tr> <th>MH</th> <th>FC</th> <th>L</th> <th>W</th> <th>CB</th> </tr> </thead> <tbody> <tr><td>5.5'</td><td>73.6</td><td>5.5</td><td>2.8</td><td>3.2</td></tr> <tr><td>7'</td><td>45.5</td><td>7</td><td>3.6</td><td>4</td></tr> <tr><td>8'</td><td>34.8</td><td>8</td><td>4</td><td>4.6</td></tr> <tr><td>9'</td><td>27.5</td><td>9</td><td>4.6</td><td>5.2</td></tr> <tr><td>10'</td><td>22.3</td><td>9.8</td><td>5.2</td><td>5.8</td></tr> <tr><td>12'</td><td>15.5</td><td>11.7</td><td>6.2</td><td>6.9</td></tr> </tbody> </table>	MH	FC	L	W	CB	5.5'	73.6	5.5	2.8	3.2	7'	45.5	7	3.6	4	8'	34.8	8	4	4.6	9'	27.5	9	4.6	5.2	10'	22.3	9.8	5.2	5.8	12'	15.5	11.7	6.2	6.9	<table border="1"> <thead> <tr> <th>D</th> <th>FC</th> <th>L</th> <th>W</th> <th>CB</th> </tr> </thead> <tbody> <tr><td>1'</td><td>10547.9</td><td>0.3</td><td>0.2</td><td>1.7</td></tr> <tr><td>2'</td><td>2637</td><td>0.6</td><td>0.4</td><td>3.5</td></tr> <tr><td>3'</td><td>1172</td><td>0.9</td><td>0.8</td><td>5.2</td></tr> <tr><td>4'</td><td>659.2</td><td>1.3</td><td>1</td><td>6.9</td></tr> <tr><td>5'</td><td>421.9</td><td>1.6</td><td>1.4</td><td>8.7</td></tr> <tr><td>6'</td><td>293</td><td>1.9</td><td>1.6</td><td>10.4</td></tr> </tbody> </table>	D	FC	L	W	CB	1'	10547.9	0.3	0.2	1.7	2'	2637	0.6	0.4	3.5	3'	1172	0.9	0.8	5.2	4'	659.2	1.3	1	6.9	5'	421.9	1.6	1.4	8.7	6'	293	1.9	1.6	10.4	<table border="1"> <thead> <tr> <th>Degrees Vertical</th> <th>Candela</th> </tr> </thead> <tbody> <tr><td>0</td><td>327</td></tr> <tr><td>5</td><td>1114</td></tr> <tr><td>15</td><td>3141</td></tr> <tr><td>25</td><td>11302</td></tr> <tr><td>35</td><td>10960</td></tr> <tr><td>45</td><td>2853</td></tr> <tr><td>55</td><td>43</td></tr> <tr><td>65</td><td>5</td></tr> <tr><td>75</td><td>1</td></tr> <tr><td>85</td><td>0</td></tr> <tr><td>90</td><td>0</td></tr> </tbody> </table>	Degrees Vertical	Candela	0	327	5	1114	15	3141	25	11302	35	10960	45	2853	55	43	65	5	75	1	85	0	90	0	<table border="1"> <thead> <tr> <th>Zone</th> <th>Lumens</th> <th>% Fixture</th> </tr> </thead> <tbody> <tr><td>0-30</td><td>1049</td><td>47.2</td></tr> <tr><td>0-40</td><td>1846</td><td>83.1</td></tr> <tr><td>0-60</td><td>2214</td><td>99.7</td></tr> <tr><td>0-90</td><td>2222</td><td>100</td></tr> <tr><td>90-180</td><td>0</td><td>0</td></tr> <tr><td>0-180</td><td>2222</td><td>100</td></tr> </tbody> </table>	Zone	Lumens	% Fixture	0-30	1049	47.2	0-40	1846	83.1	0-60	2214	99.7	0-90	2222	100	90-180	0	0	0-180	2222
MH	FC	L	W	CB																																																																																																																			
5.5'	73.6	5.5	2.8	3.2																																																																																																																			
7'	45.5	7	3.6	4																																																																																																																			
8'	34.8	8	4	4.6																																																																																																																			
9'	27.5	9	4.6	5.2																																																																																																																			
10'	22.3	9.8	5.2	5.8																																																																																																																			
12'	15.5	11.7	6.2	6.9																																																																																																																			
D	FC	L	W	CB																																																																																																																			
1'	10547.9	0.3	0.2	1.7																																																																																																																			
2'	2637	0.6	0.4	3.5																																																																																																																			
3'	1172	0.9	0.8	5.2																																																																																																																			
4'	659.2	1.3	1	6.9																																																																																																																			
5'	421.9	1.6	1.4	8.7																																																																																																																			
6'	293	1.9	1.6	10.4																																																																																																																			
Degrees Vertical	Candela																																																																																																																						
0	327																																																																																																																						
5	1114																																																																																																																						
15	3141																																																																																																																						
25	11302																																																																																																																						
35	10960																																																																																																																						
45	2853																																																																																																																						
55	43																																																																																																																						
65	5																																																																																																																						
75	1																																																																																																																						
85	0																																																																																																																						
90	0																																																																																																																						
Zone	Lumens	% Fixture																																																																																																																					
0-30	1049	47.2																																																																																																																					
0-40	1846	83.1																																																																																																																					
0-60	2214	99.7																																																																																																																					
0-90	2222	100																																																																																																																					
90-180	0	0																																																																																																																					
0-180	2222	100																																																																																																																					

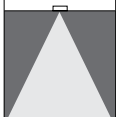
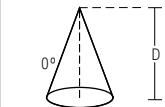
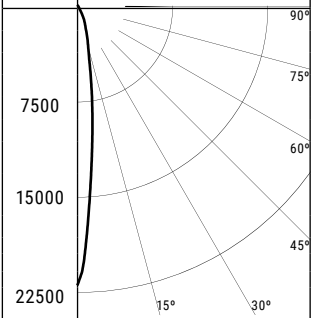
<b>Test</b> P175401 <b>Number</b> <b>Housing</b> LDA6A30835D010TE <b>Trim</b> LAR15SP 6LFC1 <b>Lumens</b> 2362 Lm <b>Efficacy</b> 53.1 Lm/W <b>SC</b> 0.26 	<b>CANDLEPOWER DISTRIBUTION</b> <b>Downlight</b>		<b>CONE OF LIGHT</b> 				<b>CANDELA TABLE</b>		<b>ZONAL LUMEN SUMMARY</b>																																																																			
		<table border="1"> <thead> <tr> <th>MH</th> <th>FC</th> <th>L</th> <th>W</th> </tr> </thead> <tbody> <tr><td>5.5'</td><td>261.3</td><td>3.2</td><td>3.2</td></tr> <tr><td>7'</td><td>161.3</td><td>4.2</td><td>4.2</td></tr> <tr><td>8'</td><td>123.5</td><td>4.8</td><td>4.8</td></tr> <tr><td>9'</td><td>97.6</td><td>5.4</td><td>5.4</td></tr> <tr><td>10'</td><td>79.1</td><td>6</td><td>6</td></tr> <tr><td>12'</td><td>54.9</td><td>7.2</td><td>7.2</td></tr> </tbody> </table>	MH	FC	L	W	5.5'	261.3	3.2	3.2	7'	161.3	4.2	4.2	8'	123.5	4.8	4.8	9'	97.6	5.4	5.4	10'	79.1	6	6	12'	54.9	7.2	7.2	<table border="1"> <thead> <tr> <th>Degrees Vertical</th> <th>Candela</th> </tr> </thead> <tbody> <tr><td>0</td><td>7905</td></tr> <tr><td>5</td><td>7515</td></tr> <tr><td>15</td><td>5097</td></tr> <tr><td>25</td><td>1179</td></tr> <tr><td>35</td><td>58</td></tr> <tr><td>45</td><td>5</td></tr> <tr><td>55</td><td>1</td></tr> <tr><td>65</td><td>0</td></tr> <tr><td>75</td><td>0</td></tr> <tr><td>85</td><td>0</td></tr> <tr><td>90</td><td>0</td></tr> </tbody> </table>	Degrees Vertical	Candela	0	7905	5	7515	15	5097	25	1179	35	58	45	5	55	1	65	0	75	0	85	0	90	0	<table border="1"> <thead> <tr> <th>Zone</th> <th>Lumens</th> <th>% Fixture</th> </tr> </thead> <tbody> <tr><td>0-30</td><td>2634</td><td>97.9</td></tr> <tr><td>0-40</td><td>2684</td><td>99.8</td></tr> <tr><td>0-60</td><td>2690</td><td>100</td></tr> <tr><td>0-90</td><td>2690</td><td>100</td></tr> <tr><td>90-180</td><td>0</td><td>0</td></tr> <tr><td>0-180</td><td>2690</td><td>100</td></tr> </tbody> </table>	Zone	Lumens	% Fixture	0-30	2634	97.9	0-40	2684	99.8	0-60	2690	100	0-90	2690	100	90-180	0	0	0-180	2690
MH	FC	L	W																																																																									
5.5'	261.3	3.2	3.2																																																																									
7'	161.3	4.2	4.2																																																																									
8'	123.5	4.8	4.8																																																																									
9'	97.6	5.4	5.4																																																																									
10'	79.1	6	6																																																																									
12'	54.9	7.2	7.2																																																																									
Degrees Vertical	Candela																																																																											
0	7905																																																																											
5	7515																																																																											
15	5097																																																																											
25	1179																																																																											
35	58																																																																											
45	5																																																																											
55	1																																																																											
65	0																																																																											
75	0																																																																											
85	0																																																																											
90	0																																																																											
Zone	Lumens	% Fixture																																																																										
0-30	2634	97.9																																																																										
0-40	2684	99.8																																																																										
0-60	2690	100																																																																										
0-90	2690	100																																																																										
90-180	0	0																																																																										
0-180	2690	100																																																																										

## Photometric Data

View IES files

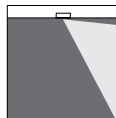
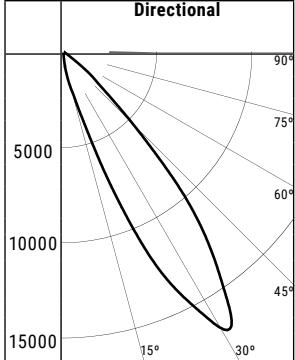
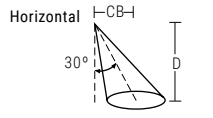
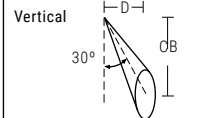
<b>Test</b> P175497 <b>Number</b> <b>Housing</b> LDA6A30835D-010TE <b>Trim</b> ARL20NF 6LAL1 30° Tilt <b>Lumens</b> 2566 Lm <b>Efficacy</b> 57.7 Lm/W 	<b>CANDLEPOWER DISTRIBUTION</b> <b>Directional</b> 	<b>CONE OF LIGHT</b> <b>Horizontal</b>  <table border="1"> <thead> <tr> <th>MH</th> <th>FC</th> <th>L</th> <th>W</th> <th>CB</th> </tr> </thead> <tbody> <tr><td>5.5'</td><td>84</td><td>5.5</td><td>3.4</td><td>3.2</td></tr> <tr><td>7'</td><td>51.9</td><td>7</td><td>4.4</td><td>4</td></tr> <tr><td>8'</td><td>39.7</td><td>7.9</td><td>5</td><td>4.6</td></tr> <tr><td>9'</td><td>31.4</td><td>8.9</td><td>5.6</td><td>5.2</td></tr> <tr><td>10'</td><td>25.4</td><td>9.8</td><td>6.2</td><td>5.8</td></tr> <tr><td>12'</td><td>17.6</td><td>11.7</td><td>7.6</td><td>6.9</td></tr> </tbody> </table>	MH	FC	L	W	CB	5.5'	84	5.5	3.4	3.2	7'	51.9	7	4.4	4	8'	39.7	7.9	5	4.6	9'	31.4	8.9	5.6	5.2	10'	25.4	9.8	6.2	5.8	12'	17.6	11.7	7.6	6.9	<b>CONE OF LIGHT</b> <b>Vertical</b>  <table border="1"> <thead> <tr> <th>D</th> <th>FC</th> <th>L</th> <th>W</th> <th>CB</th> </tr> </thead> <tbody> <tr><td>1'</td><td>11381.5</td><td>0.3</td><td>0.2</td><td>1.7</td></tr> <tr><td>2'</td><td>2845.4</td><td>0.8</td><td>0.6</td><td>3.5</td></tr> <tr><td>3'</td><td>1264.6</td><td>1.2</td><td>1</td><td>5.2</td></tr> <tr><td>4'</td><td>711.3</td><td>1.7</td><td>1.4</td><td>6.9</td></tr> <tr><td>5'</td><td>455.3</td><td>2.2</td><td>1.8</td><td>8.7</td></tr> <tr><td>6'</td><td>316.2</td><td>2.6</td><td>2.2</td><td>10.4</td></tr> </tbody> </table>	D	FC	L	W	CB	1'	11381.5	0.3	0.2	1.7	2'	2845.4	0.8	0.6	3.5	3'	1264.6	1.2	1	5.2	4'	711.3	1.7	1.4	6.9	5'	455.3	2.2	1.8	8.7	6'	316.2	2.6	2.2	10.4	<b>CANDELA TABLE</b> <table border="1"> <thead> <tr> <th>Degrees Vertical</th> <th>Candela</th> </tr> </thead> <tbody> <tr><td>0</td><td>58</td></tr> <tr><td>5</td><td>561</td></tr> <tr><td>15</td><td>3193</td></tr> <tr><td>25</td><td>13468</td></tr> <tr><td>35</td><td>14168</td></tr> <tr><td>45</td><td>4072</td></tr> <tr><td>55</td><td>133</td></tr> <tr><td>65</td><td>5</td></tr> <tr><td>75</td><td>0</td></tr> <tr><td>85</td><td>0</td></tr> <tr><td>90</td><td>0</td></tr> </tbody> </table>	Degrees Vertical	Candela	0	58	5	561	15	3193	25	13468	35	14168	45	4072	55	133	65	5	75	0	85	0	90	0	<b>ZONAL LUMEN SUMMARY</b> <table border="1"> <thead> <tr> <th>Zone</th> <th>Lumens</th> <th>% Fixture</th> </tr> </thead> <tbody> <tr><td>0-30</td><td>1092</td><td>42.6</td></tr> <tr><td>0-40</td><td>2122</td><td>82.7</td></tr> <tr><td>0-60</td><td>2557</td><td>99.6</td></tr> <tr><td>0-90</td><td>2566</td><td>100</td></tr> <tr><td>90-180</td><td>0</td><td>0</td></tr> <tr><td>0-180</td><td>2566</td><td>100</td></tr> </tbody> </table>	Zone	Lumens	% Fixture	0-30	1092	42.6	0-40	2122	82.7	0-60	2557	99.6	0-90	2566	100	90-180	0	0	0-180	2566	100
	MH	FC	L	W	CB																																																																																																																			
5.5'	84	5.5	3.4	3.2																																																																																																																				
7'	51.9	7	4.4	4																																																																																																																				
8'	39.7	7.9	5	4.6																																																																																																																				
9'	31.4	8.9	5.6	5.2																																																																																																																				
10'	25.4	9.8	6.2	5.8																																																																																																																				
12'	17.6	11.7	7.6	6.9																																																																																																																				
D	FC	L	W	CB																																																																																																																				
1'	11381.5	0.3	0.2	1.7																																																																																																																				
2'	2845.4	0.8	0.6	3.5																																																																																																																				
3'	1264.6	1.2	1	5.2																																																																																																																				
4'	711.3	1.7	1.4	6.9																																																																																																																				
5'	455.3	2.2	1.8	8.7																																																																																																																				
6'	316.2	2.6	2.2	10.4																																																																																																																				
Degrees Vertical	Candela																																																																																																																							
0	58																																																																																																																							
5	561																																																																																																																							
15	3193																																																																																																																							
25	13468																																																																																																																							
35	14168																																																																																																																							
45	4072																																																																																																																							
55	133																																																																																																																							
65	5																																																																																																																							
75	0																																																																																																																							
85	0																																																																																																																							
90	0																																																																																																																							
Zone	Lumens	% Fixture																																																																																																																						
0-30	1092	42.6																																																																																																																						
0-40	2122	82.7																																																																																																																						
0-60	2557	99.6																																																																																																																						
0-90	2566	100																																																																																																																						
90-180	0	0																																																																																																																						
0-180	2566	100																																																																																																																						

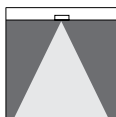
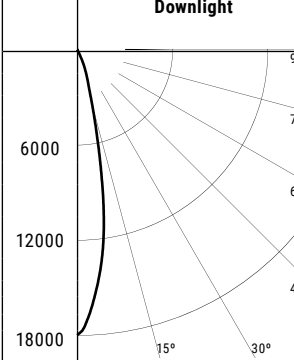
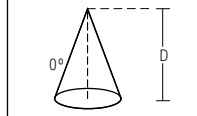
<b>Test</b> P175433 <b>Number</b> <b>Housing</b> LDA6A30835D010TE <b>Trim</b> LARL20NF 6LFC1 <b>Lumens</b> 2695 Lm <b>Efficacy</b> 60.6 Lm/W <b>SC</b> 0.34 	<b>CANDLEPOWER DISTRIBUTION</b> <b>Downlight</b> 	<b>CONE OF LIGHT</b>  <table border="1"> <thead> <tr> <th>MH</th> <th>FC</th> <th>L</th> <th>W</th> </tr> </thead> <tbody> <tr><td>5.5'</td><td>589.9</td><td>1.8</td><td>1.8</td></tr> <tr><td>7'</td><td>364.2</td><td>2.4</td><td>2.4</td></tr> <tr><td>8'</td><td>278.8</td><td>2.8</td><td>2.8</td></tr> <tr><td>9'</td><td>220.3</td><td>3</td><td>3</td></tr> <tr><td>10'</td><td>178.5</td><td>3.4</td><td>3.4</td></tr> <tr><td>12'</td><td>123.9</td><td>4.2</td><td>4.2</td></tr> </tbody> </table>	MH	FC	L	W	5.5'	589.9	1.8	1.8	7'	364.2	2.4	2.4	8'	278.8	2.8	2.8	9'	220.3	3	3	10'	178.5	3.4	3.4	12'	123.9	4.2	4.2	<b>CANDELA TABLE</b> <table border="1"> <thead> <tr> <th>Degrees Vertical</th> <th>Candela</th> </tr> </thead> <tbody> <tr><td>0</td><td>17845</td></tr> <tr><td>5</td><td>14698</td></tr> <tr><td>15</td><td>3736</td></tr> <tr><td>25</td><td>627</td></tr> <tr><td>35</td><td>8</td></tr> <tr><td>45</td><td>1</td></tr> <tr><td>55</td><td>0</td></tr> <tr><td>65</td><td>0</td></tr> <tr><td>75</td><td>0</td></tr> <tr><td>85</td><td>0</td></tr> <tr><td>90</td><td>0</td></tr> </tbody> </table>	Degrees Vertical	Candela	0	17845	5	14698	15	3736	25	627	35	8	45	1	55	0	65	0	75	0	85	0	90	0	<b>ZONAL LUMEN SUMMARY</b> <table border="1"> <thead> <tr> <th>Zone</th> <th>Lumens</th> <th>% Fixture</th> </tr> </thead> <tbody> <tr><td>0-30</td><td>2686</td><td>99.7</td></tr> <tr><td>0-40</td><td>2694</td><td>100</td></tr> <tr><td>0-60</td><td>2695</td><td>100</td></tr> <tr><td>0-90</td><td>2695</td><td>100</td></tr> <tr><td>90-180</td><td>0</td><td>0</td></tr> <tr><td>0-180</td><td>2695</td><td>100</td></tr> </tbody> </table>	Zone	Lumens	% Fixture	0-30	2686	99.7	0-40	2694	100	0-60	2695	100	0-90	2695	100	90-180	0	0	0-180	2695	100
	MH	FC	L	W																																																																									
5.5'	589.9	1.8	1.8																																																																										
7'	364.2	2.4	2.4																																																																										
8'	278.8	2.8	2.8																																																																										
9'	220.3	3	3																																																																										
10'	178.5	3.4	3.4																																																																										
12'	123.9	4.2	4.2																																																																										
Degrees Vertical	Candela																																																																												
0	17845																																																																												
5	14698																																																																												
15	3736																																																																												
25	627																																																																												
35	8																																																																												
45	1																																																																												
55	0																																																																												
65	0																																																																												
75	0																																																																												
85	0																																																																												
90	0																																																																												
Zone	Lumens	% Fixture																																																																											
0-30	2686	99.7																																																																											
0-40	2694	100																																																																											
0-60	2695	100																																																																											
0-90	2695	100																																																																											
90-180	0	0																																																																											
0-180	2695	100																																																																											

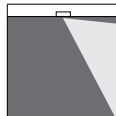
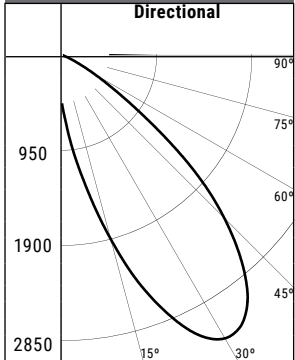
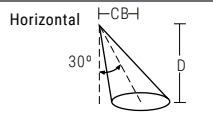
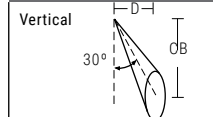
<b>Test</b> P175561 <b>Number</b> <b>Housing</b> LDA6A30835D-010TE <b>Trim</b> LAR35FL 6LLWW1 <b>Lumens</b> 2015 Lm <b>Efficacy</b> 45.3 Lm/W 	<b>CANDLEPOWER DISTRIBUTION</b> <b>Directional</b> 	<b>CONE OF LIGHT</b> <b>Horizontal</b>  <table border="1"> <thead> <tr> <th>MH</th> <th>FC</th> <th>L</th> <th>W</th> <th>CB</th> </tr> </thead> <tbody> <tr><td>5.5'</td><td>22.8</td><td>6.8</td><td>6</td><td>3.2</td></tr> <tr><td>7'</td><td>14.1</td><td>8.7</td><td>7.6</td><td>4</td></tr> <tr><td>8'</td><td>10.8</td><td>9.9</td><td>8.8</td><td>4.6</td></tr> <tr><td>9'</td><td>8.5</td><td>11.2</td><td>10</td><td>5.2</td></tr> <tr><td>10'</td><td>6.9</td><td>12.3</td><td>11</td><td>5.8</td></tr> <tr><td>12'</td><td>4.8</td><td>14.7</td><td>13.2</td><td>6.9</td></tr> </tbody> </table>	MH	FC	L	W	CB	5.5'	22.8	6.8	6	3.2	7'	14.1	8.7	7.6	4	8'	10.8	9.9	8.8	4.6	9'	8.5	11.2	10	5.2	10'	6.9	12.3	11	5.8	12'	4.8	14.7	13.2	6.9	<b>CONE OF LIGHT</b> <b>Vertical</b>  <table border="1"> <thead> <tr> <th>D</th> <th>FC</th> <th>L</th> <th>W</th> <th>CB</th> </tr> </thead> <tbody> <tr><td>1'</td><td>2380.4</td><td>0.6</td><td>0.6</td><td>1.7</td></tr> <tr><td>2'</td><td>595.1</td><td>1.3</td><td>1.4</td><td>3.5</td></tr> <tr><td>3'</td><td>264.5</td><td>1.9</td><td>2.2</td><td>5.2</td></tr> <tr><td>4'</td><td>148.8</td><td>2.6</td><td>3</td><td>6.9</td></tr> <tr><td>5'</td><td>95.2</td><td>3.4</td><td>3.8</td><td>8.7</td></tr> <tr><td>6'</td><td>66.1</td><td>4</td><td>4.6</td><td>10.4</td></tr> </tbody> </table>	D	FC	L	W	CB	1'	2380.4	0.6	0.6	1.7	2'	595.1	1.3	1.4	3.5	3'	264.5	1.9	2.2	5.2	4'	148.8	2.6	3	6.9	5'	95.2	3.4	3.8	8.7	6'	66.1	4	4.6	10.4	<b>CANDELA TABLE</b> <table border="1"> <thead> <tr> <th>Degrees Vertical</th> <th>Candela</th> </tr> </thead> <tbody> <tr><td>0</td><td>427</td></tr> <tr><td>5</td><td>726</td></tr> <tr><td>15</td><td>1654</td></tr> <tr><td>25</td><td>2420</td></tr> <tr><td>35</td><td>2384</td></tr> <tr><td>45</td><td>1609</td></tr> <tr><td>55</td><td>551</td></tr> <tr><td>65</td><td>108</td></tr> <tr><td>75</td><td>8</td></tr> <tr><td>85</td><td>3</td></tr> <tr><td>90</td><td>0</td></tr> </tbody> </table>	Degrees Vertical	Candela	0	427	5	726	15	1654	25	2420	35	2384	45	1609	55	551	65	108	75	8	85	3	90	0	<b>ZONAL LUMEN SUMMARY</b> <table border="1"> <thead> <tr> <th>Zone</th> <th>Lumens</th> <th>% Fixture</th> </tr> </thead> <tbody> <tr><td>0-30</td><td>694</td><td>34.5</td></tr> <tr><td>0-40</td><td>1263</td><td>62.7</td></tr> <tr><td>0-60</td><td>1959</td><td>97.2</td></tr> <tr><td>0-90</td><td>2015</td><td>100</td></tr> <tr><td>90-180</td><td>0</td><td>0</td></tr> <tr><td>0-180</td><td>2015</td><td>100</td></tr> </tbody> </table>	Zone	Lumens	% Fixture	0-30	694	34.5	0-40	1263	62.7	0-60	1959	97.2	0-90	2015	100	90-180	0	0	0-180	2015	100
	MH	FC	L	W	CB																																																																																																																			
5.5'	22.8	6.8	6	3.2																																																																																																																				
7'	14.1	8.7	7.6	4																																																																																																																				
8'	10.8	9.9	8.8	4.6																																																																																																																				
9'	8.5	11.2	10	5.2																																																																																																																				
10'	6.9	12.3	11	5.8																																																																																																																				
12'	4.8	14.7	13.2	6.9																																																																																																																				
D	FC	L	W	CB																																																																																																																				
1'	2380.4	0.6	0.6	1.7																																																																																																																				
2'	595.1	1.3	1.4	3.5																																																																																																																				
3'	264.5	1.9	2.2	5.2																																																																																																																				
4'	148.8	2.6	3	6.9																																																																																																																				
5'	95.2	3.4	3.8	8.7																																																																																																																				
6'	66.1	4	4.6	10.4																																																																																																																				
Degrees Vertical	Candela																																																																																																																							
0	427																																																																																																																							
5	726																																																																																																																							
15	1654																																																																																																																							
25	2420																																																																																																																							
35	2384																																																																																																																							
45	1609																																																																																																																							
55	551																																																																																																																							
65	108																																																																																																																							
75	8																																																																																																																							
85	3																																																																																																																							
90	0																																																																																																																							
Zone	Lumens	% Fixture																																																																																																																						
0-30	694	34.5																																																																																																																						
0-40	1263	62.7																																																																																																																						
0-60	1959	97.2																																																																																																																						
0-90	2015	100																																																																																																																						
90-180	0	0																																																																																																																						
0-180	2015	100																																																																																																																						

SINGLE UNIT FOOTCANDLES								MULTIPLE UNIT FOOTCANDLES		
DD	2' FROM WALL (Distance From Fixture Along Wall)							3' FROM WALL (Spacing Between Fixtures)		
	●	1'	2'	3'	4'	5'	6'	●	3' apart	●
1'	33.4	12.6	1.3	0.2	0.1	0	0	2.5	1.7	2.5
2'	200.1	103.4	20.5	2.8	0.5	0.1	0	45.1	36.4	45.1
3'	136.7	89.5	31.4	8.4	1.9	0.5	0.2	98	91.9	98
4'	69.6	52.5	25	9.8	3.5	1.1	0.4	87.1	90.1	87.1
5'	34.8	28.6	16.9	8.4	3.9	1.7	0.7	62.4	67.8	62.4
6'	18.5	16.1	10.8	6.4	3.5	1.8	0.9	42.1	46.7	42.1
7'	10.5	9.5	7	4.7	2.9	1.7	1	28	31.2	28
8'	6.3	5.9	4.6	3.3	2.3	1.5	0.9	19	20.9	19
9'	4	3.8	3.1	2.4	1.8	1.2	0.8	13.1	14.3	13.1
10'	2.7	2.6	2.2	1.8	1.4	1	0.7	9.2	10	9.2

## Connected Systems

### WaveLinx LITE - WLST Tilemount Sensor

**WaveLinx LITE devices only compatible with the WaveLinx LITE system.**

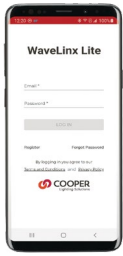

- Intuitive Android™ or Apple® iOS® app for basic system code compliant set up and configuration via Bluetooth
- Up to 28 unique areas per project site (WaveLinx LITE Bluetooth network)
- Up to 50 devices for an area, any one of 16 control zones, up to 6 occupancy sets, and custom lighting scenes
- Automatic occupancy or vacancy, sensor sensitivity, daylight dimming, etc. configurable through the app
- Refer to the WaveLinx system specifications for details



#### WaveLinx LITE WLST Tilemount Wiring Diagram

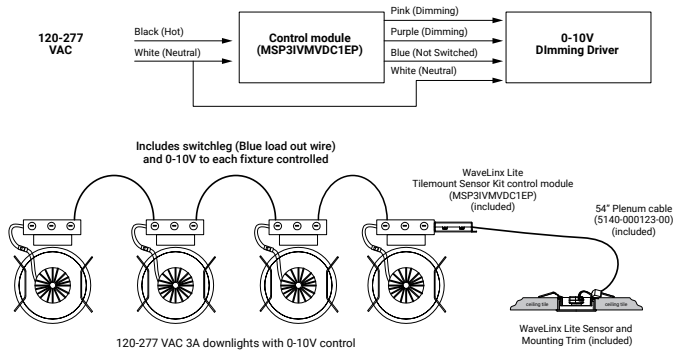

#### WaveLinx LITE Bluetooth Enabled System



### WaveLinx PRO Wireless – WPST Tilemount Sensor

**WaveLinx PRO devices only compatible with the WaveLinx PRO system.**



- WaveLinx PRO Wireless functionality configures zones and customizes settings from one secure mobile app
- Automatic code commissioning that meets the strictest codes
- Fixtures and sensors integrate with Wireless Area Controller, Wall Stations, and Control Devices
- Stand-Alone Offices or Entire Building Network Installations



#### WaveLinx mobile app settings

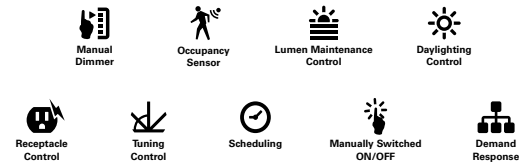

#### WaveLinx PRO WPST Tilemount Wiring Diagram

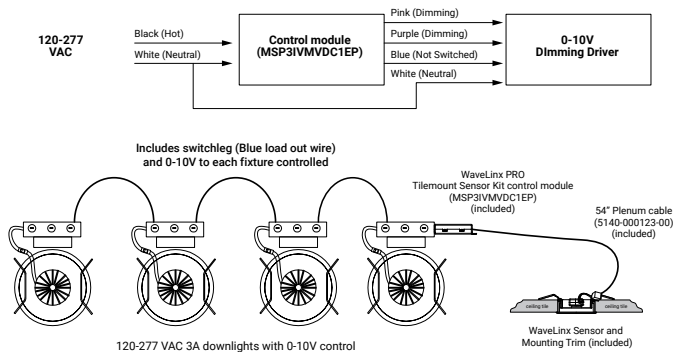

#### WaveLinx CORE Building Management Integration

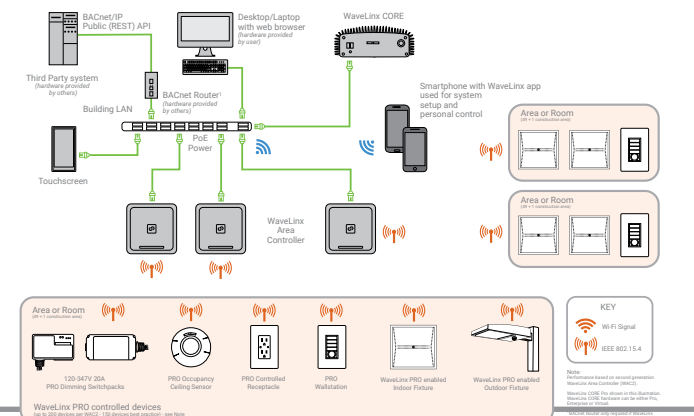

## Connected Solutions



### WaveLinX LITE Wireless Node - WLN

**WaveLinX LITE devices only compatible with the WaveLinX LITE system.**

- Intuitive Android™ or Apple® iOS® app for basic system code compliant set up and configuration via Bluetooth
- Up to 28 unique areas per project site (WaveLinX LITE Bluetooth network)
- Up to 50 devices for an area, any one of 16 control zones, up to 6 occupancy sets, and custom lighting scenes
- Refer to the WaveLinX system specifications for details
- **Not available with BioUp or Tunable White**

#### WaveLinX mobile app settings



#### WaveLinX LITE Wireless Node (WLN) Wiring Diagram

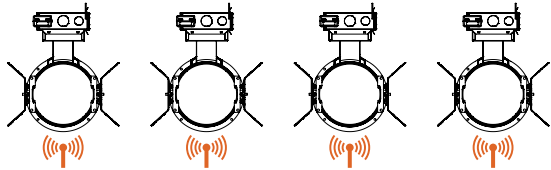
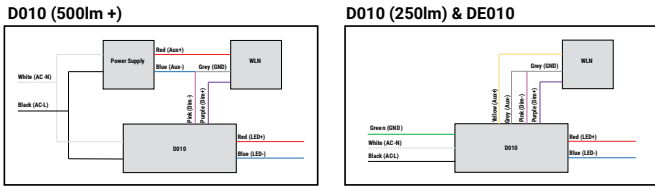

120-277 VAC 3A downlights with 0-10V control

#### WaveLinX LITE Bluetooth Enabled System



### WaveLinX PRO Wireless Node - WPN

**WaveLinX PRO devices only compatible with the WaveLinX PRO system.**

- WaveLinX Wireless functionality configures zones and customizes settings from one secure mobile app
- Automatic code commissioning that meets the strictest codes
- Fixtures and sensors integrate with WaveLinX Area Controller, Wall Stations, and Control Devices
- Stand-Alone Offices or Entire Building Network Installations

**Downlights with wireless communication**  
Highly efficient LED fixtures

**WaveLinX Area Controller**  
Provides centralized coordination of multiple area control options

**Wireless Wall Station/Receptacle**  
Provides customized wireless control of each area

**Mobile Applications**  
Provides personalized, local control from a tablet or smartphone

#### WaveLinX mobile app settings

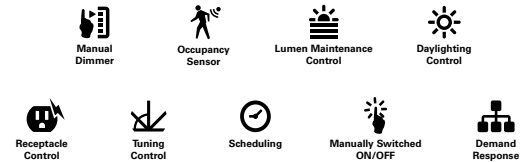

#### WaveLinX PRO Wireless Node (WPN) Wiring Diagram

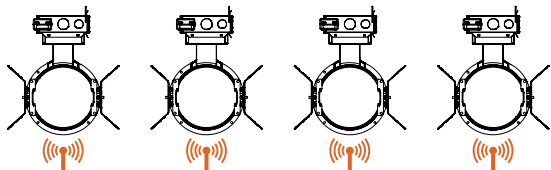
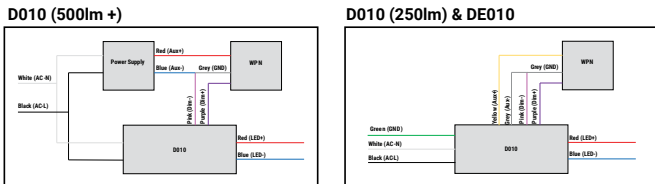

120-277 VAC 3A downlights with 0-10V control

#### WaveLinX CORE Building Management Integration

