

Project		Catalog #		Type	
Prepared by		Notes		Date	



Metalux

24RLN

2' x 4' Recessed LED
Specification Grade
Rectilinear Shielding

Typical Applications

- Commercial Office Spaces • Schools • Hospitals
- Retail Merchandising Areas

Interactive Menu

- Order Information [page 2](#)
- Photometric Data [page 4](#)
- Control Solutions [page 5](#)
- VividTune™ Color Tuning Solutions [page 6](#)
- Product Warranty

Product Certification



Product Features



Top Product Features

- Luminous center panel with gently elevated luminous side panels for a visually pleasing appearance
- Efficacy up to 139 lm/W, uniform illumination for a pleasant ambient environment
- 3000K, 3500K, and 4000K at 80 or 90 CRI
- White tuning solutions available, either 3000K - 5000K or 2700K - 6500K
- LED driver access from below the ceiling
- Options to meet Buy American and other domestic preference requirements

Dimensional and Mounting Details

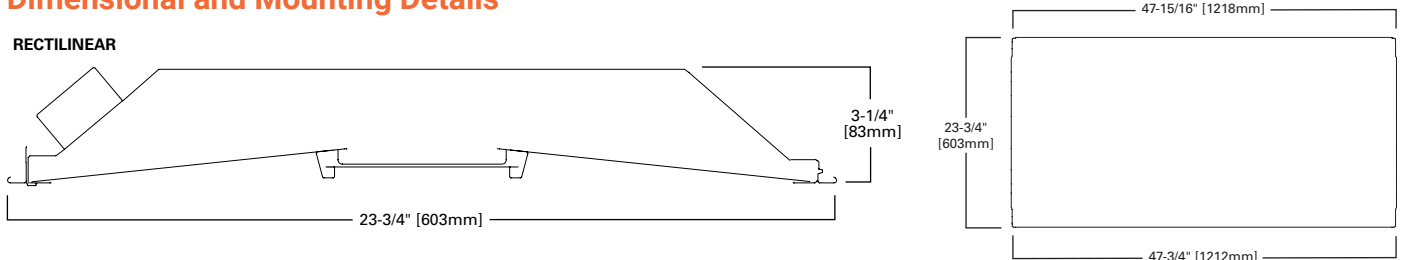

Ceiling Compatibility

G Grid/Lay-in Standard	G Concealed T	G Slot Grid	Ceiling Type	Trim Type
			Exposed Grid	G
			Concealed T	G
			Slot Grid	G
(Verify compatibility/ consult factory.)				

Order Information

SAMPLE ORDER NUMBER: **24RLN-LD5-45-UNV-L835-CD1-U**

Domestic Preferences	Rating	Series	Door Frame	Lamp Type	Lumen Output	Shielding	Voltage	Emergency	CCT
[Blank] =Standard BAA =Buy American Act TAA =Trade Agreements Act	[Blank] =Standard ATW-SW4 =Chicago Rated	24RLN=2x4 RLN Series	Standard =Flat White Steel Door (Leave Blank)	LD5=LED 5.0	Stock 45=4500 Lumen 55=5500 Lumen MTO 31=3100 Lumen 36=3600 Lumen 42=4200 Lumen 50=5000 Lumen 60=6000 Lumen 67=6700 Lumen 74=7400 Lumen 80=8000 Lumen	[Blank] =Standard Lens RDP =Rectilinear with Round Pattern Insert	347V =347 Volt ⁽⁴⁾ UNV =Universal Voltage 120-277 120V =120 Volt ⁽⁵⁾ 277V =277 Volt ⁽⁵⁾	EL7W =7-watt, 120V-277V emergency battery pack installed ⁽⁶⁾ EL14W =14-watt 120V-277V emergency battery pack installed ⁽⁶⁾ GTR2 =Bodine Generator Transfer Relay ^{(7),(8)} ETRD =Iota Emergency Transfer Relay with dimming control ⁽⁷⁾	L830 =3000K L835 =3500K L840 =4000K L930 =3000K L935 =3500K L940 =4000K L83050 =80CRI 3000K-5000K White Tuning ⁽⁹⁾ L93050 =90CRI 3000K-5000K White Tuning ⁽⁹⁾ L82765 =80CRI 2700K-6500K White Tuning ⁽⁹⁾ L92765 =90CRI 2700K-6500K White Tuning ⁽⁹⁾
Notes (1) Only product configurations with these designated prefixes are built to be compliant with the Buy American Act of 1933 (BAA) or Trade Agreements Act of 1979 (TAA), respectively. Please refer to DOMESTIC PREFERENCES website for more information. Components shipped separately may be separately analyzed under domestic preference requirements.	Notes (2) DesignLights Consortium [®] Qualified and classified for both DLC Standard and DLC Premium, refer to www.designlights.org for details.	Notes (3) Products also available in non-US voltages and frequencies for international markets. (4) 347V versions are not available with emergency options. (5) Must specify voltage as 120V or 277V when ordering GTR2 option.	Notes (6) With integral test switch/indicator/laser test. For approximate delivered lumens multiply the lumens per watt of the desired fixture by the wattage of the emergency battery pack (100 lm/W x 7=700 lumens). IES-format photometry for luminaire under emergency operation available. (7) Used to bypass local control during outage. Must be used in conjunction with UL 1008 device (provided by others). GTR2 option includes 2 relays on fixtures with dimming drivers. ETRD option only requires one relay when used on a dimming fixture. (8) Must specify voltage as 120V or 277V when ordering GTR2 option.	Notes (9) White tuning correlated color temperatures (CCT) between 3000K (warm) to 5000K (cool) or 2700K (warm) to 6500K (cool). Must be used in conjunction with W2A driver only. Must be used with two (2) 10V dimming control channels, 1 color, 1 intensity.					

Factory Wiring	Driver Type	Number of Drivers	Integrated Sensing Systems	Packaging	Accessories
A3/8-4/18GDIM =3/8" Flex with 0-10V Dimming Leads. Multiple other configurations available. See below for details. A3/8-5/18GDIM =Flex with 0-10V Dimming Leads and Blue for alternate wiring. See below for details.	CD =0-10V Driver (1%-100% Dimming) 5LTD =DALI Driver (5%-100% Dimming) ⁽¹⁰⁾ 5LTHD =DALI Driver (1%-100% Dimming) SD =Step Dimming Driver (50% or 100% Dimming) ⁽¹¹⁾ LH =Lutron HiLume (LDE1 series) 1%-100% EcoSystem Driver with Soft-on Fade to Black dimming ^(F) W2A =White Tuning, 2 ch, Intensity and CCT Control ⁽¹¹⁾ SR =Sensor-ready Driver (1%-100% Dimming)	1=1 Driver 2=2 Drivers	[Blank] =No Sensor WLS (formerly WAB) =WaveLinX LITE Wireless Sensor, Occupancy w/ photocell, Independent & Networked ^{(13),(8)} WPS (formerly WAA) =WaveLinX PRO Wireless Sensor, Occupancy w/ photocell, Networked ^{(12),(4)} WLN =WaveLinX LITE Wireless Control Node, without sensor ^{(12),(8)} WPN =WaveLinX PRO Wireless Control Node, without sensor ^{(12),(4)}	U =Unit Pack PALC =Job Pack, in carton	EQ-CLIP-U =T-BAR Safety Earthquake Clips ⁽¹⁴⁾ DF-24U =2' x 4' Drywall Frame Kit SK-24-WS =Field Install Surface Mount Kit, Shallow SK-24-WT =Field Install Surface Mount Kit, Tall
Flexible Metal Conduit Options Flex options available for 0-10V dimming control, DALI dimming control, emergency and night light functions. 72-inch factory-installed and pre-wired to driver, fitted to luminaire housing access plate with 90° enclosed FMC connector. Not all options may be combined and installation ratings vary by type. A3/8-4/18GDIM series notes: Factory installed dimming option 3/8" flexible metal conduit with 2-#18 power and ground wires and 2-#18 UL-listed jacketed 0-10V +/- control wires. Meets UL 66, 83, 1479, 1569, 1581, 2556. NEC® 250.118, 300.22(C), 392, 396, 330, 501, 502, 503, 530, 504, 505, 518, 520, 530, 645, 72; Federal Specification A-A-59544 (formerly J-C-30B); all applicable OSHA and HUD Requirements. UL Classified 1-, 2-, and 3-hour through penetration with applicable fire stop product (not included). May be surface mounted, fished and/or embedded in plaster. Cable tray and approved raceway rated, install per NEC®; Environmental Air-Handling Space Installation per NEC® 300.22(C).	Notes (10) 3100 and 3600 Lumen packages not available with Step-Dim (SD) and DALI (5LTD) driver option. (11) White tuning provides correlated color temperatures (CCT) between 3000K (warm) to 5000K (cool) or 2700K (warm) to 6500K (cool). Must be used in conjunction with W2A driver only. Must be used with two (2) 10V dimming control channels, 1 color, 1 intensity. Integrated options must be used in conjunction with the associated system and may not be compatible with other options or accessories. Please refer to the following: (F) Consult Marketplace Options - Lutron system pages for additional details and compatibility. Compatible only with driver series shown, and may require two or more drivers. Requires field commissioning to operate or dim. Contact Lutron at www.lutron.com .	Notes (12) WPS sensor and WPN node to be used with CD or W2A driver. (13) WLS sensor and WLN to be used with CD driver. Integrated options must be used in conjunction with the associated system and may not be compatible with other options or accessories. Please refer to the following: (A) Consult WaveLinX PRO system pages for additional details and compatibility. (B) Consult WaveLinX LITE system pages for additional details and compatibility.	Notes (14) An EQ Grid Clip is recommended for all 9/16" ceiling systems. Four required per fixture. (15) Accessories sold separately will be separately analyzed under domestic preference requirements. Consult factory for further information. Integrated options must be used in conjunction with the associated system and may not be compatible with other options or accessories.		

Product Specifications

Construction

- 5-5/8" housing constructed of die-formed, code gauge cold rolled steel
- Full length die-formed stiffeners and unibody endplate for added strength
- Four auxiliary fixture end suspension points provided
- Wireway cover removable without tools
- Endplates provided with Grid-Lock feature for safety
- These fixtures may have MWS (Modular Wiring System) added. Consult factory for details.

Integrated Controls

- 0-10V dimming to 1% standard
- Integrated WaveLinX options provide wireless individual fixture control and enable code compliance, increased energy savings, grouping of fixtures, and connection to WaveLinX control systems
- DALI 2.0, Lutron, and step-dimming available

LED and Light Engine

- LED's available in 3000K, 3500K, or 4000K at 80 CRI minimum and 90 CRI minimum
- Color accuracy \leq 3-Step MacAdam ellipse (SDCM)
- TM21 life at 60,000 hours up to L92 and calculated L70 exceeds 290,000 hrs.
- Drivers available in 120-277V and 347V
- Tunable white options available with Cooper Lighting Solutions' VividTune

Emergency Battery Options

- Optional 120-277V emergency battery available in 7W or 14W
- 90-minute backup period for code compliance
- Test switch with laser pointer and testing from floor feature for ease of use
- EZ Key feature prevents accidental discharge during construction
- Generator transfer options available

Finish

- Multistage, iron phosphate pretreatment
- 90% reflective, matte white enamel finish
- Full fixture housing painted after fabrication

Hinging/Latching

- Positive cam action steel latches with baked white enamel finish
- Safety-lock T-hinges allow hinging and latching either side
- Door assembly hinges down for easy access to driver and LEDs from below

Frame/Sheilding

- Die formed, heavy gauge flat steel door
- Mitered corners and painted after fabrication
- Baked matte white enamel finish
- Positive light seals
- Acrylic frosted lens

Compliance

- IC rated for insulation contact
- cULus listed for damp locations
- RoHS compliant
- Tested to IESNA LM-79 and LM-80
- Stated life tested to TM21 standards
- Can be used for State of California Title 24 high efficacy luminaire

Limited Warranty

- Five year limited warranty standard. Optional ten year limited warranty available.

Photometric Data

 View IES files

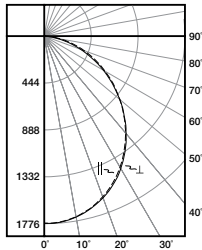

24RLN-LD5-45-UNV-L835-CD1-U
 Electronic Driver
 Linear LED 3500K
 Spacing criterion: (||) 1.2 x mounting height,
 (⊥) 1.21 x mounting height
 Lumens: 4547.1
 Input Watts: 34W
 Efficacy: 133.7 lm/W
 Test Report: 24RLN-LD5-45-UNV-L835-CD1-U.
 IES

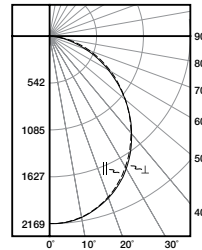

24RLN-LD5-55-UNV-L835-CD1-U
 Electronic Driver
 Linear LED 3500K
 Spacing criterion: (||) 1.2 x mounting height,
 (⊥) 1.21 x mounting height
 Lumens: 5554.0
 Input Watts: 42.7W
 Efficacy: 130.1 lm/W
 Test Report: 24RLN-LD5-55-UNV-L835-CD1-U.
 IES

Energy and Performance Data

Stock or MTO	Catalog Logic (Rectilinear Shielding)	Delivered Lumens	Watts	Efficacy (lm/W)
MTO	24RLN-LD5-31-UNV-L830-CD1-U	3052	22.9	133
MTO	24RLN-LD5-31-UNV-L835-CD1-U	3179	22.9	139
MTO	24RLN-LD5-31-UNV-L840-CD1-U	3179	22.9	139
MTO	24RLN-LD5-36-UNV-L830-CD1-U	3505	26.5	132
MTO	24RLN-LD5-36-UNV-L835-CD1-U	3651	26.5	138
MTO	24RLN-LD5-36-UNV-L840-CD1-U	3651	26.5	138
MTO	24RLN-LD5-42-UNV-L830-CD1-U	4040	31.2	129
MTO	24RLN-LD5-42-UNV-L835-CD1-U	4208	31.2	135
MTO	24RLN-LD5-42-UNV-L840-CD1-U	4208	31.2	135
MTO	24RLN-LD5-45-UNV-L830-CD1-U	4365	34.0	128
STOCK	24RLN-LD5-45-UNV-L835-CD1-U	4547	34.0	134
STOCK	24RLN-LD5-45-UNV-L840-CD1-U	4547	34.0	134
MTO	24RLN-LD5-50-UNV-L830-CD1-U	4800	37.8	127
MTO	24RLN-LD5-50-UNV-L835-CD1-U	5000	37.8	132
MTO	24RLN-LD5-50-UNV-L840-CD1-U	5000	37.8	132
MTO	24RLN-LD5-55-UNV-L830-CD1-U	5332	42.7	125
STOCK	24RLN-LD5-55-UNV-L835-CD1-U	5554	42.7	130
STOCK	24RLN-LD5-55-UNV-L840-CD1-U	5554	42.7	130
MTO	24RLN-LD5-60-UNV-L830-CD1-U	5759	47.7	121
MTO	24RLN-LD5-60-UNV-L835-CD1-U	5999	47.7	126
MTO	24RLN-LD5-60-UNV-L840-CD1-U	5999	47.7	126
MTO	24RLN-LD5-67-UNV-L830-CD1-U	6485	53.9	120
MTO	24RLN-LD5-67-UNV-L835-CD1-U	6755	53.9	125
MTO	24RLN-LD5-67-UNV-L840-CD1-U	6755	53.9	125
MTO	24RLN-LD5-74-UNV-L830-CD1-U	7136	61.6	116
MTO	24RLN-LD5-74-UNV-L835-CD1-U	7433	61.6	121
MTO	24RLN-LD5-74-UNV-L840-CD1-U	7433	61.6	121
MTO	24RLN-LD5-80-UNV-L830-CD1-U	7735	67.5	115
MTO	24RLN-LD5-80-UNV-L835-CD1-U	8057	67.5	119
MTO	24RLN-LD5-80-UNV-L840-CD1-U	8057	67.5	119

Lumen Maintenance

Ambient Temperature	TM-21 Lumen Maintenance (60,000 hours) ⁽¹⁾	Theoretical L70 (hours) ⁽²⁾
25°C	> 93%	> 351,000

Notes: (1) Supported by IES TM-21 standards. (2) Theoretical values represent estimations commonly used; however, refer to the IES position on LED Product Lifetime Prediction, IES PS-10-18, that explains proper use of IES TM-21 and LM-80.

90 CRI

Lumen Adjustment Factors 80->90 CRI	
3000K	0.865
3500K	0.861
4000K	0.883
5000K	n.a.

Example of Lumen Adjustment Calculation

24RLN-LD5-45-UNV-L935-CD1-U
 at 90CRI at 3500K

Lumen Adjustment Factor = 0.861

Total Light Output =

$$4,547 \text{ lm} \times 0.861 = 3,914 \text{ lm}$$

$$\text{Efficacy} = \frac{3,914 \text{ lm}}{34 \text{ W}} = 115.1 \text{ lm/W}$$

Shipping Data

Catalog No.	Wt.
24RLN-LD5-45	22.5 lbs.
24RLN-LD5-55	22.5 lbs.

Control Solutions

- WaveLinX LITE wireless
- WaveLinX PRO wireless
- WaveLinX CAT wired
- WaveLinX Wired



The RLN with WaveLinX offers no-hassle lighting control with multiple luminaire level control solutions.



WaveLinX PRO is a wireless lighting control solution, for connected spaces, that significantly reduces a building's energy consumption. From a single floor to an entire campus, WaveLinX PRO connects more than lighting assets; it shares aggregated sensor data with the WaveLinX CORE platform and other building systems, so building owners can improve operations, spaces environment, and tenants' experience. WaveLinX PRO offers a rich portfolio of wireless devices, WaveLinX PRO-enabled luminaires, and an intuitive WaveLinX mobile app for office, education, warehouse, and parking garage applications.



WaveLinX LITE is a cost effective, wireless digital lighting control solution, with out-of-the-box functionality, that saves energy and meets code. It's designed for applications that require occupancy-based, daylighting, or manual light control. Customize installations for office, education, warehouse and parking garages using the secure, simple mobile app.

Integrated Sensor Coverage Pattern

TOP VIEW:

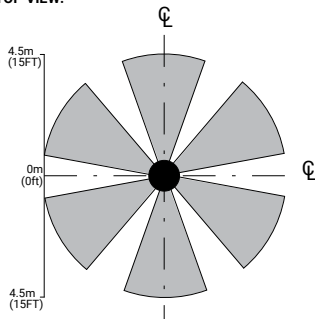

SIDE VIEW:

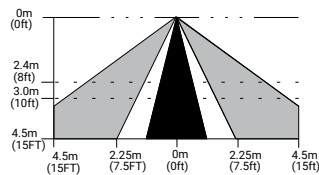

Note: Installation of integrated sensors within 3-ft (1m) of HVAC air vents is not recommended. The pattern shown is intended solely as a general guide and is not to scale.

With Integrated WaveLinX Sensor

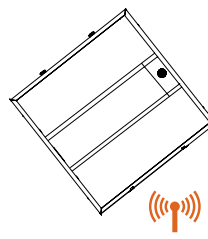

With Integrated WaveLinX Node

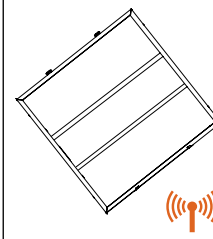

Add a hidden WaveLinX sensor node (WPN, WLN) to your space lighting design!

Allows to:

- Keeps luminaire aesthetics
- Connect fixtures without the realstate to include sensor option such as downlights
- Connect sealed fixtures without a standard sensor option such as products for clinical space.

Integrated Controls Options

Option	Out of the Box Functionality	Luminaire Level Lighting Control (LLC)	Automatic Dimming Photocell	Occupancy Sensing	CCT Control
WLS	X	X	X	X	
WLN		X			
WPS		X	X	X	X
WPN		X			X

Note: WaveLinX utilizes scenes to allow users to change an area's fixtures Correlated Color Temperature (CCT) and intensity using commissioned manual wireless wallstation scene control. To enable CCT adjustments through WaveLinX, include WPS or WPN devices in addition to VividTune or BioUp technologies for integrated fixture control.

Systems comparison chart

Cooper Lighting Solutions provides many lighting system solutions designed to satisfy code requirements and meet the unique needs of any project.



Luminaire with standalone sensor

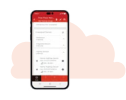

Standalone Spaces WaveLinX LITE



Standalone Spaces WaveLinX CAT



Networked Spaces WaveLinX PRO



Enterprise WaveLinX CORE

	Luminaire with standalone sensor	Standalone Spaces WaveLinX LITE	Standalone Spaces WaveLinX CAT	Networked Spaces WaveLinX PRO	Enterprise WaveLinX CORE
Occupancy	Yes	Yes	Yes	Yes	Yes
Daylighting	Yes	Yes	Yes	Yes	Yes
Wallstations	-	Yes	Yes	Yes	Yes
Gateways	-	-	-	1 WAC	300 WACs
Devices (MAX)	-	40 per Area (1120 per space)	40 per Area	200 per WAC2	32,500 per CORE Enterprise
Software	-	WaveLinX LITE Mobile App	WaveLinX CAT Mobile App	WaveLinX Mobile App	CORE
Areas	-	28 per Space	Unlimited	50 per WAC2	up to 3,000
Zones	-	16 per Area	16 per Area	16 per Area	up to 9,000
Scheduling	-	-	-	Local	Global
VividTune™	-	-	-	Yes	Yes
Plug-Load Control	-	Yes	Yes	Yes	Yes
Low-Voltage Power	-	-	Yes	Yes	Yes
Integration	-	-	-	-	BACnet, API
Dashboards	-	-	-	-	Energy, Occupancy
Configuration	-	Installer	Installer	Technician	Technician / IT



24RLN LED with VividTune Tunable White

VividTune tunable white luminaires from Cooper Lighting Solutions deliver high-quality light in a broad range of continuously variable color temperatures and intensities. Create a dynamic environment by adjusting the ambient light warmer or cooler to influence mood, support the task at hand, or create a dramatic ambience. The ability to control correlated color temperature and intensity separately using simple controls is the next evolution of LED lighting for the commercial, educational, healthcare and hospitality space. The unparalleled flexibility and number of available lighting environments enable users to find the right light with tunable white.

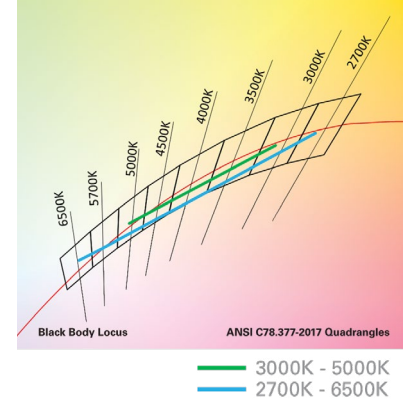

Performance Data*

Tunable White - Lumen Adjustment Factors (example only)				
CCT	3000K-5000K		2700K-6500K	
	80 CRI	90 CRI	80 CRI	90 CRI
2700K	-	-	0.923	0.789
3000K	0.950	0.783	0.949	0.820
3500K	1.006	0.855	0.983	0.861
4000K	1.056	0.923	1.004	0.888
4500K	1.066	0.939	1.022	0.911
5000K	1.066	0.939	1.036	0.929
6500K	-	-	1.051	0.955

2' x 4' RLNLED - Example of Approximate Lumen Calculation			
	Standard Catalog #	VividTune 80 CRI Catalog #	VividTune 90 CRI Catalog #
CCT Setting	24RLN-LD5-45-UNV-L835-CD1-U	24RLN-LD5-45-UNV-L83050-W2A1-U	24RLN-LD5-45-UNV-L93050-W2A1-U
3000K	-	4320	3560
3500K	4547	4574	3888
4000K	-	4802	4197
4500K	-	4847	4270
5000K	-	4847	4270

Controlling VividTune Tunable White

VividTune luminaires make tunable white more accessible by using simple and familiar controls. From wall dimmers to wireless controls, VividTune tunable white luminaires are compatible with industry standard 0-10V dimming controls. A single 0-10V dimming input is used to control intensity (brightness) while a second 0-10V dimming input is used to adjust CCT. For suggested control configurations, go to www.cooperlighting.com for tunable white application guides.

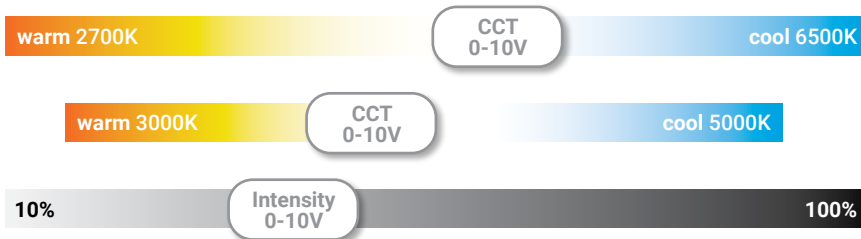

Example of Lumen Adjustment Calculation

24RLN-LD5-45-UNV-L83050-W2A1-U at 80 CRI tuned to 3500K

$$\text{Adjusted Lumen} = \text{published lm} \times \text{adjusted lm factor}$$

$$\text{Adjusted Lumen} = 4547 \times 1.006$$

$$\text{Adjusted Lumen} = 4574 \text{ lm}$$

* Lumen adjustment factors are for reference and may be different for each product selected. Refer to IES files for actual performance data on each.