

Project		Catalog #		Type	
Prepared by		Notes		Date	



Metalux

Accord 24AC LED

2' x 4' Specification Grade LED Troffer

Typical Applications

Office • Education • Healthcare • Retail

Interactive Menu

- Order Information [page 2](#)
- Photometric Data [page 3](#)
- Control Solutions [page 5](#)
- Product Warranty

Product Certification



Product Features



Top Product Features

- Available in 1' x 4', 2' x 2' and 2' x 4' recessed & surface versions
- Advanced optical control
- High performance efficacy up to 127 lumens per watt
- Over 60% energy savings when compared to fluorescent troffers
- Three CCT options: 3000K, 3500K and 4000K at 85 CRI
- Options to meet Buy American and other domestic preference requirements

Dimensional and Mounting Details

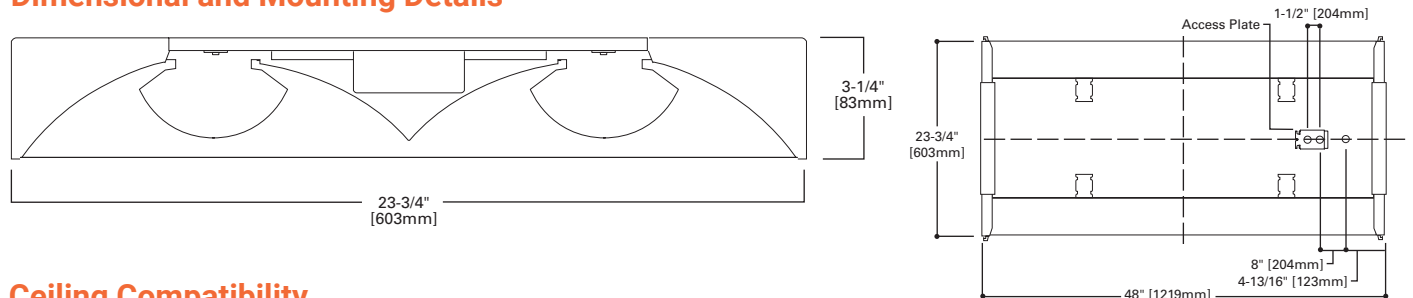

NOTE: 2' x 2' and 2' x 4' allow for row mounting

Ceiling Compatibility

G	F	Ceiling Type**	Trim Type
Grid/Lay-in Standard	Drywall Frame Kit	Exposed Grid	G
		Concealed T	G or T
		Slot Grid	G or T
		Flange	***

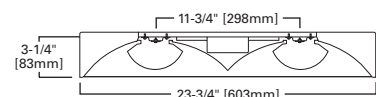

Order Information

SAMPLE ORDER NUMBER: **24AC-LD5-55-UNV-L835-CD1-U**

Domestic Preferences	Rating	Series	Type	Lamp Type	Lumen Outputs	Shielding	Voltage
Domestic Preferences ⁽¹⁾	Rating	Series ⁽²⁾	Type	Lamp Type	Lumen Outputs	Shielding	Voltage ⁽⁵⁾
[Blank]=Standard BAA=Buy American Act TAA=Trade Agreements Act	[Blank]=Standard ATW-SW4=Chicago Rated	24AC=2x4 Accord Series	[Blank]=Standard A=Air (vented) ⁽³⁾	LD5=LED 5.0	Stock Lumen Outputs 44=4400 Lumens 55=5500 Lumens MTO Lumen Outputs 31=3100 Lumens ⁽⁴⁾ 36=3600 Lumens 39=3900 Lumens 48=4800 Lumens 63=6300 Lumens 68=6800 Lumens 73=7300 Lumens	[Blank]=Standard Lens	UNV=Universal Voltage 120-277 347V=347 Volt ⁽⁶⁾ 120V=120 Volt ⁽⁷⁾ 277V=277 Volt ⁽⁷⁾
Notes (1) Only product configurations with these designated prefixes are built to be compliant with the Buy American Act of 1933 (BAA) or Trade Agreements Act of 1979 (TAA), respectively. Please refer to DOMESTIC PREFERENCES website for more information. Components shipped separately may be separately analyzed under domestic preference requirements.		Notes (2) DesignLights Consortium® Qualified and classified for both DLC Standard and DLC Premium, refer to www.designlights.org for details.	Notes (3) Air versions are not designed for continuous row mount applications. Air version is vented but does not meet air handling requirements.		Notes (4) 3100 and 3600 lumen options not available with Step-dim driver and with Fifth Light drivers (SLTD and SLTHD).		Notes (5) Products also available in non-US voltages and frequencies for international markets. (6) 347V emergency option not available with emergency options. (7) Must specify voltage as 120V or 277V when ordering GTR2 option.

Emergency Options	CCT	Flex	Driver Type
Emergency Options	CCT	Flex	Driver Type
EL7W=EL7W=7-watt 120V-277V emergency battery pack ⁽⁸⁾ EL10W=10-watt 120V-277V emergency battery pack ⁽⁸⁾ EL14W=14-watt 120V-277V emergency battery pack ⁽⁸⁾ EL10WSD=10W emergency battery pack with self-diagnostic installed ^{(8), (11)} EL14WSD=14W emergency battery pack with self-diagnostic installed ^{(8), (11)} GTR2=Bodine Generator Transfer Relay ^{(9), (10)} ETRD=Emergency Transfer Relay with dimming control ⁽⁹⁾	L830=3000K L835=3500K L840=4000K	A3/8-4/18GDIM=3/8" Flex with 0-10V Dimming Leads See below for details. A3/8-5/18GDIM=Flex with 0-10V Dimming leads and Blue for alternate wiring. See below for details.	CD=0-10V Dimming Driver (1%-100% Dimming) SR=Sensor-ready Dimming Driver (1%-100% Dimming) SLTD=Fifth Light DALI Driver (10%-100% Dimming) ⁽⁵⁾ SLTHD=Fifth Light Dimming Driver (1%-100% Dimming) ^{(12), (5)} SD=Step Dimming Driver (50%-100% Dimming) ⁽¹²⁾ LH=Lutron HiLume (LDE1 series) 1%-100% EcoSystem Driver with Soft-on Fade to Black dimming ⁽⁷⁾
Notes (8) Factory installed with integral test switch/indicator/laser test. For approximate delivered lumens multiply the lumens per watt of the desired fixture by the wattage of the emergency battery pack (100 lm/W x 7=700 lumens). IES-format photometry for luminaire under emergency operation available. Battery option increases total height by 1 inch. (9) Used to bypass local control during outage. Must be used in conjunction with UL 1008 device (provided by others). GTR2 option includes 2 relays on fixtures with dimming drivers. ETRD option only requires one relay when used on a dimming fixture. (10) Must specify voltage as 120V or 277V when ordering GTR2 option. (11) EL10WSD and EL14WSD not available with 347V.		Flexible Metal Conduit Options Flex options available for 0-10V dimming control, DALI dimming control, emergency and night light functions. 72-inch factory-installed and pre-wired to driver, fitted to luminaire housing access plate with 90° enclosed FMC connector. Not all options may be combined and installation ratings vary by type. A3/8-4/18GDIM series notes: Factory installed dimming option 3/8" flexible metal conduit with 2-#18 power and ground wires and 2-#18 UL-listed jacketed 0-10V +/- control wires. Meets UL 66, 83, 1479, 1569, 1581, 2556, NEC® 250.118, 300.22(C), 392, 396, 330, 501, 502, 503, 530, 504, 505, 518, 520, 530, 645, 72; Federal Specification A-A-59544 (formerly J-C-30B); all applicable OSHA and HUD Requirements. UL Classified 1-, 2-, and 3-hour through penetration with applicable fire stop product (not included). May be surface mounted, fished and/or embedded in plaster. Cable tray and approved raceway rated, install per NEC®; Environmental Air-Handling Space Installation per NEC® 300.22(C).	Notes (12) 3100 and 3600 lumen options not available with Step-dim driver and with Fifth Light drivers (SLTD and SLTHD). Integrated options must be used in conjunction with the associated system and may not be compatible with other options or accessories. Please refer to the following: (5) Consult Fifth Light system pages for additional details and compatibility. (7) Consult Marketplace Options - Lutron system pages for additional details and compatibility. Compatible only with driver series shown, and may require two or more drivers. Requires field commissioning to operate or dim. Contact Lutron at www.lutron.com .

Number of Drivers	Integrated Sensing Systems	Packaging	Accessories
Number of Drivers	Integrated Sensing Systems	Packaging	Accessories (order separately) ⁽¹²⁾
1=1 Driver 2=2 Drivers	[Blank]=No Sensor WPS (formerly WAA)=WaveLinX PRO Wireless Sensor, Occupancy w/ photocell, Networked ^(A)	U=Unit Pack PALC=Job Pack, in carton	T3A END E.Q. BRACKET PARTS BAG DF-24W-U=2' x 4' Drywall Frame Kit SK-24-WS=2' x 4' Shallow Surface Mount Kit SK-24-WT=2' x 4' Tall Surface Mount Kit
	Notes Integrated options must be used in conjunction with the associated system and may not be compatible with other options or accessories. Please refer to the following: (A) Consult WaveLinX system pages for additional details and compatibility.		Notes (12) Accessories sold separately will be separately analyzed under domestic preference requirements. Consult factory for further information.

Product Specifications

Construction

- Shallow 3-1/4" deep housing is die-formed of code gauge, prime cold rolled steel
- Heavy gauge endplates are securely attached with screws for strength and rigidity and the elimination of gaps
- End plates have integral grid-lock feature for safety and convenience
- Four auxiliary fixture end suspension points provided
- Large access plate for supply connection
- Driver can be accessed from below without tools

Integrated Controls

- 0-10V dimming to 1% standard
- Integrated WaveLinX options provide wireless individual fixture control and enable code compliance, increased energy savings, grouping of fixtures, and connection to WaveLinX control systems
- DALI 2.0, Lutron, and step-dimming available

Electrical

- LED's available in 3000K, 3500K or 4000K with a minimum CRI of 80
- Color accuracy \leq 3-Step MacAdam ellipse (SDCM)
- Projected life is 60,000 hours at 89% lumen output
- Electronic drivers available for 120-277V and 347V applications

Emergency Battery Options

- 120V-277V integral emergency battery pack comes in 7-watts, 10-watt, or 14-watts
- Self-diagnostic emergency battery available in 10 or 14-watts (NFPA 101@ Life Safety Code@)
- Constant power to the LED system for controlled, predictable discharge
- Integrated test switch/indicator light visible from floor
- Min. 90-minute backup period for code compliance
- Integral emergency transfer relay available for generator equipped power systems

Finish

- Multistage, iron phosphate pretreatment ensure maximum bonding and rust inhibition
- White enamel finish

Reflectors

- High reflectance baked matte white enamel finish for luminous uniformity

Shielding

- Positively retained frosted acrylic profile lenses provide a soft but effective distribution of light

Compliance

- Modules are UL recognized components
- Indoor luminaires are cULus listed for 25°C ambient environments
- Complies with IESNA LM-79
- LEDs compliant with LM-80 standards
- DesignLights Consortium® Qualified and classified for both DLC Standard and DLC Premium, refer to www.designlights.org for details.

Limited Warranty

- Five-year limited warranty standard. Optional ten year limited warranty available.

Photometric Data

[View IES files](#)

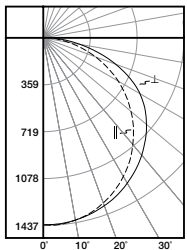

24AC-LD5-44-UNV-L835-CD1-U

Electronic Driver
 Linear LED 3500K
 Spacing criterion: (||) 1.26 x mounting height,
 (⊥) 1.32 x mounting height
 Lumens: 4496
 Input Watts: 37.9W
 Efficacy: 118.6 LPW
 Test Report: 24AC-LD5-44-UNV-L835-CD1-U.IES

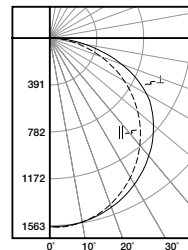

24AC-LD5-48-UNV-L835-CD1-U

Electronic Driver
 Linear LED 3500K
 Spacing criterion: (||) 1.26 x mounting height,
 (⊥) 1.32 x mounting height
 Lumens: 4892
 Input Watts: 41.9W
 Efficacy: 116.7 LPW
 Test Report: 24AC-LD5-48-UNV-L835-CD1-U.IES

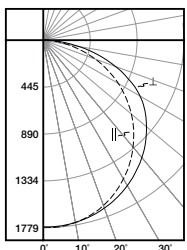

24AC-LD5-55-UNV-L835-CD1-U

Electronic Driver
 Linear LED 3500K
 Spacing criterion: (||) 1.26 x mounting height,
 (⊥) 1.32 x mounting height
 Lumens: 5567
 Input Watts: 49.1W
 Efficacy: 113.4 LPW
 Test Report: 24AC-LD5-55-UNV-L835-CD1-U.IES

Energy and Performance Data

Stock or MTO	Catalog Logic (Curved)	Delivered Lumens	Watts	Efficacy (LPW)
MTO	24AC-LD5-31-UNV-L830-CD1-U	3035	25.4	119
MTO	24AC-LD5-31-UNV-L835-CD1-U	3155	25.4	124
MTO	24AC-LD5-31-UNV-L840-CD1-U	3218	25.4	127
MTO	24AC-LD5-36-UNV-L830-CD1-U	3539	30.1	118
MTO	24AC-LD5-36-UNV-L835-CD1-U	3679	30.1	122
MTO	24AC-LD5-36-UNV-L840-CD1-U	3753	30.1	125
MTO	24AC-LD5-39-UNV-L830-CD1-U	3835	32.9	116
MTO	24AC-LD5-39-UNV-L835-CD1-U	3987	32.9	121
MTO	24AC-LD5-39-UNV-L840-CD1-U	4067	32.9	123
MTO	24AC-LD5-44-UNV-L830-CD1-U	4325	37.9	114
Stock	24AC-LD5-44-UNV-L835-CD1-U	4496	37.9	119
Stock	24AC-LD5-44-UNV-L840-CD1-U	4586	37.9	121
MTO	24AC-LD5-48-UNV-L830-CD1-U	4705	41.9	112
MTO	24AC-LD5-48-UNV-L835-CD1-U	4892	41.9	117
MTO	24AC-LD5-48-UNV-L840-CD1-U	4990	41.9	119
MTO	24AC-LD5-55-UNV-L830-CD1-U	5355	49.2	109
Stock	24AC-LD5-55-UNV-L835-CD1-U	5567	49.2	113
Stock	24AC-LD5-55-UNV-L840-CD1-U	5678	49.2	116
MTO	24AC-LD5-63-UNV-L830-CD1-U	6069	57.8	105
MTO	24AC-LD5-63-UNV-L835-CD1-U	6310	57.8	109
MTO	24AC-LD5-63-UNV-L840-CD1-U	6436	57.8	111
MTO	24AC-LD5-68-UNV-L830-CD1-U	6541	65.1	101
MTO	24AC-LD5-68-UNV-L835-CD1-U	6800	65.1	105
MTO	24AC-LD5-68-UNV-L840-CD1-U	6936	65.1	107
MTO	24AC-LD5-73-UNV-L830-CD1-U	7014	71.0	99
MTO	24AC-LD5-73-UNV-L835-CD1-U	7292	71.0	103
MTO	24AC-LD5-73-UNV-L840-CD1-U	7438	71.0	105

Lumen Maintenance

Ambient Temperature	TM-21 Lumen Maintenance (60,000 hours) ⁽¹⁾	Theoretical L70 (Hours) ⁽²⁾
25°C	> 89%	> 193,000

Notes: (1) Supported by IES TM-21 standards. (2) Theoretical values represent estimations commonly used; however, refer to the IES position on LED Product Lifetime Prediction, IES PS-10-18, that explains proper use of IES TM-21 and LM-80.

Shipping Data

Catalog No.	Wt.
24AC-LD5-44	21 lbs.
24AC-LD5-55	21 lbs.

Control Solutions

- WaveLinX LITE wireless
- WaveLinX PRO wireless
- WaveLinX CAT wired
- WaveLinX Wired



The Accord LED with WaveLinX offers no-hassle lighting control with multiple luminaire level control solutions.



WaveLinX PRO is a wireless lighting control solution, for connected spaces, that significantly reduces a building's energy consumption. From a single floor to an entire campus, WaveLinX PRO connects more than lighting assets; it shares aggregated sensor data with the WaveLinX CORE platform and other building systems, so building owners can improve operations, spaces environment, and tenants' experience. WaveLinX PRO offers a rich portfolio of wireless devices, WaveLinX PRO-enabled luminaires, and an intuitive WaveLinX mobile app for office, education, warehouse, and parking garage applications.



WaveLinX LITE is a cost effective, wireless digital lighting control solution, with out-of-the-box functionality, that saves energy and meets code. It's designed for applications that require occupancy-based, daylighting, or manual light control. Customize installations for office, education, warehouse and parking garages using the secure, simple mobile app.

Integrated Sensor Coverage Pattern

TOP VIEW:

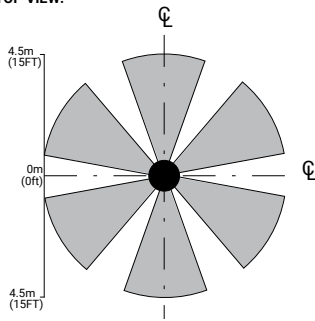

SIDE VIEW:

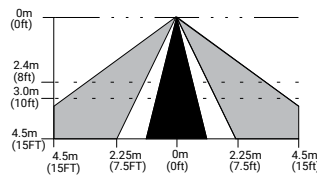

With Integrated WaveLinX Sensor

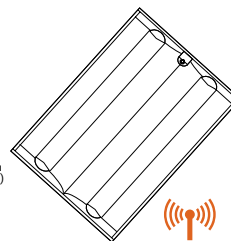

With Integrated WaveLinX Node

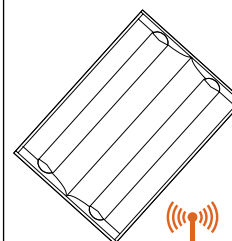

Add a hidden WaveLinX sensor node (WPN, WLN) to your space lighting design!

Allows to:

- Keeps luminaire aesthetics
- Connect fixtures without the realstate to include sensor option such as downlights
- Connect sealed fixtures without a standard sensor option such as products for clinical space.

Note: Installation of integrated sensors within 3-ft (1m) of HVAC air vents is not recommended. The pattern shown is intended solely as a general guide and is not to scale.

Integrated Controls Options

Option	Out of the Box Functionality	Luminaire Level Lighting Control (LLC)	Automatic Dimming Photocell	Occupancy Sensing	CCT Control
WLS	X	X	X	X	
WLN		X			
WPS		X	X	X	X
WPN		X			X

Note: WaveLinX utilizes scenes to allow users to change an area's fixtures Correlated Color Temperature (CCT) and intensity using commissioned manual wireless wallstation scene control. To enable CCT adjustments through WaveLinX, include WPS or WPN devices in addition to VividTune or BioUp technologies for integrated fixture control.

Systems comparison chart

Cooper Lighting Solutions provides many lighting system solutions designed to satisfy code requirements and meet the unique needs of any project.



Luminaire with standalone sensor

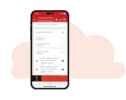

Standalone Spaces WaveLinX LITE



Standalone Spaces WaveLinX CAT



Networked Spaces WaveLinX PRO



Enterprise WaveLinX CORE

	Luminaire with standalone sensor	Standalone Spaces WaveLinX LITE	Standalone Spaces WaveLinX CAT	Networked Spaces WaveLinX PRO	Enterprise WaveLinX CORE
Occupancy	Yes	Yes	Yes	Yes	Yes
Daylighting	Yes	Yes	Yes	Yes	Yes
Wallstations	-	Yes	Yes	Yes	Yes
Gateways	-	-	-	1 WAC	300 WACs
Devices (MAX)	-	40 per Area (1120 per space)	40 per Area	200 per WAC2	32,500 per CORE Enterprise
Software	-	WaveLinX LITE Mobile App	WaveLinX CAT Mobile App	WaveLinX Mobile App	CORE
Areas	-	28 per Space	Unlimited	50 per WAC2	up to 3,000
Zones	-	16 per Area	16 per Area	16 per Area	up to 9,000
Scheduling	-	-	-	Local	Global
VividTune™	-	-	-	Yes	Yes
Plug-Load Control	-	Yes	Yes	Yes	Yes
Low-Voltage Power	-	-	Yes	Yes	Yes
Integration	-	-	-	-	BACnet, API
Dashboards	-	-	-	-	Energy, Occupancy
Configuration	-	Installer	Installer	Technician	Technician / IT