

Project		Catalog #		Type	
Prepared by		Notes		Date	



# HALO Commercial

## HC4 | HM4 | 41/41PS

4-inch LED downlight and wall wash

### Typical Applications

Office • Healthcare • Hospitality • Institutional • Mixed-Use/Retail

### Interactive Menu

- Order Information [page 2](#)
- Product Specifications [page 4](#)
- Photometric Data [page 5](#)
- Energy & Performance Data [page 8](#)
- Connected Systems [page 10](#)
- Product Warranty

### Top Product Features

- New construction/remodel series; 500 to 6,000 lumens
- Narrow, Medium and Wide distributions; Wall wash with rotatable linear spread lens
- 2700K, 3000K, 3500K, 4000K and 5000K CCT; 80 or 90 CRI
- Universal voltage 120V-277V; Standard 0-10V driver dims to 1%
- Mounting frame converts to remodel that installs from below the ceiling
- Quick Spec emergency backup mounting frames - fast delivery option

### Product Certification



### Product Features



### Control Compatibility



### Dimensional and Mounting Details

additional product diagrams

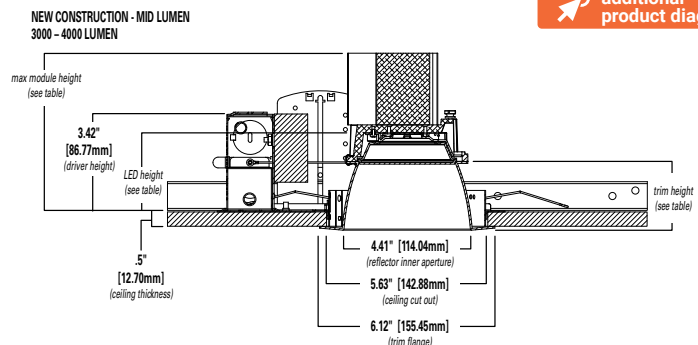
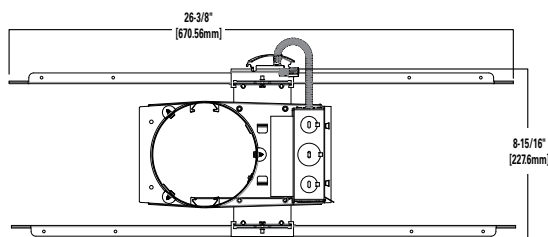

Mid Lumen (3000 – 4000 Lumens)

Distribution	Max. Module Height	Trim Height	LED Height
Narrow	5.6"	2.5"	2.9"
Medium	5.7"	2.6"	3.0"
Wide	5.5"	2.4"	2.8"
Baffle	5.5"	2.4"	2.8"

## Mounting Frame Order Information

Sample Number : HC420D010REM7 - HM40525930 - 41MDC

A complete luminaire consists of a housing frame, LED module, and reflector (ordered separately)

Mounting Frame	Lumens	Driver Options	Factory Installed Emergency & Connected Lighting Options	Accessories (Order & Install Separately)
<p><b>HC4</b> = 4" new construction downlight housing</p> <p><b>HC4CP</b> = 4" new construction housing, Chicago Plenum - CCEA compliant</p>	<p><b>05</b> = 500 lm  <b>07</b> = 750 lm  <b>10</b> = 1000 lm  <b>15</b> = 1500 lm  <b>20</b> = 2000 lm  <b>25</b> = 2500 lm  <b>30</b> = 3000 lm  <b>35</b> = 3500 lm  <b>40</b> = 4000 lm  <b>45</b> = 4500 lm <sup>(7)</sup>  <b>50</b> = 5000 lm <sup>(7)</sup>  <b>55</b> = 5500 lm <sup>(7)</sup>  <b>60</b> = 6000 lm <sup>(7)</sup></p>	<p><b>D010</b>-UNV 120-277V, 50/60Hz, 0-10V 1%-100% dimming at 120-277V on 0-10V controls</p> <p><b>Canada Option 500-4000 lumens:</b>  <b>D010347</b> = 347VAC 50/60Hz 0-10V 1%-100% dimming. For 500, 750, 1000, 1500, 2000, 2500, 3000, 3500, 4000lm models only <sup>(1)</sup></p> <p><b>Canada Option 4500-6000 lumens:</b>  <b>D010X347</b> = step down transformer factory installed (with standard "D010" 120V-277V LED driver). For 4500, 5000, 5500, 6000lm models only <sup>(1)</sup></p> <p><b>DLV</b> = Distributed Low Voltage dimming driver 1%-100%, 1000-4000 lumens only. For use with DLVP system only, refer to DLVP specifications for details. <sup>(1)</sup></p>	<p><b>REM7</b> = 7 watt emergency battery pack with remote test / indicator light, use with D010 only <sup>(1)(2)(6)</sup></p> <p><b>REM14</b> = 14 watt emergency battery pack with remote test / indicator light, use with D010 only <sup>(1)(2)(6)</sup></p> <p><b>IEM7</b> = 7 watt emergency battery pack with integral test / indicator light, use with D010 only <sup>(1)(2)(6)(10)</sup></p> <p><b>IEM14</b> = 14 watt emergency battery pack with integral test / indicator light, use with D010 only <sup>(1)(2)(6)(10)</sup></p> <p><b>BOD7ST</b> = 7.5 watt Bodine self-test emergency battery pack with remote test / indicator light, use with D010 only <sup>(1)(2)(6)</sup></p> <p><b>WTA</b> = Factory WaveLinX PRO Tilemount Sensor Kit <sup>(4)</sup></p> <p><b>WTK</b> = Factory WaveLinX LITE Tilemount Sensor Kit <sup>(5)</sup></p> <p><b>WPN</b> = WaveLinX PRO Wireless Node without Sensor <sup>(11)</sup></p> <p><b>WLN</b> = WaveLinX LITE Wireless Node without Sensor <sup>(12)</sup></p> <p><b>REM7</b> = 7 watt emergency battery pack with remote test / indicator light, use with DLV only <sup>(1)(2)(6)</sup></p> <p><b>REM14</b> = 14 watt emergency battery pack with remote test / indicator light, use with DLV only <sup>(1)(2)(6)</sup></p> <p><b>IEM7</b> = 7 watt emergency battery pack with integral test / indicator light, use with DLV only <sup>(1)(2)(6)(10)</sup></p> <p><b>IEM14</b> = 14 watt emergency battery pack with integral test / indicator light, use with DLV only <sup>(1)(2)(6)(12)</sup></p>	<p><b>HB128APK</b> = L channel hanger bar, 26", pair (replacement)</p> <p><b>RMB22</b> = Adjustable wood joist mounting bars, pair, extend to 22" long</p> <p><b>H347</b> = 347 to 120V step down transformer, 75VA</p> <p><b>H347200</b> = 347 to 120V step down transformer, 200VA</p> <p><b>WTA</b> = Field WaveLinX PRO Tilemount Sensor Kit <sup>(4)</sup></p> <p><b>WTK</b> = Field WaveLinX LITE Tilemount Sensor Kit <sup>(5)</sup></p>
<b>Notes</b>	<b>Notes</b>	<b>Notes</b>	<b>Notes</b>	<b>Notes</b>
	(7) Marked Spacing: Center to Center of Adjacent Luminaires = 36" Center of Luminaire to Building Member = 18" Minimum overhead = 0.5	(1) Not available with CP models	(1) Not available with CP models (2) Not available with D010347 (347V models) (3) ULus for U.S. only (4) WTA = WaveLinX tilemount sensor kit for daylight dimming, PIR motion sensing, and optional RLTS - Real Time Location Services, use with D010 only (Refer to WaveLinX specifications) (5) WTK = WaveLinX LITE tilemount sensor kit for daylight dimming, PIR motion sensing, use with D010 only (Refer to WaveLinX LITE specifications) (6) Emergency battery backup options are Non-IC only, and rated for a minimum starting temperature of 0°C (10) IEM option requires compatible IEM reflector or baffle trim. See Trim Ordering below. (11) WPN = WaveLinX PRO wireless node provides luminaire-level control with scene and zone configuration without an integrated sensor; Connects wirelessly with daylight dimming sensor and PIR motion sensor if desired. Use with 0-10V driver only. Not compatible with 347V or Chicago plenum. (Refer to WaveLinX PRO specifications.) (12) WLN = WaveLinX LITE wireless node provides luminaire-level control with scene and zone configuration without an integrated sensor; Connects wirelessly with daylight dimming sensor and PIR motion sensor if desired. Use with 0-10V driver only. Not compatible with 347V or Chicago plenum. (Refer to WaveLinX LITE specifications.)	(4) WTA = WaveLinX PRO tilemount sensor kit for daylight dimming, PIR motion sensing, and optional RLTS - Real Time Location Services, use with D010 only. (Refer to WaveLinX PRO specifications.) (5) WTK = WaveLinX LITE tilemount sensor kit for daylight dimming, PIR motion sensing, use with D010 only. (Refer to WaveLinX LITE specifications.)

## Quick Spec Emergency Mounting Frame Order Information

Sample Number :

Quick Spec Emergency Mounting Frame: RR-HC420D010REM7

LED module and reflectors are ordered separately.

Order separately: LED Module: HM40525835 | Reflector: 41MDC

Select from the Quick Spec Mounting Frame ordering information to receive the **Fast Delivery** option for the frame.

Quick Spec Code	Mounting Frame	Lumens	Driver Options	Factory Installed Emergency Options	Accessories (Order & Install Separately)
<p><b>RR</b> = East Region  <b>BRR</b> = West Region</p>	<p><b>HC4</b> = 4" new construction downlight housing</p>	<p><b>10</b> = 1000 lm  <b>15</b> = 1500 lm  <b>20</b> = 2000 lm  <b>30</b> = 3000 lm  <b>40</b> = 4000 lm</p>	<p><b>D010</b>-UNV 120-277V, 50/60Hz, 0-10V 1%-100% dimming at 120-277V on 0-10V controls</p>	<p><b>REM7</b> = 7 watt emergency battery pack with remote test / indicator light, use with D010 only <sup>(2)(6)</sup></p> <p><b>REM14</b> = 14 watt emergency battery pack with remote test / indicator light, use with D010 only <sup>(2)(6)</sup></p> <p><b>IEM7</b> = 7 watt emergency battery pack with integral test / indicator light, use with D010 only <sup>(2)(6)(10)</sup></p> <p><b>IEM14</b> = 14 watt emergency battery pack with integral test / indicator light, use with D010 only <sup>(2)(6)(10)</sup></p>	<p><b>HB128APK</b> = L channel hanger bar, 26", pair (replacement)</p> <p><b>RMB22</b> = Adjustable wood joist mounting bars, pair, extend to 22" long</p>
<b>Notes</b>	<b>Notes</b>	<b>Notes</b>	<b>Notes</b>	<b>Notes</b>	<b>Notes</b>
				(2) Not available with D010347 (347V models) (6) Emergency battery backup options are Non-IC only, and rated for a minimum starting temperature of 0°C (10) IEM option requires compatible IEM reflector or baffle trim. See Trim Ordering below.	

## LED Module Order Information

LED Module	Lumens	CRI/CCT	
<b>HM4 = 4" LED module</b>	<b>0525 = 500 - 2500 lumen</b> <b>3040 = 3000-4000 lumen</b> <b>4560 = 4500-6000 lumen</b>	<b>827 = 80CRI, 2700K</b> <b>830 = 80CRI, 3000K</b> <b>835 = 80CRI, 3500K</b> <b>840 = 80CRI, 4000K</b> <b>850 = 80CRI, 5000K</b>	<b>927 = 90CRI, 2700K</b> <b>930 = 90CRI, 3000K</b> <b>935 = 90CRI, 3500K</b> <b>940 = 90CRI, 4000K</b> <b>950 = 90CRI, 5000K</b>
<b>Notes</b>	<b>Notes</b>	<b>Notes</b>	

## Trim Order Information

Reflector	Distribution <sup>(8)</sup>	Finish	Flange	Accessories
<b>41 = 4" conical reflector</b>	<b>ND = narrow 50° beam angle 0.84 SC (nominal)</b> <b>MD = medium 60° beam angle 1.00 SC (nominal)</b> <b>WD = wide 75° beam angle 1.24 SC (nominal)</b> <b>RWW = rotatable wall wash with linear spread lens</b>	<b>C = Specular clear</b> <b>H = Semi-specular clear</b> <b>W = White</b>	<b>Blank = Polished flange standard with C &amp; H reflectors</b> <b>Blank = White flange standard with W reflectors</b> <b>WF = White flange option available with C &amp; H reflectors</b> <b>BF = Black Flange option available with C, H &amp; W reflectors</b>	<b>41RWWPK = Replacement part kit - wall wash lens insert - for use with 41RWW* only.</b>
<b>Notes</b>	<b>Notes</b>	<b>Notes</b>	<b>Notes</b>	<b>Notes</b>
	(8) Values are nominal for white reflector, others may vary.			

Baffle	Distribution <sup>(8)</sup>	Finish	Flange	Accessories
<b>41 = 4" baffle reflector</b>	<b>WD = wide 75° beam angle 1.24 SC (nominal)</b> <b>RWW = rotatable wall wash with linear spread lens</b>	<b>BB = Black baffle</b> <b>WB = White baffle</b>	<b>Blank = White flange standard with BB, &amp; WB reflectors</b> <b>BF = Black flange option available with BB reflectors</b>	<b>41RWWPK = Replacement part kit - wall wash lens insert - for use with 41RWW* only.</b>
<b>Notes</b>	<b>Notes</b>	<b>Notes</b>	<b>Notes</b>	<b>Notes</b>
	(8) Values are nominal for white reflector, others may vary.			

Reflector	Distribution <sup>(8)</sup>	Finish	Flange
<b>41PS = 4" non-conductive polymer 'dead front' conical reflector<sup>(9)</sup></b>	<b>MD = medium 60° beam angle 1.00 SC (nominal)</b>	<b>W = White</b>	<b>Blank = White flange standard with W reflectors</b> <b>BF = Black Flange option available with W reflectors</b>
<b>Notes</b>	<b>Notes</b>	<b>Notes</b>	<b>Notes</b>
(9) 41PS* is 1000-3000 lumens Non-IC rated. 500 & 750 lumens IC rated. 41PS is not for use over 3000 lumens in Non-IC or over 750 lumens in IC.	(8) Values are nominal for white reflector, others may vary.		

IEM Reflector	Distribution <sup>(8)</sup>	Finish	Flange	Integral Emergency
<b>41 = 4" conical reflector for integral emergency only</b>	<b>ND = narrow 50° beam angle 0.84 SC (nominal)</b> <b>MD = medium 60° beam angle 1.00 SC (nominal)</b> <b>WD = wide 75° beam angle 1.24 SC (nominal)</b>	<b>C = Specular clear</b> <b>H = Semi-specular clear</b> <b>W = White</b>	<b>Blank = Polished flange standard with C &amp; H reflectors</b> <b>Blank = White flange standard with W reflectors</b> <b>WF = White flange option available with C &amp; H reflectors</b> <b>BF = Black flange option available with C, H, &amp; W reflectors</b>	<b>IEM = Reflector for use with integral emergency housings only. Provides access hole for integral emergency test switch.</b>
<b>Notes</b>	<b>Notes</b>	<b>Notes</b>	<b>Notes</b>	<b>Notes</b>
	(8) Values are nominal for white reflector, others may vary.			

IEM Baffle	Distribution <sup>(8)</sup>	Finish	Flange	Integral Emergency
<b>41 = 4" baffle reflector for integral emergency only</b>	<b>WD = wide 75° beam angle 1.24 SC (nominal)</b>	<b>BB = Black baffle</b> <b>WB = White baffle</b>	<b>Blank = White flange standard with BB, &amp; WB reflectors</b> <b>BF = Black flange option with BB reflectors</b>	<b>IEM = Reflector for use with integral emergency housings only. Provides access hole for integral emergency test switch.</b>
<b>Notes</b>	<b>Notes</b>	<b>Notes</b>	<b>Notes</b>	<b>Notes</b>
	(8) Values are nominal for white reflector, others may vary.			

## Product Specifications

### Housing Frame

- Boat shaped galvanized steel plaster frame with adjustable plaster lip
- Accommodates 1/2" to 1-1/2" thick ceilings
- Installs in new construction or from below the finished ceiling (non-accessible) for remodeling
- Provided with two remodel clips to secure the frame to the ceiling

### Universal Mounting Bracket

- Adjusts 2" vertically from above and below the ceiling
- Use with the included mounting bars or with 1/2" Electric Metallic Tube (EMT)
- Removable to facilitate remodeling installation from below the finished ceiling

### Mounting Bars

- Captive pre-installed No Fuss™ mounting bars lock to T-grid with screwdriver or pliers
- Centering detents allow for consistent positioning of fixtures

### LED Module

- Proximity phosphors over chip on board LEDs provide a uniform source with high efficiency and no pixilation
- Available in 80 or 90 color rendering index (CRI)
- Color accuracy within 3 SDCM provides color consistency and uniformity
- 90 CRI option: R9>50 (refer to chromaticity information for details)
- Available in 2700K, 3000K, 3500K, 4000K and 5000K correlated color temperature (CCT)
- Lumen options include 500, 750, 1000, 1500, 2000, 2500, 3000, 3500, 4000, 4500, 5000, 5500, 6000 lumens (nominal)
- Passive thermal management achieves 60,000 hours at 70% lumen maintenance (L70) in insulated ceilings (IC) and non-IC applications
- Integral diffuse lens provides visual shielding
- Integral connector allows quick connection to housing flex

### Reflector

- Self-flanged aluminum reflectors available in narrow, medium or wide distribution patterns
- Medium distribution polymer non-conductive matte white reflector may be used to meet local codes for 'dead front' applications (500 & 750 lumen max. in IC and 3000 lumen max. in Non-IC)
- Wall wash reflector features a rotatable linear spread lens for alignment of vertical illumination
- Reflectors attach to LED module with three speed clamps
- Available in multiple painted or plated finishes

### Reflector/Module Retention

- Reflector/module assembly is securely retained in the housing with two torsion springs

### Driver

- Field-replaceable constant current driver provides low noise operation
- Universal 120-277VAC 50/60Hz input standard
- Continuous, 1% to 100% dimming with 0-10V analog control
- Optional low-voltage DC driver for use with Distributed Low Voltage Power (DLVP) system
- Distributed Low Voltage Power (DLVP) system combines power, lighting and controls with ease of installation (refer to DLVP Design Guide at [www.cooperlighting.com](http://www.cooperlighting.com) for details)

### Canada Options

- 347VAC 50/60Hz; 1% dimming on 0-10V analog control, for 500, 750, 1000, 1500, 2000, 2500, 3000, 3500, 4000 lumen models only
- 347V step down transformer factory installed with the standard "D010" 120V-277V, LED driver on 4500, 5000, 5500, 6000 lumen models only

### Emergency Option

- Provides 90 minutes of standby lighting, meeting most life safety codes for egress lighting
- Available with integral or remote charge indicator and test switch
- Available Self-Test (self-diagnostic) with remote charge indicator and test switch
- Quick Spec emergency ordering option for quick-turn projects

### Connected Lighting System

Two WaveLinX connected solutions to choose from. Refer to WaveLinX system specifications and application guides for details.

#### WaveLinX PRO Tilemount Sensor Kit

- WaveLinX PRO WTA tilemount sensor kit offers daylight dimming, PIR motion sensing, scene and zone configuration, automatic commissioning; and optional RLTS - Real Time Location Services available.

#### WaveLinX PRO Wireless Node

- WaveLinX PRO WPN wireless node provides luminaire-level control with scene and zone configuration without an integrated sensor; Connects wirelessly with daylight dimming sensor and PIR motion sensor if desired. Use with 0-10V driver only. **Note:** Not compatible with 347V or Chicago plenum.

#### WaveLinX LITE Tilemount Sensor Kit

- WaveLinX LITE WTK tilemount sensor kit offers daylight dimming and PIR motion sensing, scene and grouping configuration.

#### WaveLinX LITE Wireless Node

- WaveLinX LITE WLN wireless node provides luminaire level control with scene and zone configuration without an integrated sensor; Connects wirelessly with daylight dimming sensor and PIR motion sensor if desired. Use with 0-10V driver only. **Note:** Not compatible with 347V or Chicago plenum.

### WaveLinX Tilemount Sensor Kits Application

- The WTA and WTK tilemount sensor kits include a control module mounted on the luminaire junction box via 1/2" knock-out, and a tilemount sensor on 54-inch whip; for ceiling installation by direct-mount spring clips or via mounting bracket in octagon ceiling boxes.
- The WTA and WTK tilemount sensor kits may be ordered as factory installed on the luminaire, or ordered separately as a field installed accessory kit.
- **Note: WaveLinX PRO devices are only compatible with the WaveLinX PRO system.**
- **Note: WaveLinX LITE devices are only compatible with the WaveLinX LITE system.**

### Junction Box

- Galvanized steel junction box
- 20 in<sup>3</sup> internal volume excluding voltage barrier
- 25 in<sup>3</sup> internal total volume
- Voltage barrier for 0-10V dimming wires (occupies one 1/2" pry-out space)
- Listed for eight #12 AWG (four in, four out) 90°C conductors and feed-thru branch wiring
- Three 1/2" and two 3/4" trade size pry-outs available
- Three 4-port push wire nuts for mains voltage with 1-port for fixture connection

### Compliance

- cULus Certified to UL 1598 / C22.2 No. 250.0, suitable for damp locations and wet locations in covered ceilings only
- Emergency options provided with UL Listed emergency drivers to UL 924 / C22.2 No. 141, suitable for indoor/damp locations
- IP20 - Above finished ceiling; IP64 - Below finished ceiling
- Non-Insulated ceiling (Non-IC) rated for 2000, 2500, 3000, 3500, 4000, 4500, 5000, 5500, 6000 lumen models (insulation must be kept 3" from top and sides)
- Insulated ceiling (IC) rated for 500, 750, 1000, 1500 lumen models and suitable for direct contact with air permeable insulation\* (IC models are also suitable for Non-IC installations)
- Non-IC marked spacing required for 4500, 5000, 5500, 6000 lumen models
  - Marked Spacing Center to Center of Adjacent Luminaires = 36"
  - Center of Luminaire to Building Member = 18"
  - Minimum overhead = 0.5"
- Airtight per ASTM-E283-04
- Suitable for use in clothes closets when installed in accordance with the NEC 410.16 spacing requirements
- EMI/RFI emissions FCC CFR Title 47 Part 15 Class A at 120/277V
- Contains no mercury or lead and RoHS compliant
- Photometric testing completed in accordance of IES LM-79-08
- Lumen maintenance projection in accordance of IES LM-80-08 and TM-21-11
- 1,000 and 1,500 lumen, 90 CRI, ICAT models may be used to comply with State of California Title 24 residential code, per JA8 certification standards
- May be used to comply with State of California Title 24 non-residential code as a dimmable LED luminaire
- ENERGY STAR® certified, reference certified light fixtures database
  - \*Not for use in direct contact with spray foam insulation, consult NEMA LSD57-2013

### Warranty

- Five year limited warranty, consult website for details. [www.cooperlighting.com/legal](http://www.cooperlighting.com/legal)

## Photometric Data

 View IES files

### NARROW DISTRIBUTION - SPECULAR CLEAR FINISH, 2000 LUMEN MODEL, 80 CRI, 3500K

NARROW (50° BEAM*)	
Test Number	P571728
Housing	HC420D010
Module	HM40525835
Reflector	41NDC
Lumens	2010 Lm
Efficacy	100.5 Lm/W
SC	0.84
UGR	12.2

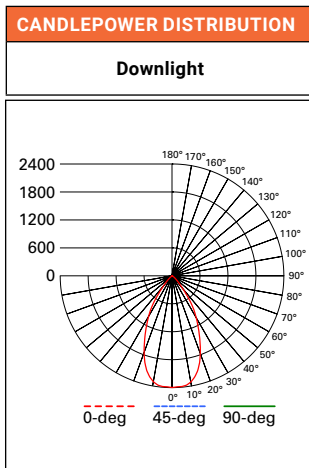

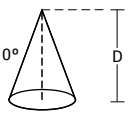
CONE OF LIGHT				
				
MH	FC	L	W	
5.5'	79.3	4.6	4.6	
7'	49	5.8	5.8	
8'	37.5	6.6	6.6	
9'	29.6	7.4	7.4	
10'	24	8.4	8.4	
12'	16.7	10	10	

CANDELA TABLE	
Degrees Vertical	Candela
0	2400
5	2387
15	2110
25	1368
35	676
45	152
55	23
65	5
75	1
85	0
90	0

ZONAL LUMEN SUMMARY		
Zone	Lumens	% Fixture
0-30	1436	71.5
0-40	1848	92
0-60	2002	99.6
0-90	2010	100
90-180	0	0
0-180	2010	100

LUMINANCE	
Average Candela Degrees	Average 0° Luminance
45	26514
55	4968
65	1576
75	667
85	0

\*Value are nominal for specular clear reflectors, other may vary.  
SC = Spacing Criteria  
UGR = Unified Glare Rating

### MEDIUM DISTRIBUTION - SPECULAR CLEAR FINISH, 2000 LUMEN MODEL, 80 CRI, 3500K

MEDIUM (60° BEAM*)	
Test Number	P571727
Housing	HC420D010
Module	HM40525835
Reflector	41MDC
Lumens	2096 Lm
Efficacy	104.8 Lm/W
SC	1.0
UGR	13.6

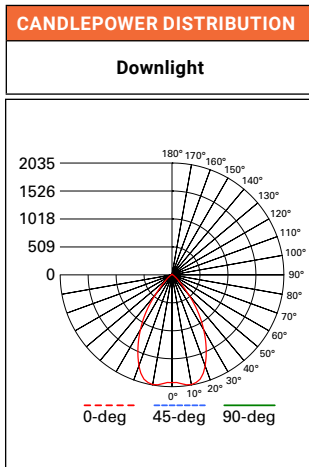

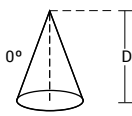
CONE OF LIGHT				
				
MH	FC	L	W	
5.5'	65.3	5.4	5.4	
7'	40.3	6.8	6.8	
8'	30.9	7.8	7.8	
9'	24.4	8.8	8.8	
10'	19.8	9.8	9.8	
12'	13.7	11.8	11.8	

CANDELA TABLE	
Degrees Vertical	Candela
0	1969
5	1997
15	1974
25	1467
35	800
45	192
55	26
65	4
75	1
85	0
90	0

ZONAL LUMEN SUMMARY		
Zone	Lumens	% Fixture
0-30	1408	67.1
0-40	1899	90.6
0-60	2091	99.7
0-90	2096	100
90-180	0	0
0-180	2096	100

LUMINANCE	
Average Candela Degrees	Average 0° Luminance
45	33405
55	5548
65	1197
75	667
85	0

\*Value are nominal for specular clear reflectors, other may vary.  
SC = Spacing Criteria  
UGR = Unified Glare Rating

## WIDE DISTRIBUTION - SPECULAR CLEAR FINISH, 2000 LUMEN MODEL, 80 CRI, 3500K

WIDE (75° BEAM*)	
Test Number	P571730
Housing	HC420D010
Module	HM40525835
Reflector	41WDC
Lumens	2304 Lm
Efficacy	115.2 Lm/W
SC	1.25
UGR	15.7

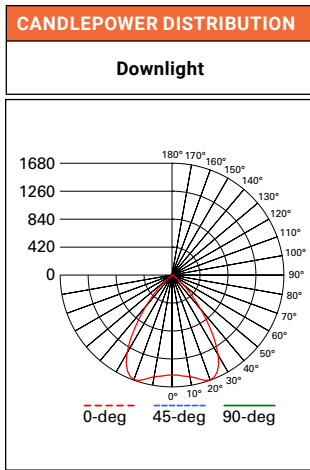

CONE OF LIGHT			
MH	FC	L	W
5.5'	49.9	6.8	6.8
7'	30.8	8.6	8.6
8'	23.6	9.8	9.8
9'	18.6	11.2	11.2
10'	15.1	12.4	12.4
12'	10.5	14.8	14.8

CANDELA TABLE	
Degrees Vertical	Candela
0	1509
5	1525
15	1630
25	1603
35	1012
45	369
55	44
65	5
75	1
85	0
90	0

ZONAL LUMEN SUMMARY		
Zone	Lumens	% Fixture
0-30	1334	57.9
0-40	1960	85.1
0-60	2296	99.7
0-90	2304	100
90-180	0	0
0-180	2304	100

LUMINANCE	
Average Candela Degrees	Average 0° Luminance
45	64437
55	9355
65	1576
75	667
85	0

\*Value are nominal for specular clear reflectors, other may vary.  
 SC = Spacing Criteria  
 UGR = Unified Glare Rating

### Photometric Multipliers (Nominal Lumen Values)

500 Lumen	750 Lumen	1000 Lumen	1500 Lumen	2000 Lumen	2500 Lumen	3000 Lumen	3500 Lumen
0.33	0.44	0.54	0.74	1.00	1.24	1.54	1.85

4000 Lumen	4500 Lumen	5000 Lumen	5500 Lumen	6000 Lumen
2.15	2.28	2.44	2.52	2.62

Multipliers for relative lumen values with other series models.

### Color Finish Multipliers

Finish code	C	H	W/WB	BB
Finish	Specular Clear	Semi-Specular	Matte White White Baffle	Black Baffle
Multiplier	1.00	0.94	0.88	0.76

Multipliers for relative lumen values with other color finishes.

### CCT Multipliers – 80CRI

2700K	3000K	3500K	4000K	5000K
0.89	0.96	1.00	1.03	1.03

Multipliers for relative lumen values with other series color temperatures.

### CCT Multipliers – 90CRI

2700K	3000K	3500K	4000K	5000K
0.76	0.85	0.89	0.93	0.93

Multipliers for relative lumen values with other series color temperatures.

## WALL WASH DISTRIBUTION - SPECULAR CLEAR FINISH, 2000 LUMEN MODEL, 80 CRI, 3500K

WALL WASH	
Test Number	P571729
Housing	HC420D010
Module	HM40525835
Reflector	41RWWC
Lumens	2094 Lm
Efficacy	104.7 Lm/W
SC	1.15

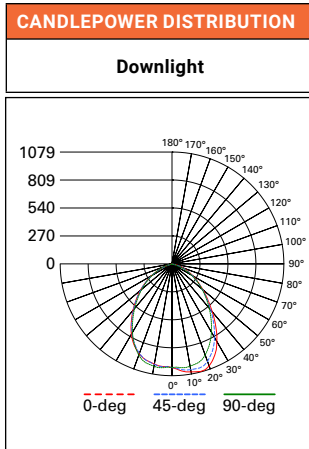

CANDELA TABLE	
Degrees Vertical	Candela
0	1005
5	1041
15	1079
25	980
35	743
45	494
55	312
65	180
75	80
85	10
90	0

ZONAL LUMEN SUMMARY		
Zone	Lumens	% Fixture
0-30	789	37.7
0-40	1221	58.3
0-60	1872	89.4
0-90	2094	100
90-180	0	0
0-180	2094	100

LUMINANCE	
Average Candela Degrees	Average 0° Luminance
45	86207
55	67159
65	52681
75	38173
85	13445

SC = Spacing Criteria, nominal for specular clear reflector, other may vary.

SINGLE UNIT FOOTCANDLES							
2.5' from wall (distance from fixture along wall)							
1	18.7	13.6	6.1	2.3	0.8	0.3	0.1
2	28.4	22.3	12.2	5.7	2.6	1.2	0.6
3	25.9	21.4	13.3	7.2	3.8	2	1.1
4	19.6	16.9	11.6	7	4.1	2.4	1.4
5	13.6	12.3	9.2	6.2	3.9	2.5	1.5
6	9.3	8.6	7	5.1	3.5	2.3	1.6
7	6.4	6.1	5.2	4.1	3	2.1	1.5
8	4.6	4.4	3.9	3.2	2.5	1.8	1.3
9	3.3	3.2	2.9	2.5	2	1.6	1.2
10	2.5	2.4	2.2	2	1.7	1.4	1.1

MULTIPLE UNIT FOOTCANDLES								
2.5' from wall (Distance from fixture along wall)				2.5' from wall (Distance from fixture along wall)				
1	21	18.8	21	19.5	12.1	19.5		
2	34.1	34.1	34.1	31	24.4	31		
3	33.1	34.4	33.1	29.7	26.5	29.7		
4	26.7	28.7	26.7	23.7	23.3	23.7		
5	19.8	21.7	19.8	17.5	18.5	17.5		
6	14.4	15.8	14.4	12.8	14	12.8		
7	10.5	11.4	10.5	9.4	10.4	9.4		
8	7.8	8.3	7.8	7	7.7	7		
9	5.8	6.2	5.8	5.4	5.9	5.4		
10	4.4	4.7	4.4	4.1	4.5	4.1		

### Photometric Multipliers (Nominal Lumen Values)

500 Lumen	750 Lumen	1000 Lumen	1500 Lumen	2000 Lumen	2500 Lumen	3000 Lumen	3500 Lumen
0.33	0.44	0.54	0.74	1.00	1.24	1.54	1.85

4000 Lumen	4500 Lumen	5000 Lumen	5500 Lumen	6000 Lumen
2.15	2.28	2.44	2.52	2.62

Multipliers for relative lumen values with other series models.

### Color Finish Multipliers

Finish code	C	H	W/WB	BB
Finish	Specular Clear	Semi-Specular	Matte White White Baffle	Black Baffle
Multiplier	1.00	0.94	0.88	0.76

Multipliers for relative lumen values with other color finishes.

### CCT Multipliers - 80CRI

2700K	3000K	3500K	4000K	5000K
0.89	0.96	1.00	1.03	1.03

Multipliers for relative lumen values with other series color temperatures.

### CCT Multipliers - 90CRI

2700K	3000K	3500K	4000K	5000K
0.76	0.85	0.89	0.93	0.93

Multipliers for relative lumen values with other series color temperatures.

## Energy & Performance Data

### COLOR METRICS - TM-30-15 & CRI/CIE (3500K)

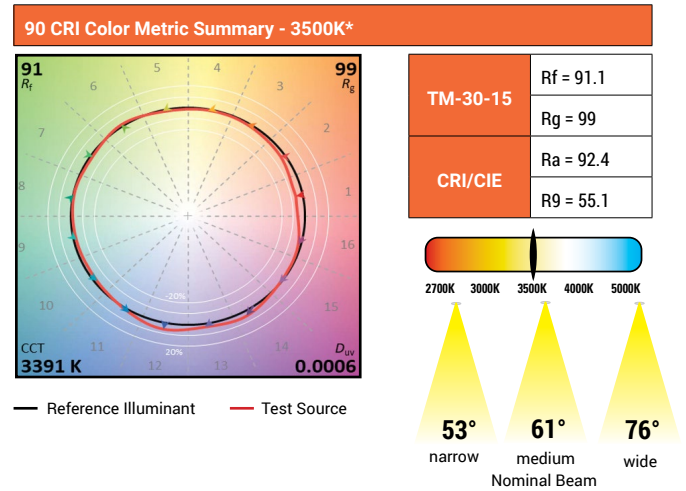
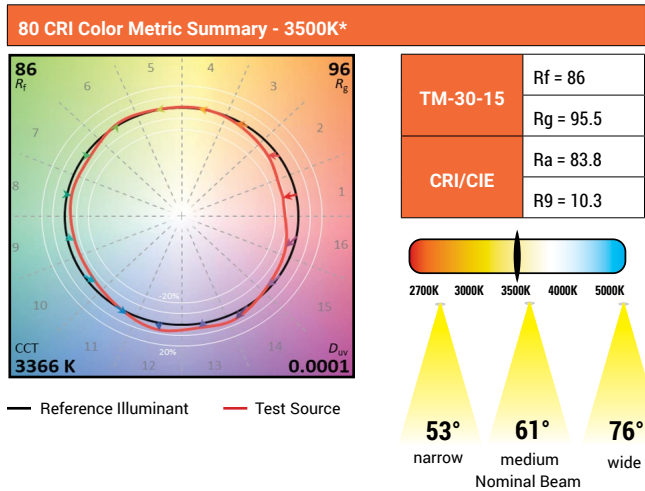

\* Color values are based on 61WDWB reflector, other finishes and field results may vary.

### ENERGY DATA

Series	500 lumen		750 lumen		1000 lumen		1500 lumen		2000 lumen	
	120V	277V	120V	277V	120V	277V	120V	277V	120V	277V
Input Voltage 120-277VAC	120V	277V	120V	277V	120V	277V	120V	277V	120V	277V
Input Current (A)	0.051	0.026	0.067	0.036	0.083	0.039	0.119	0.053	0.171	0.077
Input Power (W)	6.1	6.5	7.9	8.3	10	10.4	14.5	14.5	20.9	20.6
In-rush (A)	1.9	8.4	2	8.4	2.2	8.5	2.7	8.5	2.1	9.7
Inrush duration (µs)	251	135	237	133	250	134	250	139	245	131
THD (%)	6.2	13.5	7.4	8.8	5.4	10.3	10	6.7	6.5	7.9
PF	≥ 0.99	≥ 0.9	≥ 0.98	≥ 0.92	≥ 0.99	≥ 0.95	≥ 0.99	≥ 0.97	≥ 0.99	≥ 0.96

Series	2500 lumen		3000 lumen		3500 lumen		4000 lumen		4500 lumen	
	120V	277V	120V	277V	120V	277V	120V	277V	120V	277V
Input Voltage 120-277VAC	120V	277V	120V	277V	120V	277V	120V	277V	120V	277V
Input Current (A)	0.23	0.103	0.24	0.107	0.292	0.152	0.351	0.159	0.384	0.172
Input Power (W)	27.5	27.5	28.6	28.5	34.6	35.1	42.1	42.1	45.9	45.6
In-rush (A)	2.5	5.6	2.5	11.6	3.4	13.9	3.1	14.7	3.1	14.8
Inrush duration (µs)	232	123	216	111	183	95	200	98	202	100
THD (%)	6.5	8.1	7.8	8.3	5.6	10	4.1	9.5	4.5	8.5
PF	≥ 0.99	≥ 0.96	≥ 0.99	≥ 0.96	≥ 0.99	≥ 0.93	≥ 0.99	≥ 0.94	≥ 0.99	≥ 0.95

Series	5000 lumen		5500 lumen		6000 lumen	
	120V	277V	120V	277V	120V	277V
Input Voltage 120-277VAC	120V	277V	120V	277V	120V	277V
Input Current (A)	0.419	0.186	0.457	0.201	0.489	0.214
Input Power (W)	50.1	49.5	54.6	53.7	58.4	57.4
In-rush (A)	3.1	15	3.2	14.8	3.4	14.8
Inrush duration (µs)	202	117	196	131	192	121
THD (%)	5.5	7.6	7	7.2	8.1	7.2
PF	≥ 0.99	≥ 0.96	≥ 0.99	≥ 0.96	≥ 0.99	≥ 0.97

Minimum starting temperature -30°C (-22°F)\*  
(Nominal input 120-277VAC & 100% of rated output power)

Sound Rating: Class A standards

#### Notes:

\* Emergency Battery packs are rated for a minimum starting temperature of 0°C.



## Dimensional and Mounting Details

### NEW CONSTRUCTIONS - LOW LUMEN 500 – 2500 LUMENS

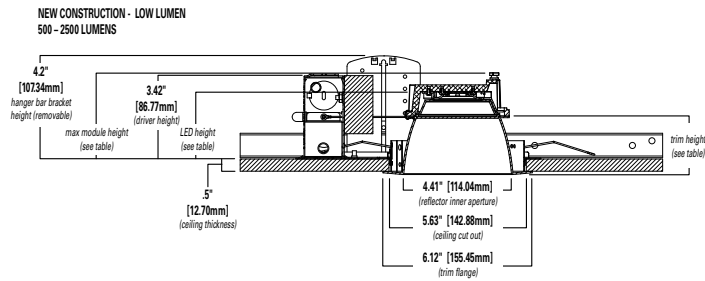

#### Low Lumen (500 – 2500 Lumens)\*

Distribution	Max. Module Height	Trim Height	LED Height
Narrow	3.6"	2.5"	2.7"
Medium	3.7"	2.6"	2.8"
Wide	3.5"	2.4"	2.6"
Baffle	3.1"	2.4"	2.6"



Low Lumen Module

\*Max. height w/removable hanger bar bracket 4.2"

### NEW CONSTRUCTIONS - MID LUMEN 3000 – 4000 LUMENS

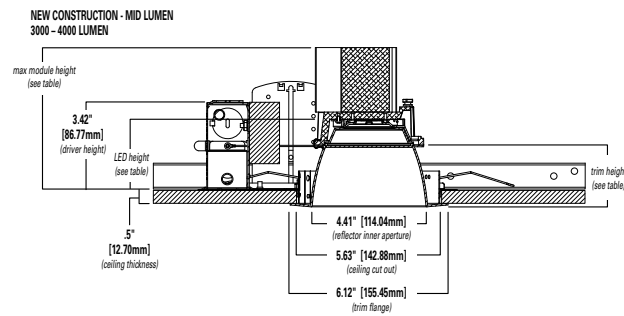

#### Mid Lumen (3000 – 4000 Lumens)

Distribution	Max. Module Height	Trim Height	LED Height
Narrow	5.6"	2.5"	2.9"
Medium	5.7"	2.6"	3.0"
Wide	5.5"	2.4"	2.8"
Baffle	5.5"	2.4"	2.8"



Mid Lumen Module

### NEW CONSTRUCTIONS - HIGH LUMEN 4500 – 6000 LUMENS

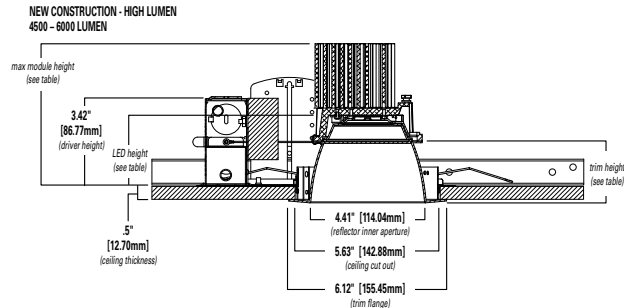

#### High Lumen (4500 – 6000 Lumens)

Distribution	Max. Module Height	Trim Height	LED Height
Narrow	5.9"	2.5"	2.9"
Medium	6.0"	2.6"	3.0"
Wide	5.8"	2.4"	2.8"
Baffle	5.8"	2.4"	2.8"



High Lumen Module

## Connected Solutions

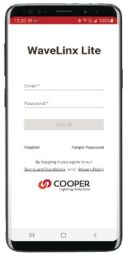

### WaveLinX LITE - WTK Tilemount Sensor

WaveLinX LITE devices only compatible with the WaveLinX LITE system.

- Intuitive Android™ or Apple® iOS® app for basic system code compliant set up and configuration via Bluetooth
- Up to 28 unique areas per project site (WaveLinX LITE Bluetooth network)
- Up to 50 devices for an area, any one of 16 control zones, up to 6 occupancy sets, and custom lighting scenes
- Automatic occupancy or vacancy, sensor sensitivity, daylight dimming, etc. configurable through the app
- Refer to the WaveLinX system specifications for details



#### WaveLinX LITE WTK Tilemount Wiring Diagram

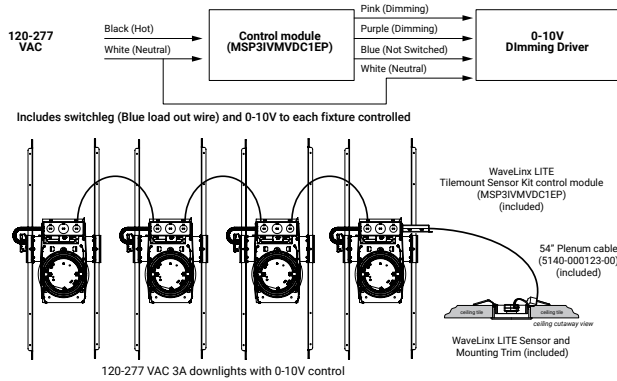

#### WaveLinX LITE Bluetooth Enabled System



### WaveLinX PRO – WTA Tilemount Sensor

WaveLinX PRO devices only compatible with the WaveLinX PRO system.

- WaveLinX PRO tilemount functionality configures zones and customizes settings from one secure mobile app
- Automatic code commissioning that meets the strictest codes
- Fixtures and sensors integrate with Wireless Area Controller, Wall Stations, and Control Devices
- Stand-Alone Offices or Entire Building Network Installations

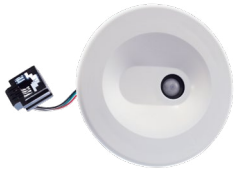

**Downlights with tilemount sensor**  
Highly efficient LED fixtures

**WaveLinX Area Controller**  
Provides centralized coordination of multiple area control options

**Wireless Wall Station/Receptacle**  
Provides customized wireless control of each area

**Mobile Applications**  
Provides personalized, local control from a tablet or smartphone

#### WaveLinX mobile app settings

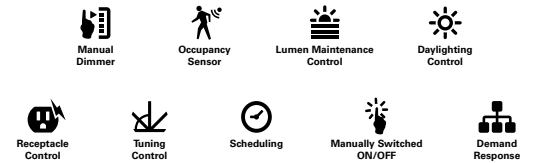

#### WaveLinX WTA Tilemount Wiring Diagram

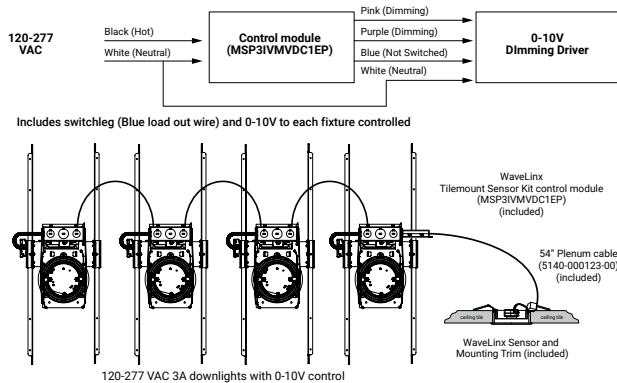

#### WaveLinX CORE Building Management Integration

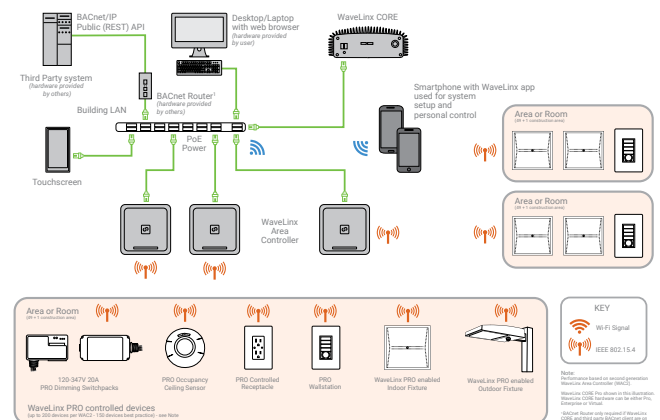

## Connected Solutions



### WaveLinX LITE Wireless Node - WLN

WaveLinX LITE devices only compatible with the WaveLinX LITE system.

- Intuitive Android™ or Apple® iOS® app for basic system code compliant set up and configuration via Bluetooth
- Up to 28 unique areas per project site (WaveLinX LITE Bluetooth network)
- Up to 50 devices for an area, any one of 16 control zones, up to 6 occupancy sets, and custom lighting scenes
- Refer to the WaveLinX system specifications for details

#### WaveLinX mobile app settings



#### WaveLinX LITE Wireless Node (WLN) Wiring Diagram

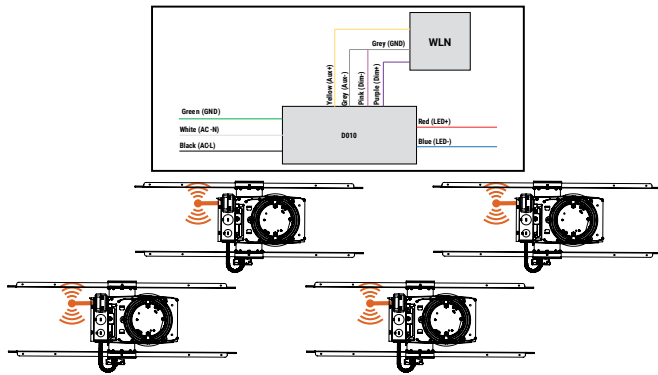

#### WaveLinX LITE Bluetooth Enabled System



### WaveLinX PRO Wireless Node - WPN

WaveLinX PRO devices only compatible with the WaveLinX PRO system.



- WaveLinX Wireless functionality configures zones and customizes settings from one secure mobile app
- Automatic code commissioning that meets the strictest codes
- Fixtures and sensors integrate with WaveLinX Area Controller, Wall Stations, and Control Devices
- Stand-Alone Offices or Entire Building Network Installations

#### WaveLinX mobile app settings

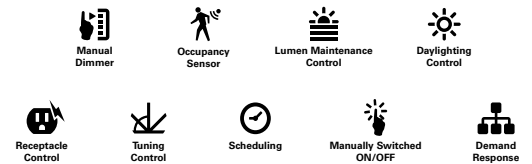

#### WaveLinX PRO Wireless Node (WPN) Wiring Diagram

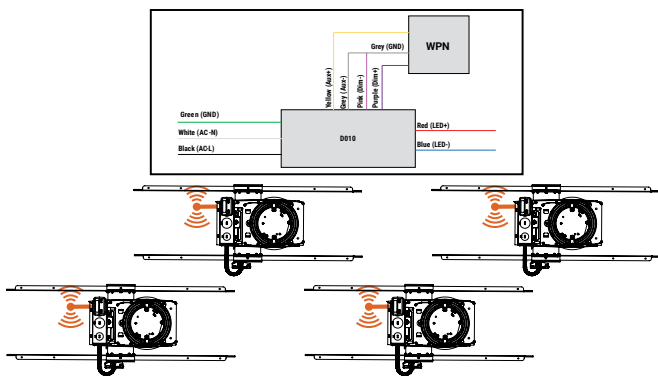

#### WaveLinX CORE Building Management Integration

