

Project		Catalog #		Type	
Prepared by		Notes		Date	



HALO Commercial

HCC4 | HM4 | 41

4-inch lens cylinder and lens wall wash

Typical Applications

Office • Healthcare • Hospitality • Institutional

Interactive Menu

- Order Information [page 2](#)
- Product Specifications [page 3](#)
- Photometric Data [page 4](#)
- Energy & Performance Data [page 7](#)
- Product Warranty

Product Certification



Product Features



Control Compatibility



Top Product Features

- 500 to 4000 lumens
- 2700K, 3000K, 3500K, 4000K, 5000K CCT; 80 or 90 CRI
- Narrow, Medium, Wide beam distribution in precision formed reflectors
- Wall wash with exclusive rotatable linear spread lens
- Specular, Semi Specular, White, Black & White Baffle reflector finishes
- Matte white, matte black, silver and bronze silver cylinder finishes
- Wall mount, and Surface mount with aircraft cable and pendant accessory options

Dimensional and Mounting Details

WALL MOUNT

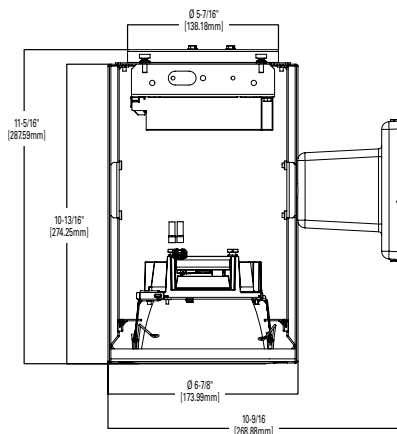

SURFACE MOUNT

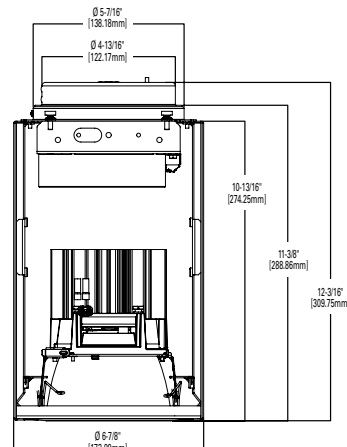

PENDANT

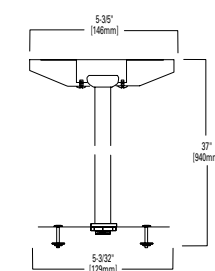

AIRCRAFT CABLE

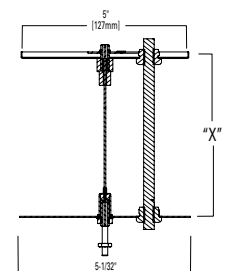

Low Lumen Module



Mid Lumen Module

Order Information

SAMPLE ORDER NUMBER: **HCC4S20D010MW - HM40525930 - 41MDC**

A complete luminaire consists of a cylinder, LED module, and reflector; ordered separately

Cylinder	Lumens	Driver Options	Finish	Factory Installed Connected Lighting Options
HCC4S = 4" Surface Mount Cylinder for ceiling, cable, or pendant mounting HCC4W = 4" Wall Mount Cylinder	05 = 500 lm 07 = 750 lm 10 = 1000 lm 15 = 1500 lm 20 = 2000 lm 25 = 2500 lm 30 = 3000 lm 35 = 3500 lm 40 = 4000 lm	D010 = UNV 120-277V, 50/60Hz, 0-10V 1%-100% dimming at 120-277V on 0-10V controls Canada Option 500-4000 lumen D010347 = 347VAC 50/60Hz 0-10V 1%- 100% dimming. For 500, 750, 1000, 1500, 2000, 2500, 3000, 3500, 4000lm models only	MW = Matte White MB = Matte Black BZ = Bronze SL = Silver	WPN = WaveLinx PRO Wireless Node without sensor ⁽⁴⁾ WLN = WaveLinx LITE Wireless Node without Sensor ⁽⁵⁾
Notes	Notes	Notes	Notes	Notes (4) WPN = WaveLinx PRO wireless node provides luminaire-level control with scene and zone configuration without an integrated sensor; Connects wirelessly with daylight dimming sensor and PIR motion sensor if desired. Use with 0-10V driver only. Not compatible with 347V or Chicago plenum. (Refer to WaveLinx PRO system specifications.) (5) WLN = WaveLinx LITE wireless node provides luminaire-level control with scene and zone configuration without an integrated sensor; Connects wirelessly with daylight dimming sensor and PIR motion sensor if desired. Use with 0-10V driver only. Not compatible with 347V or Chicago plenum. (Refer to WaveLinx LITE system specifications.)

Accessories (Order & Install Separately)	Option
Pendant Kit ⁽¹⁾ HCC8P36MW = Matte White pendant stem kit HCC8P36MB = Matte black pendant stem kit HCC8P36BZ = Bronze pendant stem kit HCC8P36SL = Silver pendant stem kit	Blank = 36" SP* = * specify 6 to 144 in 1" increments
Aircraft Cable Kit ^{(1) (2)} HCAC120MW = 120" white power cable & aircraft cable kit HCAC48MW = 48" white power cable & aircraft cable kit HCAC120MB = 120" black power cable & aircraft cable kit HCAC48MB = 48" black power cable & aircraft cable kit	Blank = 5 conductor cable (power & 0-10V dimming)
Notes (1) Pendant and Aircraft Cable mounting accessories for use with surface cylinders. (2) Aircraft cable kit finish options: white or black cable & canopy plate, and stainless steel aircraft cable.	Notes

LED Module	Lumens	CRI / CCT	
HM4 = 4" LED module	0525 = 500 - 2500 lumen 3040 = 3000-4000 lumen	827 = 80CRI, 2700K 830 = 80CRI, 3000K 835 = 80CRI, 3500K 840 = 80CRI, 4000K 850 = 80CRI, 5000K	927 = 90CRI, 2700K 930 = 90CRI, 3000K 935 = 90CRI, 3500K 940 = 90CRI, 4000K 950 = 90CRI, 5000K
Notes	Notes	Notes	

Reflector	Distribution ⁽³⁾	Finish	Flange	Accessories
41 = 4" self-flanged, conical reflector	ND = narrow reflector 53° beam angle, 0.84 SC MD = medium reflector 61° beam angle, 1.00 SC WD = wide reflector 76° beam angle, 1.24 SC RWW = rotatable wall wash with linear spread lens	C = Specular clear H = Semi-specular clear W = White	Blank = Polished flange standard with C & H reflectors Blank = White flange standard with W reflector WF = White flange option available with C & H reflectors BF = Black Flange option available with C, H & W reflectors	41RWWPK = Replacement part kit - wall wash lens insert - for use with 41RWW* only.
41 = 4" self-flanged, baffle reflector	WD = wide baffle 76° beam angle, 1.24 SC RWW = rotatable wall wash with linear spread lens (wide beam baffle with lens wall wash insert)	BB = Black baffle WB = White baffle	Blank = White flange standard with BB & WB reflectors BF = Black flange option available with BB reflectors	
Notes	Notes (3) Values are nominal, based on specular clear reflector, other may vary. Additional factors include CRI/CCT, reflector finish, and lumen selected.	Notes	Notes	

Product Specifications

Cylinder

- Round seamless spun aluminum housing available in matte white, matte black, bronze, or silver paint finish

Mounting

- Ceiling mount: Included cylinder mounting plate installs to ceiling junction box (supplied by others), and the surface cylinder mounts to the plate with easy twist and lock hooks
- Pendant mount: Pendant stem (ordered separately) is field installed to the surface cylinder mounting plate. Offered in matching housing finishes
- Aircraft cable mount: Aircraft cable (ordered separately) is field installed to the surface cylinder mounting plate. Offered in white or black cable kit
- Wall mount: A mounting arm on the cylinder is designed to be attached directly to wall junction box (supplied by others) via a sturdy mounting plate

LED Module

- Proximity phosphors over chip on board LEDs provide a uniform source with high efficiency and no pixilation
- Available in 80 or 90 CRI (nominal), provides accuracy within 3 SDCM color uniformity
- 90 CRI, R9>50 (refer to chromaticity technical note online for details)
- Correlated Color Temperature options (nominal)
 - 2700K, 3000K, 3500K, 4000K, 5000K
- Passive thermal management achieves L70 at 50,000 hours in IC and non IC applications
- Integral diffuse lens provides visual shielding

Lumen Options

- Lumen options include 500, 750, 1000, 1500, 2000, 2500, 3000, 3500, 4000 lumens

Reflector

- Self-flanged aluminum reflectors are available in narrow, medium or wide distribution patterns
- Wall wash reflector features a rotatable linear spread lens for precise alignment of vertical illumination.
- Reflector attaches to LED module with (3) speed clamps
- Multiple painted or plated finishes are available

Reflector / Module Retention

- Reflector / module assembly is securely retained in the housing with (2) torsion springs

Driver

- Field replaceable constant current driver
- UNV 120-277V input standard; continuous dimming 1%-100% with 0-10V analog controls.

Canada option

- 347VAC 50/60Hz; 1% dimming on 0 -10V analog control, for 500, 750, 1000, 1500, 2000, 2500, 3000, 3500, 4000 lumen models only

Electrical Connections

- Quick disconnect allows for tool-less replacement of LED engine from below
- (3) 4-port push wire nuts for mains voltage, with 1-port for fixture connection

Connected Lighting System

Refer to WaveLinx system specifications and application guides for details.

[WaveLinx PRO Wireless Node](#)

- WaveLinx PRO WPN wireless node provides luminaire-level control with scene and zone configuration without an integrated sensor; Connects wirelessly with daylight dimming sensor and PIR motion sensor if desired. Use with 0-10V driver only. **Note:** Not compatible with 347V or Chicago plenum.

[WaveLinx LITE Wireless Node](#)

- WaveLinx LITE WLN wireless node provides luminaire level control with scene and zone configuration without an integrated sensor; Connects wirelessly with daylight dimming sensor and PIR motion sensor if desired. Use with 0-10V driver only. **Note:** Not compatible with 347V or Chicago plenum.
- Note: WaveLinx PRO devices are only compatible with the WaveLinx PRO system.**
- Note: WaveLinx LITE devices are only compatible with the WaveLinx LITE system.**

Compliance

- cULus Certified to UL 1598 / Canada C22.2 No. 250.0
- Surface mount:** suitable for damp and wet locations in covered ceilings only
- Pendant and aircraft cable mount:** suitable for damp locations in covered ceilings only
- Wall mount:** suitable for damp and wet locations
- Note:** Wet location models are IP65 rated (wet location and IP65 not applicable with wall wash reflector which is damp location)
- EMI/RFI emissions FCC CFR Title 47 Part 15 Class A 277V & Class B 120V
- Contains no mercury or lead and RoHS compliant
- Photometric testing in accordance with IES LM-79-08
- Lumen maintenance projections in accordance with IES LM-80-08 and TM-21-11
- May be used to comply with State of California Title 24 non-residential code, as a dimmable LED luminaire
- ENERGY STAR® certified, refer to certified light fixture database

Warranty

- Five year limited warranty, consult website for details. www.cooperlighting.com/legal

Photometric Data

 View IES files

NARROW DISTRIBUTION - SPECULAR CLEAR FINISH, 2000 LUMEN MODEL, 80 CRI, 3500K

NARROW (50° BEAM*)	
Test Number	P571728
Housing	HC420D010 ⁽¹⁾
Module	HM40525835
Reflector	41NDC
Lumens	2010 Lm
Efficacy	100.5 Lm/W
SC	0.84
UGR	12.2

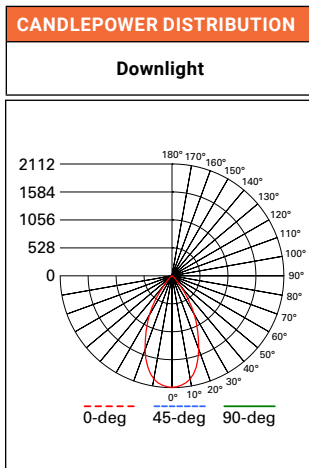

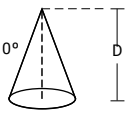
CONE OF LIGHT			
			
MH	FC	L	W
5.5'	79.3	4.6	4.6
7'	49	5.8	5.8
8'	37.5	6.6	6.6
9'	29.6	7.4	7.4
10'	24	8.4	8.4
12'	16.7	10	10

CANDELA TABLE	
Degrees Vertical	Candela
0	2400
5	2387
15	2110
25	1368
35	676
45	152
55	23
65	5
75	1
85	0
90	0

ZONAL LUMEN SUMMARY		
Zone	Lumens	% Fixture
0-30	1436	71.5
0-40	1848	92
0-60	2002	99.6
0-90	2010	100
90-180	0	0
0-180	2010	100

LUMINANCE	
Average Candela Degrees	Average 0° Luminance
45	26514
55	4968
65	1576
75	667
85	0

*Value are nominal with specular clear reflectors, other finishes and field results may vary.
SC = Spacing Criteria
UGR = Unified Glare Rating

1. Test with HC420D010 also applies to HCC420D010 using same reflector and LED module.

MEDIUM DISTRIBUTION - SPECULAR CLEAR FINISH, 2000 LUMEN MODEL, 80 CRI, 3500K

MEDIUM (60° BEAM*)	
Test Number	P571727
Housing	HC420D010 ⁽¹⁾
Module	HM40525835
Reflector	41MDC
Lumens	2096 Lm
Efficacy	104.8 Lm/W
SC	1.0
UGR	13.6

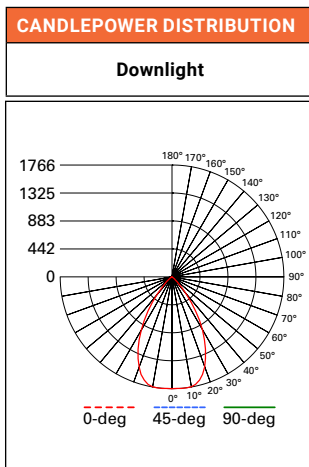

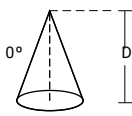
CONE OF LIGHT			
			
MH	FC	L	W
5.5'	65.3	5.4	5.4
7'	40.3	6.8	6.8
8'	30.9	7.8	7.8
9'	24.4	8.8	8.8
10'	19.8	9.8	9.8
12'	13.7	11.8	11.8

CANDELA TABLE	
Degrees Vertical	Candela
0	1969
5	1997
15	1974
25	1467
35	800
45	192
55	26
65	4
75	1
85	0
90	0

ZONAL LUMEN SUMMARY		
Zone	Lumens	% Fixture
0-30	1408	67.1
0-40	1899	90.6
0-60	2091	99.7
0-90	2096	100
90-180	0	0
0-180	2096	100

LUMINANCE	
Average Candela Degrees	Average 0° Luminance
45	33405
55	5548
65	1197
75	667
85	0

*Value are nominal with specular clear reflectors, other finishes and field results may vary.
SC = Spacing Criteria
UGR = Unified Glare Rating

1. Test with HC420D010 also applies to HCC420D010 using same reflector and LED module.

Note: Refer to IES files for more product data.

Photometric Data

View IES files

WIDE DISTRIBUTION - SPECULAR CLEAR FINISH, 2000 LUMEN MODEL, 80 CRI, 3500K

WIDE (75° BEAM*)	
Test Number	P571730
Housing	HC420D010 ⁽¹⁾
Module	HM40525835
Reflector	41WDC
Lumens	2304 Lm
Efficacy	115.2 Lm/W
SC	1.25
UGR	15.7

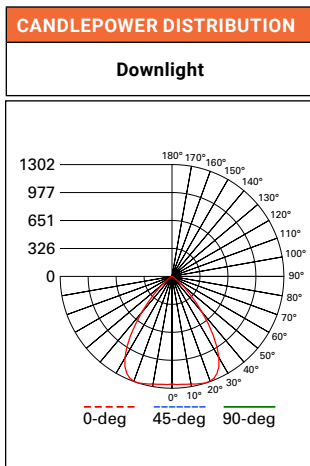

CONE OF LIGHT			
MH	FC	L	W
5.5'	49.9	6.8	6.8
7'	30.8	8.6	8.6
8'	23.6	9.8	9.8
9'	18.6	11.2	11.2
10'	15.1	12.4	12.4
12'	10.5	14.8	14.8

CANDELA TABLE	
Degrees Vertical	Candela
0	1509
5	1525
15	1630
25	1603
35	1012
45	369
55	44
65	5
75	1
85	0
90	0

ZONAL LUMEN SUMMARY		
Zone	Lumens	% Fixture
0-30	1334	57.9
0-40	1960	85.1
0-60	2296	99.7
0-90	2304	100
90-180	0	0
0-180	2304	100

LUMINANCE	
Average Candela Degrees	Average 0° Luminance
45	64437
55	9355
65	1576
75	667
85	0

*Value are nominal with specular clear reflectors, other finishes and field results may vary.
 SC = Spacing Criteria
 UGR = Unified Glare Rating

1. Test with HC420D010 also applies to HCC420D010 using same reflector and LED module.

Photometric Multipliers (Nominal Lumen Values)

500 Lumen	750 Lumen	1000 Lumen	1500 Lumen	2000 Lumen	2500 Lumen	3000 Lumen	3500 Lumen	4000 Lumen
0.33	0.44	0.54	0.74	1.00	1.24	1.54	1.85	2.15

Multipliers for relative lumen values with other series models.

Color Finish Multipliers

Finish code	C	H	W/WB	BB
Finish	Specular Clear	Semi-Specular	Matte White White Baffle	Black Baffle
Multiplier	1.00	0.94	0.88	0.76

Multipliers for relative lumen values with other color finishes.

CCT Multipliers - 80CRI

2700K	3000K	3500K	4000K	5000K
0.89	0.96	1.00	1.03	1.03

Multipliers for relative lumen values with other series color temperatures.

CCT Multipliers - 90CRI

2700K	3000K	3500K	4000K	5000K
0.76	0.85	0.89	0.93	0.93

Multipliers for relative lumen values with other series color temperatures.

Note: Refer to IES files for more product data.

Photometric Data

 View IES files

WALL WASH DISTRIBUTION - SPECULAR CLEAR FINISH, 2000 LUMEN MODEL, 80 CRI, 3500K

WALL WASH	
Test Number	P571729
Housing	HC420D010 ⁽¹⁾
Module	HM40525835
Reflector	41RWWC
Lumens	2094 Lm
Efficacy	104.7 Lm/W
SC	1.15

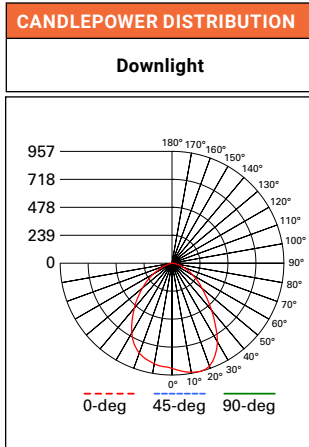

CANDELA TABLE	
Degrees Vertical	Candela
0	1005
5	1041
15	1079
25	980
35	743
45	494
55	312
65	180
75	80
85	10
90	0

ZONAL LUMEN SUMMARY		
Zone	Lumens	% Fixture
0-30	789	37.7
0-40	1221	58.3
0-60	1872	89.4
0-90	2094	100
90-180	0	0
0-180	2094	100

LUMINANCE	
Average Candela Degrees	Average 0° Luminance
45	86207
55	67159
65	52681
75	38173
85	13445

SC = Spacing Criteria, nominal for specular clear reflector, other finishes and field results may vary.

1. Test with HC420D010 also applies to HCC420D010 using same reflector and LED module.

SINGLE UNIT FOOTCANDLES							
2.5' from wall (distance from fixture along wall)							
1	18.7	13.6	6.1	2.3	0.8	0.3	0.1
2	28.4	22.3	12.2	5.7	2.6	1.2	0.6
3	25.9	21.4	13.3	7.2	3.8	2	1.1
4	19.6	16.9	11.6	7	4.1	2.4	1.4
5	13.6	12.3	9.2	6.2	3.9	2.5	1.5
6	9.3	8.6	7	5.1	3.5	2.3	1.6
7	6.4	6.1	5.2	4.1	3	2.1	1.5
8	4.6	4.4	3.9	3.2	2.5	1.8	1.3
9	3.3	3.2	2.9	2.5	2	1.6	1.2
10	2.5	2.4	2.2	2	1.7	1.4	1.1

MULTIPLE UNIT FOOTCANDLES						
2.5' from wall (Distance from fixture along wall)			2.5' from wall (Distance from fixture along wall)			
1	21	18.8	21	19.5	12.1	19.5
2	34.1	34.1	34.1	31	24.4	31
3	33.1	34.4	33.1	29.7	26.5	29.7
4	26.7	28.7	26.7	23.7	23.3	23.7
5	19.8	21.7	19.8	17.5	18.5	17.5
6	14.4	15.8	14.4	12.8	14	12.8
7	10.5	11.4	10.5	9.4	10.4	9.4
8	7.8	8.3	7.8	7	7.7	7
9	5.8	6.2	5.8	5.4	5.9	5.4
10	4.4	4.7	4.4	4.1	4.5	4.1

Photometric Multipliers (Nominal Lumen Values)

500 Lumen	750 Lumen	1000 Lumen	1500 Lumen	2000 Lumen	2500 Lumen	3000 Lumen	3500 Lumen	4000 Lumen
0.33	0.44	0.54	0.74	1.00	1.24	1.54	1.85	2.15

Multipliers for relative lumen values with other series models.

Color Finish Multipliers

Finish code	C	H	W/WB	BB
Finish	Specular Clear	Semi-Specular	Matte White White Baffle	Black Baffle
Multiplier	1.00	0.94	0.88	0.76

Multipliers for relative lumen values with other color finishes.

CCT Multipliers - 80CRI

2700K	3000K	3500K	4000K	5000K
0.89	0.96	1.00	1.03	1.03

Multipliers for relative lumen values with other series color temperatures.

CCT Multipliers - 90CRI

2700K	3000K	3500K	4000K	5000K
0.76	0.85	0.89	0.93	0.93

Multipliers for relative lumen values with other series color temperatures.

Note: Refer to IES files for more product data.

Energy and Performance Data

COLOR METRICS - TM-30-15 & CRI/CIE (3500K)

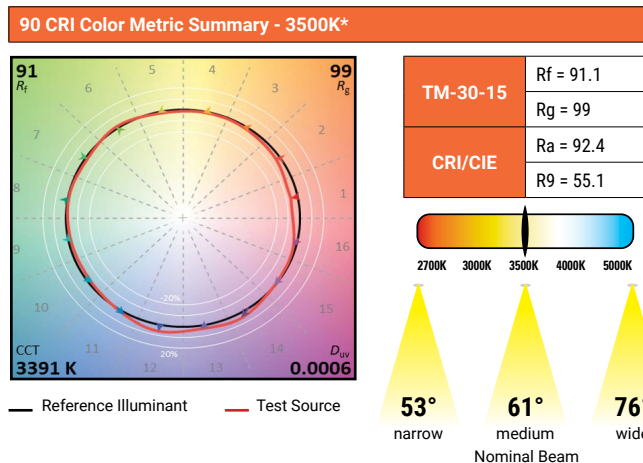
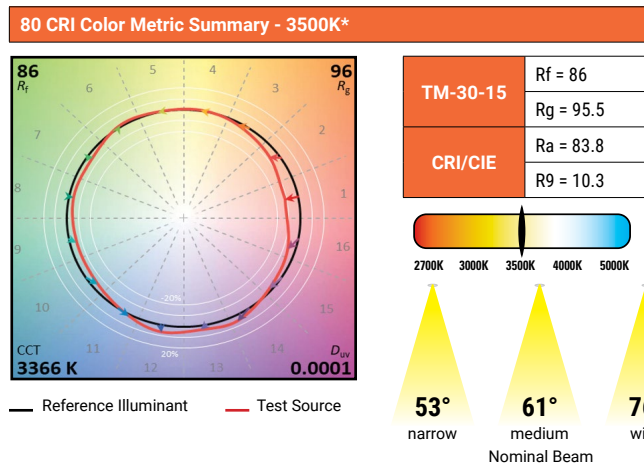

ENERGY DATA

Series	500 lumen		750 lumen		1000 lumen		1500 lumen		2000 lumen	
	120V	277V	120V	277V	120V	277V	120V	277V	120V	277V
Input Voltage 120-277VAC	120V	277V	120V	277V	120V	277V	120V	277V	120V	277V
Input Current (A)	0.051	0.026	0.067	0.036	0.083	0.039	0.119	0.053	0.171	0.077
Input Power (W)	6.1	6.5	7.9	8.3	10	10.4	14.5	14.5	20.9	20.6
In-rush (A)	1.9	8.4	2	8.4	2.2	8.5	2.7	8.5	2.1	9.7
Inrush duration (μs)	251	135	237	133	250	134	250	139	245	131
THD (%)	6.2	13.5	7.4	8.8	5.4	10.3	10	6.7	6.5	7.9
PF	≥ 0.99	≥ 0.9	≥ 0.98	≥ 0.92	≥ 0.99	≥ 0.95	≥ 0.99	≥ 0.97	≥ 0.99	≥ 0.96

Series	2500 lumen		3000 lumen		3500 lumen		4000 lumen	
	120V	277V	120V	277V	120V	277V	120V	277V
Input Voltage 120-277VAC	120V	277V	120V	277V	120V	277V	120V	277V
Input Current (A)	0.23	0.103	0.24	0.107	0.292	0.152	0.351	0.159
Input Power (W)	27.5	27.5	28.6	28.5	34.6	35.1	42.1	42.1
In-rush (A)	2.5	5.6	2.5	11.6	3.4	13.9	3.1	14.7
Inrush duration (μs)	232	123	216	111	183	95	200	98
THD (%)	6.5	8.1	7.8	8.3	5.6	10	4.1	9.5
PF	≥ 0.99	≥ 0.96	≥ 0.99	≥ 0.96	≥ 0.99	≥ 0.93	≥ 0.99	≥ 0.94

Minimum starting temperature -30°C (-22°F)
(Nominal input 120-277VAC & 100% of rated output power)

Sound Rating: Class A standards

Connected Solutions



WaveLinx LITE Wireless Node - WLN

WaveLinx LITE devices only compatible with the WaveLinx LITE system.

- Intuitive Android™ or Apple® iOS® app for basic system code compliant set up and configuration via Bluetooth
- Up to 28 unique areas per project site (WaveLinx LITE Bluetooth network)
- Up to 50 devices for an area, any one of 16 control zones, up to 6 occupancy sets, and custom lighting scenes
- Refer to the WaveLinx system specifications for details

WaveLinx mobile app settings



WaveLinx LITE Wireless Node (WLN) Wiring Diagram

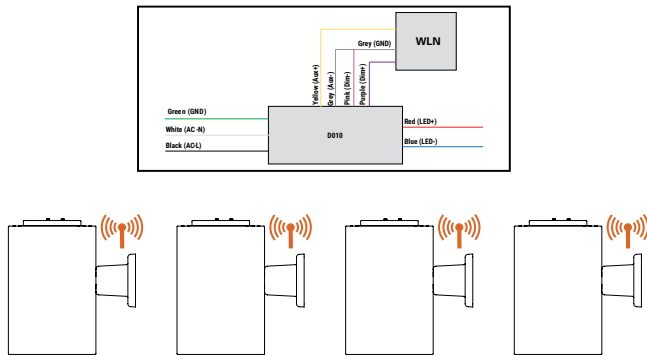

WaveLinx LITE Bluetooth Enabled System



WaveLinx PRO Wireless Node - WPN

WaveLinx PRO devices only compatible with the WaveLinx PRO system.



- WaveLinx Wireless functionality configures zones and customizes settings from one secure mobile app
- Automatic code commissioning that meets the strictest codes
- Fixtures and sensors integrate with WaveLinx Area Controller, Wall Stations, and Control Devices
- Stand-Alone Offices or Entire Building Network Installations

WaveLinx mobile app settings

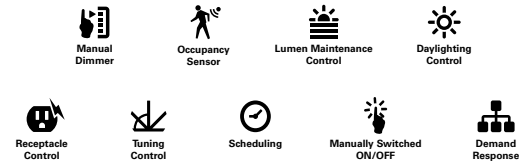

Downlights with wireless communication
Highly efficient LED fixtures

WaveLinx Area Controller
Provides centralized coordination of multiple area control options

Wireless Wall Station/Receptacle
Provides customized wireless control of each area

Mobile Applications
Provides personalized, local control from a tablet or smartphone

WaveLinx PRO Wireless Node (WPN) Wiring Diagram

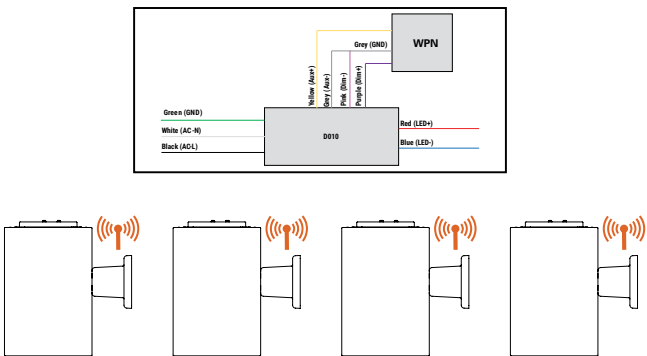

WaveLinx CORE Building Management Integration

