

Project		Catalog #		Type	
Prepared by		Notes		Date	

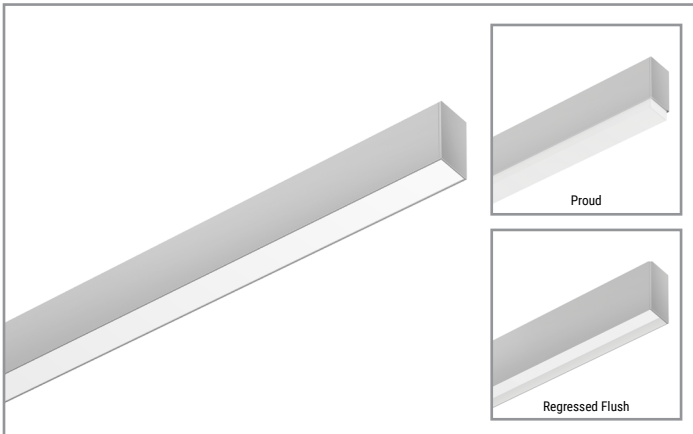

NeoRay

Define 3

3" LED
Surface
Direct

Typical Applications

Office • Education • Healthcare • Hospitality • Retail

Product Certification



Product Features



Interactive Menu

- Order Information [page 2](#)
- Product Specification [page 3](#)
- Photometric Data [page 4](#)
- Performance Data [page 6](#)
- VividTune [page 7](#)

Top Product Features

- Surface Mount Slot family in 2", 3", 4" and 5" housing sizes
- Specifiable to the nearest foot
- Satin, Asymmetric and Drop Direct Lensing available
- Independently specifiable Direct / Indirect lumen packages
- 0-10V dimming standard; DALI dimming available
- 2700K, 3000K, 3500K, 4000K, and 5000K correlated color temperatures available
- Options to meet Buy American Act requirements

Dimensional and Mounting Details

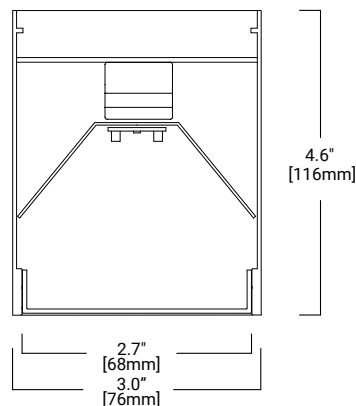

Standard Housing

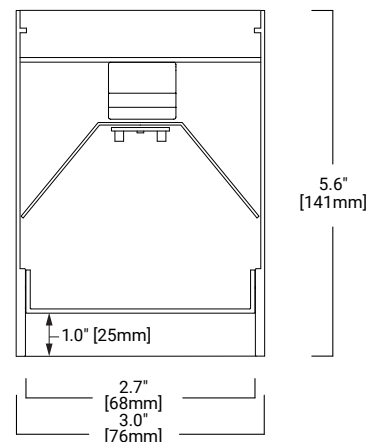

Regressed Housing

additional product diagrams

Order Information

SAMPLE ORDER NUMBER: **S123DS-C340D835JB-4F0-1-UDD-A-W-WPS**

Icon Key: Grey bar denotes available with 10-Day Quick Spec
 ∅ Consult factory for availability

Domestic Preference	Series	Light Engine	Lumen Package Down (Lms/ft)	CRI	LED CCT	Ceiling Type	Luminaire Length (Ft)	Max section length
[Blank] =Standard BAA =Buy American Act	QS-S123DS = Define 3 Direct Surface Quick Spec S123DS =Define 3 Direct Surface S123RDS =Define 3 Regressed Direct Surface	-C=Core -H=High Performance -V=VividTune ∅	340D =340 Lms/ft (2.9W/ft) 560D =560 Lms/ft (4.8W/ft) 775D =775 Lms/ft (6.7W/ft) 1000D =1000 Lms/ft (8.8W/ft) 1165D =1165 Lms/ft (10.6W) ___D=Custom Lms/ft ∅	8=80 9=90	27=2700K 30=3000K 35=3500K 40=4000K 50=5000K 2765=2700K-6500K 3050=3000K-5000K	JB =Gypsum Board, Junction Box, Structure T1 =15/16" T-Grid (ETG) T9 =9/16" T-Grid (FTG) TS =9/16" Slot (STG), Tegular (FTT), Interlude (ITG)	___F0=Nominal length 4F0 = 4' Nominal Length 8F0 =8' Nominal Length ___F0=4' Incremental Run (e.g. 40F0 = 40' 0")	(blank) =12ft (std) /8 =8ft
Notes Only product configurations with this designated prefix are built to be compliant with the Buy American Act of 1933 (BAA). Please refer to DOMESTIC PREFERENCES website for more information. Components shipped separately may be separately analyzed under domestic preference requirements.	Notes RDS regress of 1" will add an additional 1" to fixture depth.	Notes See performance table for add'l details. Light engine must be consistent across run length. V option requires lumen package of 775 lms/ft or greater.	Notes 3500K/80CRI/DIP/F Lens. Please refer to scaling data or other variables. For custom lumen output, please refer to additional information on page 3. 340 Lms/ft not available on 2ft fixture length	Notes Additional lead-time and cost may apply for 927, 930, 935 and 940 configurations. 2765/3050 VividTune configurations require V light engine and W2A driver.	Notes	Notes	Notes Minimum fixture length is 2ft. Specify to nearest foot in length.	Notes Individual fixtures configured as 12ft max by default. Continuous runs configured as 8ft max (12ft not available).

	Additional Section Wiring	Voltage	Driver Type	Shielding Down
-1=Single Circuit -S=Secondary Circuit	E =Emergency Circuit B1 =7W 120-277V EM battery pack B2 =14W 120-277V EM battery pack B3 =6W UNV Integral T =UL924 EPC Emergency Bypass Relay	-U=Universal (120V-277V) -1=120V -2=277V -3=347V	DD =Standard 0-10V Dimming (1%-100%) 5L =Fifth Light DALI (1%-100%) LH =Lutron HiLume (LDE1 series) 1%-100% EcoSys W2A =White Tuning, 0-10V Dimming (VividTune only)	-F=Satin White Diffuser -D=Satin Drop diffuser -A=Asymmetric Diffuser -G=Graze Optic
Notes Secondary circuit similar to A/B switching. Price adder applies for "S" configuration.	Notes Battery available on fixture ≥ 4ft in length. B1-B2 and T options not compatible with 347V. Standard battery 4ft battery section located in the beginning of the fixture, but can be relocated using the linear product configurator. When configured with secondary circuit, battery test switch will be located in a plate on the direct side of the fixture.	Notes 347V only available with DD driver option.	Notes DD driver is standard. For non-dimming applications, the driver will default to full brightness if no connection is made to the capped dimming wires in the field.	Notes All lensing options are snap-in lenses.

Finish	Integrated Sensor
W = White S = Silver B = Black RR = Real Red OO = Oasis Orange YY = Yippee Yellow GG = Gracious Green CC = Cyprus Cyan TT = Totally Turquoise BB = Biosphere Blue PP = Perfect Purple VV = Vacation Violet MM = Magic Magenta C = Custom Color (RAL) CM = Custom Color (Match)	[Blank] =None WaveLinx Wireless -WPS = WaveLinx Pro Integrated Sensor (formerly WAA) -WLS = WaveLinx Lite Integrated Sensor (formerly WAB) Other -LWIPD1=Enlighted Integrated Sensor
Notes Custom Colors (C and CM) are available as ETO. Performance is based off White (W) and may vary with selected finish.	Notes WaveLinx Wireless Sensors are available with (DD) driver option only. Enlighted Sensor is available with (5L) driver option only. Refer to Sensor Placement section for additional details. Integrated Sensors are available with Single Circuit (1) option only. Integrated Sensors combined with Emergency Circuit (E) require one UL924 Bypass Relay (T) per emergency fixture. Integrated Sensors combined with a Battery (B) are available with individual Direct/Indirect (DI) luminaires >4ft in length. Integrated Sensor options with Regressed or Drop lenses available as ETO. Tilemount Sensor is recommended.

Product Specifications

Construction

- Available in Flush and Regressed Housing
- Precision cut housing extruded from 6063 aluminum
- Precision cut & welded end-caps ensure a robust and clean construction
- Nominal 2'-12' illuminated sections used in individual fixtures and 2'-8' illuminated sections used in continuous runs

Finish

- Electrostatically applied polyester powder coat paint

LED Module

- Modular LED tray assembly comprising reflector and light engine with quick disconnect wire-harness for ease of installation and maintenance over the life of the luminaire

Light Engine

- Offered with two next generation Neo-Ray light engines delivering industry leading efficacy and long-life
- LED's are available in 2700K, 3000K, 3500K, 4000K or 5000K
- CRI options of either ≥80CRI or ≥90CRI (Lumen output will be affected - please refer to the lumen adjustment factor table)

LED Drivers

- LED system coupled with electrical driver
- Traditional electronic drivers are available for 120-277V and 347V applications

Controls and Integrated Sensors

- Equipped standard with a 0-10V continuous dimming driver. Compatible with most standard dimming devices
- Additional control types are available (DALI & Lutron) at an additional cost
- WaveLinX and Enlighted wireless sensors as well as stand-alone sensors available

Mounting

- Surface

Lengths

- Available in any length (2ft min) with a resolution of 1 foot. Max section length of 12ft (8ft max used on continuous runs and available for individual fixtures)
- Additional fixture lengths are available please consult factory. All lengths are nominal and do not include end caps.

Corners and Transition Pieces

- Corners and other transition pieces are fully luminous
- Constructed using precision mitered housing and lens components
- Extrusions are welded to ensure a precise and robust assembly
- Standard 90° horizontal corners as well as custom corners are available
- Consult online linear configurator or the factory for precise corner locations and for ordering
- Alternative transition pieces such as T's, Y's, X's, etc. are also available ∅

Direct Snap-In Lensing Options

- Satin Flush - Flush, high diffusion glare-free lens
- Satin Drop - 1" Drop, high diffusion glare-free lens
- Asymmetric - Flush, low-glare Asymmetric lens
- Flush options ship with our patent-pending underlens solution, the proud lens ships with an injection molded end cap to eliminate light leak

Reflectors

- Precision formed cold-rolled steel reflectors with high reflectivity
- Ultra high reflectivity used with High Performance light engine

Lumen Maintenance

- 90% (L90) of initial light output at 61,000+ hrs
- 70% (L70) of initial light output at 237,000+ hrs
- Derived from TM-21 standard @25°C for worst case operating conditions

Custom Lumen Output

- Custom lumen output expressed option in Lumens per foot (e.g. -725D for 725 Lms/ft down). Refer to additional detail on page 4.

Electrical

- Dimming provided as standard
- Dimming wires capped with wire-nuts for non-dimming applications
- Optional battery backup options provided
- Default battery location is internal to fixture
- Default emergency section is 4ft in length and located at the beginning of the fixture unless designated elsewhere
- Estimated lumen output = battery wattage * min efficacy (see performance table)
- The EPC option will bypass local controls and dimming upon loss of normal power. This option is required when the fixture has both integrated sensors and emergency circuiting

Integrated Sensors

- Please reference page 5 for details

Weight

- 3.6 lbs per foot

Approvals

- cULus - listed for damp locations
- Meets NYC requirements
- Meets CCEC requirements
- Tested to IESNA LM-79 and LM-80
- Can be used for State of California Title 24 high efficacy luminaire
- DesignLights Consortium® Qualified and classified for DLC Standard and DLC Premium, refer to www.designlights.org for details and listed configurations.

Warranty

- Five year warranty standard.

Standard Finish Options

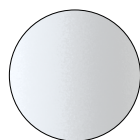

W - White

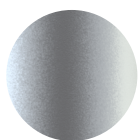

S - Silver



B - Black



RR - Real Red
RAL 3020
Gloss



OO - Oasis Orange
RAL 2004
Gloss



YY - Yippee Yellow
RAL 1018
Gloss



GG - Gracious Green
RAL 6018
Gloss



CC - Cyprus Cyan
RAL 6027
Gloss

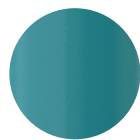

TT - Totally Turquoise
RAL 5018
Gloss

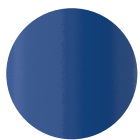

BB - Bioshere Blue
RAL 5017
Gloss



PP - Perfect Purple
RAL 4005
Gloss



VV - Vacation Violet
RAL 4008
Gloss



MM - Magic Magenta
RAL 4010
Gloss

RAL & custom colors available as ETO



Optic Options

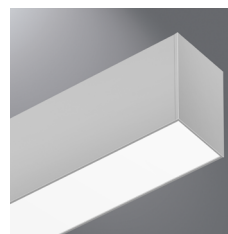

Standard Flush Lens

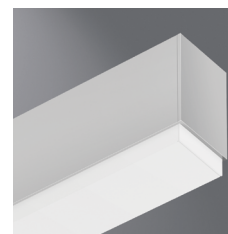

Standard Proud Lens

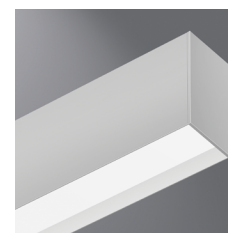

Regressed Flush Lens



Asymmetric Lens

Photometric Data

 [View IES files](#)

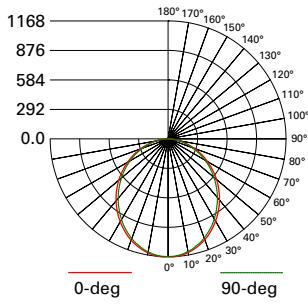

FILE NAME:
S123DR-S775D835-GYP4F0-1-UDD-F-W
LUMENS: 3027 Lms
LPW: 114.7 LPW
CCT: 3500K
WATTS: 26.4 W
TEST NUMBER: G3-1802-639-11

SATIN FLUSH LENS

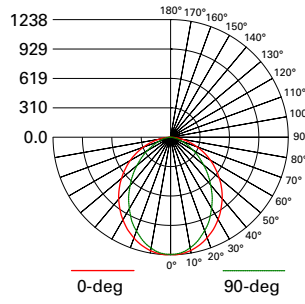

FILE NAME:
S123RDR-S775D835-GYP4F0-1-UDD-F-W
LUMENS: 2786 Lms
LPW: 105.5 LPW
CCT: 3500K
WATTS: 26.4 W
TEST NUMBER: G3-1802-639-25

SATIN REGRESSED DIFFUSER

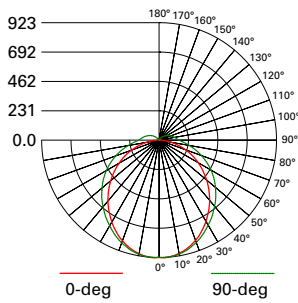

FILE NAME:
S123DR-S775D835-GYP4F0-1-UDD-D-W
LUMENS: 3085 Lms
LPW: 116.9 LPW
CCT: 3500K
WATTS: 26.4 W
TEST NUMBER: G3-1802-639-15

SATIN DROP LENS

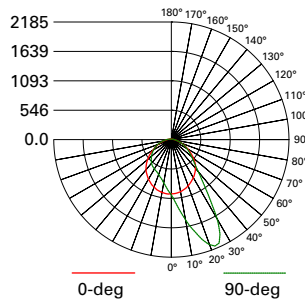
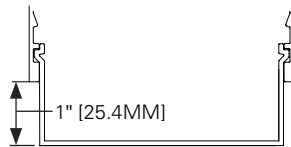

FILE NAME:
S123DR-S775D835-GYP4F0-1-UDD-A-W
LUMENS: 3115 Lms
LPW: 118.0 LPW
CCT: 3500K
WATTS: 26.4 W
TEST NUMBER: G3-1802-639-20

ASYMMETRIC FLUSH LENS

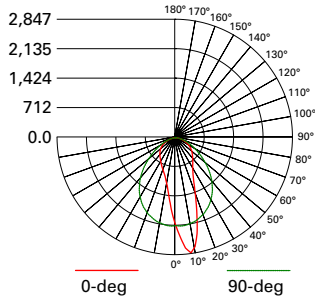

FILE NAME:
S123DR-S775D835-X4F0-XX-UDD-G-W
LUMENS: 3462.5 Lms
LPW: 134.7 LPW
CCT: 3500K
WATTS: 25.7 W
TEST NUMBER: P646650

GRAZE OPTIC FLUSH

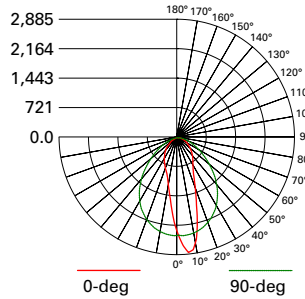

FILE NAME:
S123RDR-S775D835-X4F0-XX-UDD-G-W
LUMENS: 3231.3 Lms
LPW: 124.3 LPW
CCT: 3500K
WATTS: 26 W
TEST NUMBER: P646695

GRAZE OPTIC REGRESSED

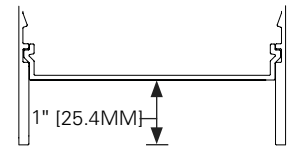

Photometric Overview and Performance Data

Direct Performance Per Linear Foot at 3500K/80CRI

Nominal Output	Standard		High Performance		VividTune	
	W/ft	lm/W	W/ft	lm/W	W/ft	lm/W
340	2.9	124	2.9	126	3	120
560	4.8	125	4.4	130	4.9	121
775	6.7	122	6.1	131	6.7	119
1000	8.8	120	8.1	128	8.9	116
1165	10.6	115	9.7	123	10.7	112

Lumen Adjustment Factors

Direct Optic	Adjustment Factor
Flush Frosted Lens (F)	1.000
Asymmetric (A)	1.029
Drop (D)	1.019
Regress Frosted (RD w/ F)	0.920
Wall Graze (G)	1.119

LUMEN ADJUSTMENT CALCULATIONS

Example 1 - Adjusted Lumen Output

Nominal Lumen Output selected = 1025 lms/ft (based on standard of 3500K/80CRI)
Lumen Adjustment Factor = 0.801 (2700K/90CRI desired)

Adjusted Lumen Output = Nominal Lumen Output x Lumen Adjustment Factor
Adjusted Lumen Output = 1025 lms/ft x 0.801 = 821 lms/ft

Example 2 - Custom Lumen Output based on Required Lumens Per Foot

Total light output (4ft) requirement of 2800 lms, desired CCT and CRI of 4000K/80CRI

Total required lumens per foot @ 4000K = 2800 lms / 4 ft = 700 lms/ft
Lumen Adjustment Factor = 1.018 (Requirement based on 4000K / 80CRI)

Total required lumens per foot @ 3500K / 80CRI = 700 lms/ft ÷ 1.018 = 688 lms/ft

Estimated efficacy = 121 LPW (find nearest value using table above)
Estimated power consumption = 688 lms/ft ÷ 121 lm/W = 5.69 W/ft

Custom Lumen Output

Total Light Output Range (lms/ft)

CCT	Lumen Adj Factors		Direct Output Range	
	80CRI	90CRI	80CRI	90CRI
2700K	N/A	0.792	N/A	269-923
3000K	0.943	0.815	321-1099	277-949
3500K	1.000	0.861	340-1165	293-1003
4000K	1.010	0.892	343-1177	303-1039
5000K	1.010	0.892	343-1177	303-1039

If your requirement is expressed in power consumption (W/ft) rather than light output, you can use the power to lumen output curves to convert power consumption to light output for specification. Efficacy for custom lumen outputs can be estimated using lumen output curves or with the use of our online custom lumen output tool.

Corner Transitions

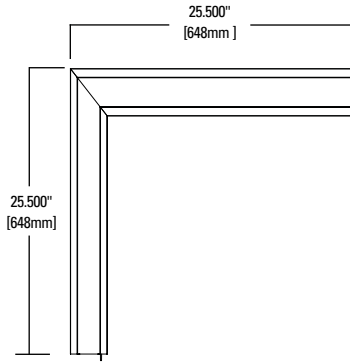

Integrated Sensor Details and Placement

Sensor Type	Wireless	Sensor Integration	Sensor Mounting	Ordering Code
WaveLinx Pro	Yes	Integral to Fixture	Mounted in solid cover	WAA
WaveLinx Lite	Yes	Integral to Fixture	Mounted in solid cover	WAB
Enlighted	Yes	Integral to Fixture	Mounted in illuminated lens	LWIPD1
Stand-Alone SVPD1	No	Integral to Fixture	Mounted in solid cover	SVPD1

Optional standalone and wireless connected integrated sensors require use of the DD (0-10V) driver. WaveLinx and Enlighted sensors require additional system hardware (not provided) for full functionality.

Standard sensor layout is shown below. Please refer to sensor coverage pattern diagrams to ensure proper coverage for the application. Standard configurations are available in both individual fixtures and in continuous runs. Default spacing is based on the maximum fixture length of 12ft and can be changed to 8ft sensor spacing for additional coverage by selecting the 8ft max fixture length option when ordering.

For additional information integrated sensors and connected lighting, please visit [Cooper Lighting Solutions's Connected Lighting Website](#).

- Standard Sensor with Luminaire Control
- Auxiliary Sensor used for Sensor Coverage (wireless systems only)

INTEGRAL SENSOR

≤8ft Individual

>8ft Individual

Note: When 8ft max section length is used on individual fixtures > 8ft, sensor placement follows logic for continuous run.

Beginning of Run (BOR)

Intermediate Section (INT)

End of Run (EOR) > 4ft

End of Run (EOR) ≤ 4ft



Define 3 Pendant LED with VividTune Tunable White

VividTune tunable white luminaires deliver high-quality light in a broad range of continuously variable color temperatures and intensities. Create a dynamic environment by adjusting the ambient light warmer or cooler to influence mood, support the task at hand, or create a dramatic ambience. The ability to control correlated color temperature and intensity separately using simple controls is the next evolution of LED lighting for the commercial, educational, healthcare and hospitality space. The unparalleled flexibility and number of available lighting environments enable users to find the right light with tunable white.

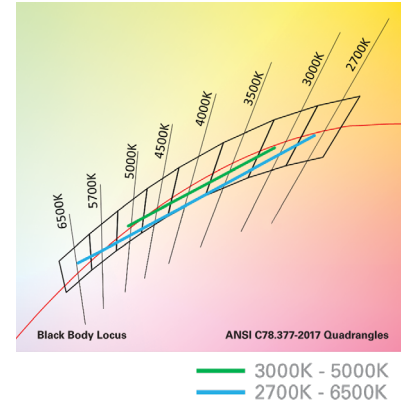

Performance Data*

Tunable White - Lumen Adjustment Factors				
CCT	3000K-5000K		2700K-6500K	
	80 CRI	90 CRI	80 CRI	90 CRI
2700K	-	-	0.868	0.741
3000K	0.894	0.736	0.893	0.771
3500K	0.946	0.804	0.924	0.809
4000K	0.993	0.868	0.944	0.835
4500K	1.002	0.883	0.961	0.857
5000K	1.002	0.883	0.974	0.874
6500K	-	-	0.988	0.897

Example of Approximate Lumen Calculation			
	Standard Catalog #	VividTune 80 CRI Catalog #	VividTune 90 CRI Catalog #
CCT Setting	S123DS-C1000D835-X-UDD-F-W	S123DS-V1000D83050-X-UW2A-F-W	S123DS-V1000D93050-X-UW2A-F-W
3000K	-	3576	2944
3500K	4000	3784	3216
4000K	-	3972	3472
4500K	-	4008	3532
5000K	-	4008	3532

Controlling VividTune Tunable White

VividTune luminaires make tunable white more accessible by using simple and familiar controls. From wall dimmers to wireless controls, VividTune tunable white luminaires are compatible with industry standard 0-10V dimming controls. A single 0-10V dimming input is used to control intensity (brightness) while a second 0-10V dimming input is used to adjust CCT. For suggested control configurations, go to www.cooperlightingsolutions.com for tunable white application guides.

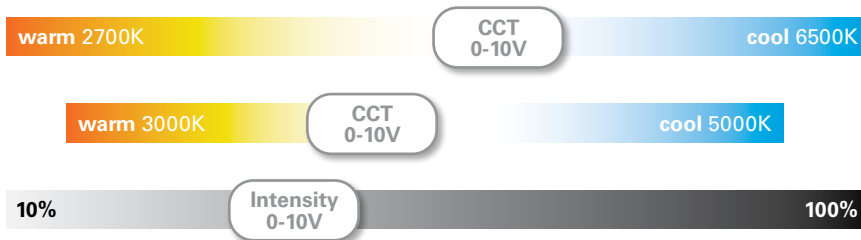

Example of Lumen Adjustment Calculation

S123DS-V1000D83050-X-UW2A-F-W at 80 CRI tuned to 3500K

Adjusted Lumen = published lm x adjusted lm factor

Adjusted Lumen = 4000 x 0.946

Adjusted Lumen = 3784 lm

* Lumen adjustment factors are for reference and may be different for each product selected. Refer to IES files for actual performance data on each.